

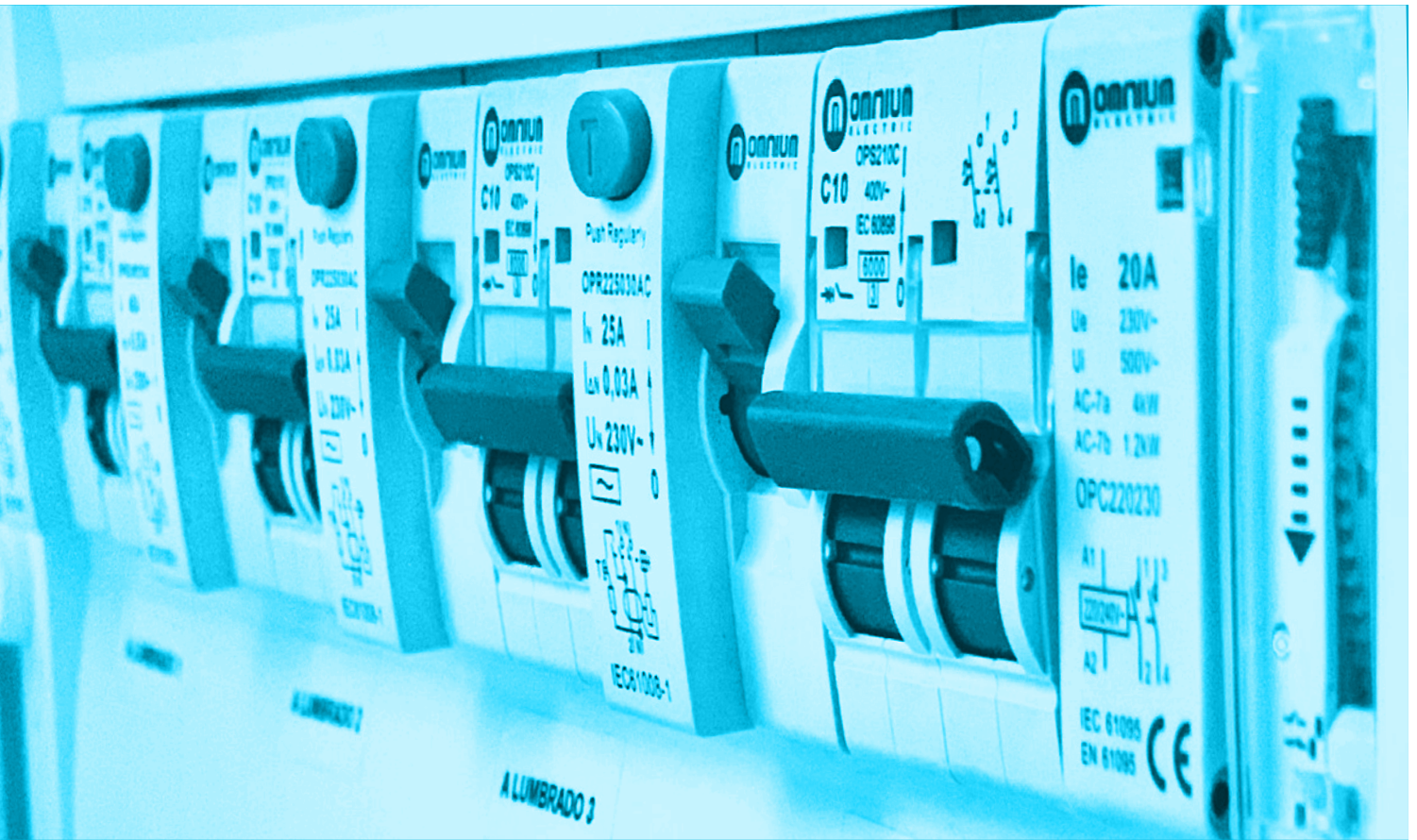

**ONNIUM**  
ELECTRIC

**MATERIAL ELÉCTRICO DE INSTALACIÓN ELECTRICAL INSTALLATION MATERIALS**





**FEMPA**  
FEDERACION DE EMPRESARIOS DEL  
METAL DE LA PROVINCIA DE ALICANTE











Omnium Electric Iberia, S.L. ubicada en España y con un claro enfoque internacional se dedica al diseño, fabricación y comercialización de productos de instalación eléctrica. Nuestro objetivo es fabricar y comercializar productos de alta calidad a escala mundial y a precios competitivos. Ofrecemos a nuestros distribuidores la oportunidad de aumentar su participación de mercado y maximizar sus márgenes de beneficio.

Omnium Electric Iberia se enorgullece de poseer la certificación ISO 9001: 2015 y ha superado un proceso de evaluación integral que incluye: desarrollo del sistema de gestión de la calidad, revisión de la documentación del sistema de gestión, pre-auditoría, evaluación inicial y resolución de no conformidades. todo lo cual nos permite identificar acciones correctivas que eliminen no conformidades en el estándar de gestión de calidad. Es un logro desmesurado que demuestra que estamos verdaderamente capacitados para comprender las necesidades de nuestros clientes y trabajar con ellos para ofrecer soluciones de alta calidad, al mismo tiempo que revisamos y mejoramos continuamente la forma en la que trabajamos. Esta certificación no solo anticipa las demandas de nuestros clientes, sino que también revela nuestro compromiso de brindar productos y servicios de calidad a todos nuestros clientes actuales y potenciales. Nuestro equipo de profesionales tiene la capacidad de hacer que las cosas sucedan, desarrollando y manteniendo una red de distribución eficiente con soluciones hechas a medida. La estrategia de Omnium es agregar valor a nuestros asociados y clientes convirtiéndose en una marca reconocida por su calidad y servicio a nivel mundial.

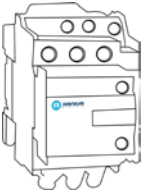
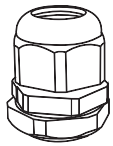
*Omnium Electric Iberia, S.L. is based in Spain but has a clear international focus dedicated to the design, manufacture and commercialization of electric installation products. Our objective is to manufacture and commercialize high quality electrical products on a global scale and at competitive prices. We offer our distributors the opportunity to increase their market share as well as maximize their profit margins.*

*Omnium Electric Iberia is an extremely proud holder of the ISO 9001:2015 certification and has endured a comprehensive evaluation process that included: quality management system development, a management system documentation review, pre-audit, initial assessment, and clearance of non-conformances, all of which work to identify corrective actions that eliminate non-conformances in the quality management standard. It is an inordinate achievement that shows we are truly endowed in understanding our client's needs in working with them to deliver high quality solutions, at the same time continuously reviewing and improving the way we work. This certification not only anticipates the demands of our customers, but also reveals our commitment to providing quality products and services to all our existing and prospective customers. Our approachable team of professionals have the ability to make things happen, developing and maintaining an efficient distribution network with "taylor made" solutions. Omnium's strategy is to add value to our associates and clients by becoming a brand-name recognized for its quality and service worldwide.*

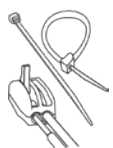

 <p><b>protec</b></p> <p><b>Aparamenta modular</b> <i>Modular DIN rail equipment</i></p>	<p><b>4</b></p>	 <p><b>acerbox</b></p> <p><b>Amarios metálicos IP66</b> <i>Metallic enclosures IP66</i></p>	<p><b>112</b></p>
 <p><b>omnicontrol</b></p> <p><b>Protección, señalización y control</b> <i>Protection, signalling and control</i></p>	<p><b>42</b></p>	 <p><b>aquatite</b></p> <p><b>Accesorios estancos</b> <i>Sealing Accessories</i></p>	<p><b>116</b></p>
 <p><b>optima</b></p> <p><b>Cajas de distribución IP30 - IP40</b> <i>Distribution boxes IP30 - IP40</i></p>	<p><b>100</b></p>	 <p><b>omniumdata</b></p> <p><b>Datos y telecomunicaciones</b> <i>Data and telecommunications</i></p>	<p><b>132</b></p>
 <p><b>spa</b></p> <p><b>Cajas de distribución IP65</b> <i>Distribution boxes IP65</i></p>	<p><b>104</b></p>	 <p><b>omnifix</b></p> <p><b>Accesorios de fijación</b> <i>Fixing and wiring accessories</i></p>	<p><b>122</b></p>
 <p><b>omnibox</b></p> <p><b>Cajas estancas IP55 - IP65</b> <i>Sealed enclosures IP55 - IP65</i></p>	<p><b>108</b></p>	 <p><b>Información Técnica</b> <i>Technical information</i></p>	<p><b>140</b></p>

Pregúnte sobre nuestros servicios / Ask about our services:

- ✓ **Productos de calidad**  
*High quality product*
- ✓ **Entrega rápida**  
*Fast delivery*
- ✓ **Plazos de pago flexibles**  
*Flexible payment terms*
- ✓ **Atención al cliente y apoyo técnico**  
*Customer service and technical assistance*



Realice su pedido ya! / Place your order now!

+34 865 752 249

pedidos@omnium-electric.com



## protec

La familia Protec está compuesta de interruptores magnetotérmicos, interruptores diferenciales, contactores y todos los accesorios necesarios para cubrir todos los requerimientos técnicos y funcionales de la mayor parte de las aplicaciones de distribución de energía eléctrica de baja tensión. La gama incluye referencias de 1A a 125A con capacidades de corte entre 3kA y 15kA. Podrá consultar todas las referencias de esta serie en la sección de productos de nuestro sitio web.

*The Protec series comprises of MCB's, RCCB's, contactors and all the necessary accessories to cover all technical and functional requirements in most low tension electrical circuit installations. The range includes references from 1A to 125A and 3kA to 15kA. All the references available are displayed in the product section of our website.*

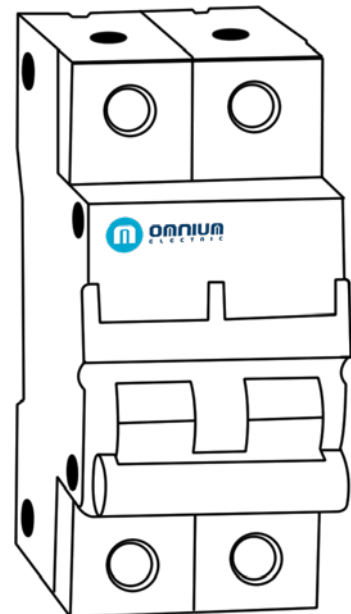



<b>Tablas para la selección de dispositivos e información técnica / Device selection tables and technical information</b>	<b>6</b>	<b>Interruptor horario modular de segmento</b> <i>Modular segment timer switch</i> Referencia / Reference: OPHQ1-P	<b>28</b>
<b>Interruptores automáticos magnetotérmicos</b> MCB's 6 kA, 1-63A Referencia / Reference: OPS	<b>12</b>	<b>Interruptor horario modular de segmento</b> <i>Modular segment timer switch</i> Referencia / Reference: OPHQ3-P	<b>28</b>
<b>Interruptores automáticos magnetotérmicos estrechos</b> 1P+N <i>Single module MCB's</i> 10kA, 1-32A Referencia / Reference: OPF	<b>13</b>	<b>Interruptor modular programable digital</b> <i>Digital modular timer switch</i> Referencia / Reference: OPHD2-PR	<b>28</b>
<b>Interruptores automáticos magnetotérmicos</b> MCB's 10kA, 1-125A Referencia / Reference: OPT	<b>13</b>	<b>Interruptor horario automático modular</b> <i>Modular automatic timer switch</i> Referencia / Reference: OPHSC1D	<b>29</b>
<b>Interruptores automáticos magnetotérmicos</b> MCB's 15kA, 20-125A Referencia / Reference: OPK	<b>14</b>	<b>Relé horario de única función</b> <i>Single function time relay</i> Referencia / Reference: OPHSFT*	<b>30</b>
<b>Interruptores automáticos magnetotérmicos</b> MCB's DC, 10kA, 1-63A Referencia / Reference: OPT	<b>14</b>	<b>Relé horario funciones múltiples</b> <i>Multifunction time relay</i> Referencia / Reference: OPHMFT*	<b>31</b>
<b>Accesorios para magnetotérmicos</b> MCB <i>Accessories for OPS breakers</i> Referencia / Reference: OPA	<b>15</b>	<b>Relé de impulso AC y DC</b> <i>Impulse relay AC and DC, 16A</i> Referencia / Reference: OPIR	<b>33</b>
<b>Detector de arcos eléctricos</b> ARC <i>Fault detection device AFDD</i> Referencia / Reference: OPAFDD	<b>16</b>	<b>Relé de voltaje trifásico</b> <i>3-phase voltage relay</i> Referencia / Reference: OPVR	<b>35</b>
<b>Diferencial incorporado</b> RCBO's 6kA, 6-40A Referencia / Reference: OPW	<b>16</b>	<b>Medidor de energía monofásico de 2 cables</b> <i>Single phase two wire energy meter</i> Referencia / Reference: OPEM2*	<b>37</b>
<b>Interruptores diferenciales</b> RCCB's 10kA, 25-63A Referencia / Reference: OPR	<b>17</b>	<b>Medidor de energía trifásico de 4 cables</b> <i>3-phase four wire energy meter</i> Referencia / Reference: OPEM4	<b>38</b>
<b>Interruptores diferenciales rearmables</b> RCCB's <i>Auto reclosing</i> 10kA, 40-63A Referencia / Reference: OPQ	<b>18</b>	<b>Bases portafusibles modulares</b> <i>Modular fuseholders</i> Referencia / Reference: OPU	<b>39</b>
<b>Interruptores diferenciales tipo B</b> <i>Type B residual current breakers</i> 10kA, 16-63A, Referencia / Reference: OPRB	<b>19</b>	<b>Lamparas de señal modulares</b> <i>Modular signal lamp, 1P, 3P 230V</i> Referencia / Reference: OPL	<b>40</b>
<b>Interruptor de transferencia automática</b> <i>Automatic transfer switch</i> Referencia / Reference: OPATS	<b>20</b>	<b>Bases de enchufe modulares</b> <i>Modular sockets</i> Referencia / Reference: OPG	<b>40</b>
<b>Contactores modulares AC</b> <i>Modular AC contactors</i> 20A, 32A, 40A, 63A, 2P, 3P y 4P Referencia / Reference: OPC	<b>24</b>	<b>Peines, barras de conexión de cobre</b> <i>Copper busbars</i> Referencia / Reference: OPB	<b>41</b>
<b>Protectores de sobrecarga</b> <i>Surge protection devices</i> Referencia / Reference: OPP	<b>26</b>	<b>Bloques repartidores y adaptadores de distribución</b> <i>Terminal distribution blocks and adaptors</i> Referencia / Reference: OPBA* / B*OPUTB*	<b>42</b>

**Consideraciones previas**

Para la correcta elección de las protecciones es necesario conocer no solo las cargas que están conectadas a ellas, sino además las exigencias de la instalación en cuanto al aporte de cortocircuito, condiciones del entorno, la instalación, funciones adicionales que deba proveer, tales como indicaciones de presencia de tensión, falla, funcionamiento, etc. Estas exigencias en general, están determinadas por el ámbito de la aplicación.

Se pueden distinguir tres ámbitos de aplicación de las protecciones que portan exigencias distintivas: el ámbito residencial, el ámbito terciario y el ámbito industrial.

La gama PROTEC responde a las exigencias de cada ámbito. Conocer esas exigencias y elegir el producto correcto es tarea del profesional, proyectista o instalador.

**Initial considerations**

For the ideal choice of circuit protection it is important to know the load that will be connected and the installation requirements such as short circuit capacities, environmental conditions, etc. Additional functions such as indications of tension, faults, function, etc. should also be accounted for. These requirements are generally determined by the purpose of the installation.

There are three distinguished areas of application for the protections that carry distinctive requirements: the residential area, the tertiary area and the industrial area.

The PROTEC range covers the requirements of every area. To know these requirements and to choose the correct product is the task of the professional, designer of the installation or installer.

**Protecciones de circuitos /Circuit protection**  
**Interruptores magnetotérmicos / MCB's**

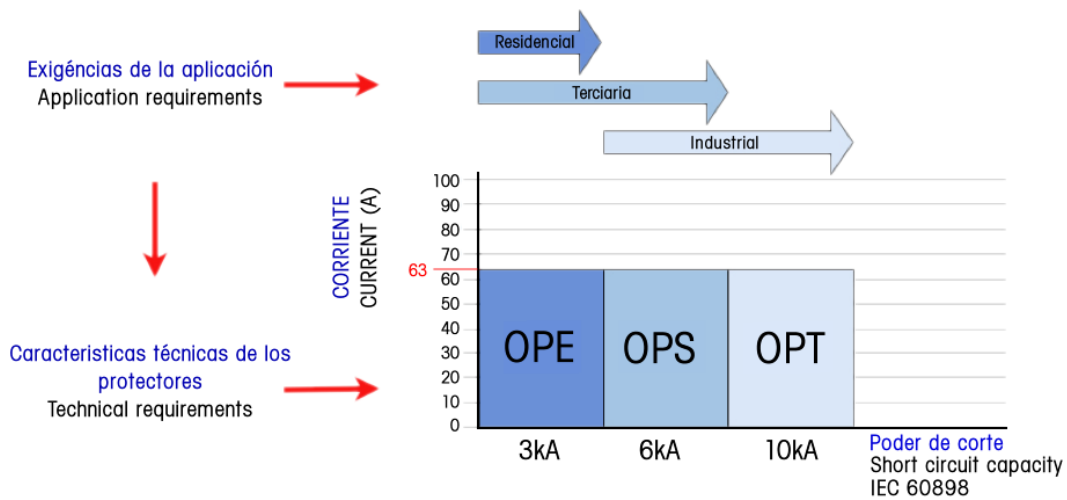

**Protecciones contra contactos directos e indirectos / Protections against direct and indirect contacts**  
**Interruptores diferenciales / RCCB's**

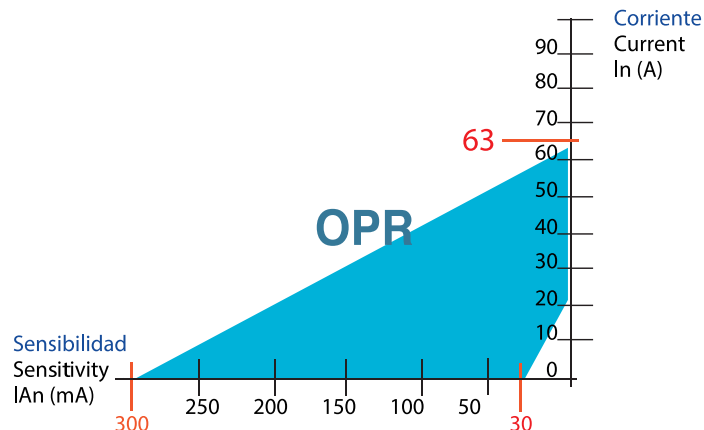

## Interruptores magnetotérmicos / MCB's Referencias / References: OPF, OPS y OPT

### Características de desconexión

Las características de desconexión de los interruptores automáticos magnetotérmicos PROTEC se corresponden a las normas IEC 60898.

Los valores de desconexión se indican en el siguiente gráfico. Características de desconexión según Norma IEC 60898, Tipos B, C y D

### Disconnection characteristics

The disconnection characteristics of the PROTEC range of MCB's correspond to the IEC 60898 standard. The values of disconnection are indicated in the following graph.

Disconnection characteristics as per IEC 60898 standard, Types B, C and D

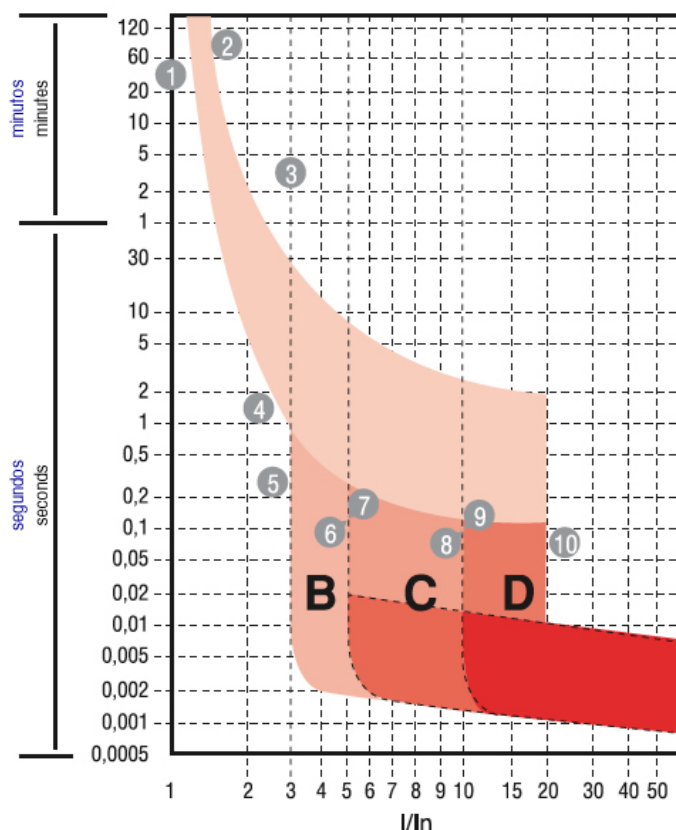

1. Valor constante de la corriente de no desconexión:  
 $I_n t = 1.13 I_n : t > 1h$
2. Valor constante de la corriente de desconexión:  
 $I t = 1.45 I_n : t < 1h$
3.  $2.55 I_n : t < 1m (I_n \geq 32A)$   
 $t < 2m (I_n > 32A)$
4.  $2.55 I_n : t > 1s$
5. Tipo B:  $3 I_n : t \geq 0.1s$
6.  $5 I_n : t < 0.1s$
7. Tipo C:  $5 I_n : t \geq 0.1s$
8.  $10 I_n : t < 0.1s$
9. Tipo D:  $10 I_n : t \geq 0.1s$
10.  $20 I_n : t < 0.1s$

Aplicación según las características de desconexión

Las distintas características de desconexión indican aplicar a los interruptores de curva B para la protección de circuitos con baja carga inductiva. Los interruptores de la curva C son más apropiados para la protección de cables que alimenten aparatos domésticos. La curva D se indica para la protección de cables que alimenten aparatos de elevada corriente de arranque.

1. Constant value of no disconnection current:  
 $I_n t = 1.13 I_n : t > 1h$
2. Constant value of disconnection current:  
 $I t = 1.45 I_n : t < 1h$
3.  $2.55 I_n : t < 1m (I_n \geq 32A)$   
 $t < 2m (I_n > 32A)$
4.  $2.55 I_n : t > 1s$
5. Type B:  $3 I_n : t \geq 0.1s$
6.  $5 I_n : t < 0.1s$
7. Type C:  $5 I_n : t \geq 0.1s$
8.  $10 I_n : t < 0.1s$
9. Type D:  $10 I_n : t \geq 0.1s$
10.  $20 I_n : t < 0.1s$

Application as per disconnection characteristics

The different disconnection characteristics indicate that curve B is applied to provide protection to circuits with low inductive load. Curve C is used for the protection of circuits in domestic installations. Curve D is typically used for the protection of cables feeding appliances with high start current requirements.

**Interruptores magnetotérmicos / MCB's**  
**Referencias / References: OPF, OPS y OPT**

**Información técnica**

**Condiciones de uso:**

1. Altitud sobre el nivel del mar: 2000m
2. Temperatura ambiente: -5°C / +40°C
3. Temperatura media máxima: +35°C
4. Humedad máxima de 50% a 40°C de temperatura. Se permite mayor humedad a temperaturas más bajas.

**Technical information**

**Operating conditions:**

1. Altitude above sea level: 2000m
2. Ambient temperature: -5°C / +40°C
3. Maximum average temperature: +35°C
4. Maximum relative humidity not exceeding 50% at 40°C temperature. Higher humidity acceptable at lower temperatures.

**Productos diseñados para la instalación en carril DIN tipo TH35-7.5D**  
**Products designed to be installed on DIN rail type TH35-7.5D**

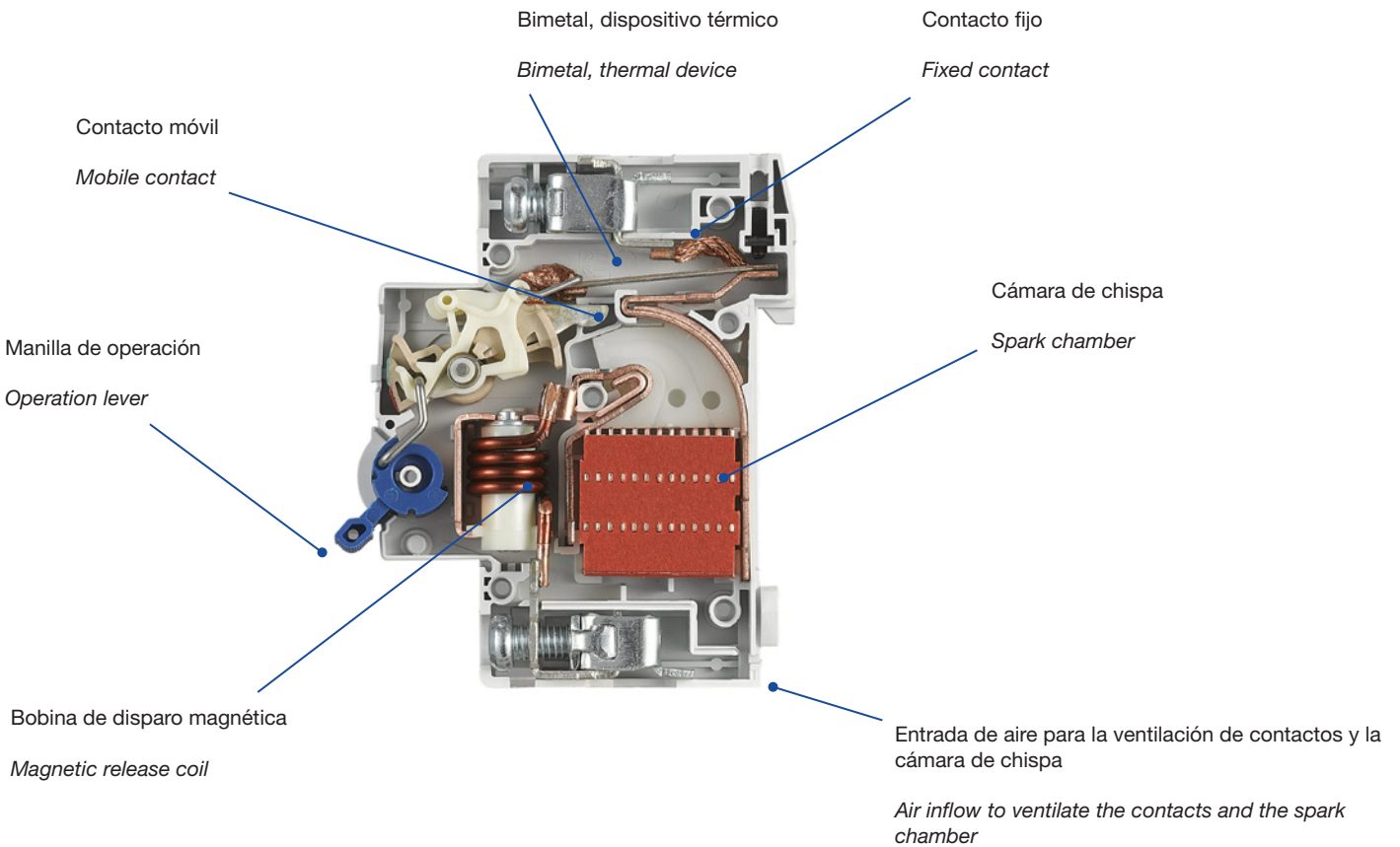
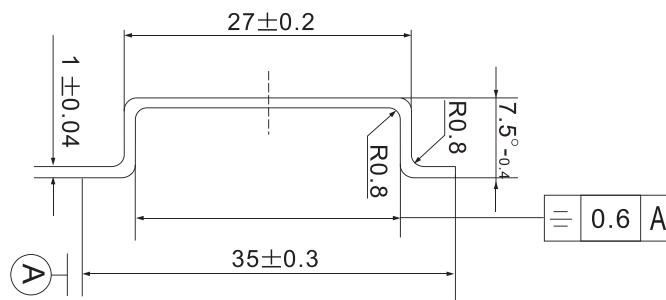



## Interruptores diferenciales / RCCB's Referencia / Reference: OPR

### Información técnica

#### Efectos de la corriente eléctrica sobre el cuerpo humano

La aplicación de la corriente eléctrica sobre el cuerpo humano produce en éste calambres, quemaduras y, en los casos más graves, fibrilación ventricular que puede producir daños irreversibles, con consecuencias fatales.

EFEECTO = Intensidad x Tiempo

La relación Intensidad-Tiempo-Efecto queda reflejada en la Fig.1 En presencia de una protección diferencial, los efectos no alcanzan el nivel de peligro para la vida humana.

### Technical information

#### Effects of electrical current on the human body

The application of electrical current on the human body produces cramps, burns and, in the most serious cases, ventricular fibrillation that can produce irreversible damages, with fatal consequences.

EFFECT = Intensity x Time

The relation Intensity-Time-Effect is shown in Figure 1. In the presence of RCCB protection, the effects do not reach the level of danger to human life highlighting the importance of such devices in electrical installations.

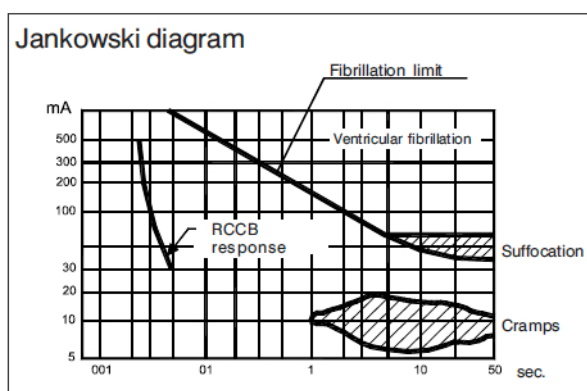

Fig. 1

### Principios de funcionamiento de los interruptores diferenciales

En la Figura 2, vemos el esquema de los componentes de un diferencial monofásico instalado. Toda la corriente que consume el receptor viene por la fase activa y retorna por el neutro, originando en el núcleo flujos opuestos proporcionales a las respectivas intensidades.

### RCCB working principle

In Figure 2, we see the scheme of the components of an installed single-phase RCCB. The current that the recipient consumes comes from the active phase and returns by the neutral, originating in the core opposite proportional flows to the respective intensities.

### Comportamiento sin intensidad de fuga

En el caso de que no exista ninguna derivación a tierra (fuga), toda la intensidad de la fase retorna por el neutro. Por lo tanto, los flujos serán del mismo valor y de sentido contrario, siendo el flujo resultante 0. Un flujo de valor 0 no es capaz de originar ninguna fuerza electromotriz en el arrollamiento secundario.

### Operation with no leakage

When no leakage exists, all the incoming current returns via de neutral conductor. Hence, the total magnetic flux through the toroid core is the result of two equal and opposite fluxes, their sum being 0. This does not induce any voltage in the secondary winding.

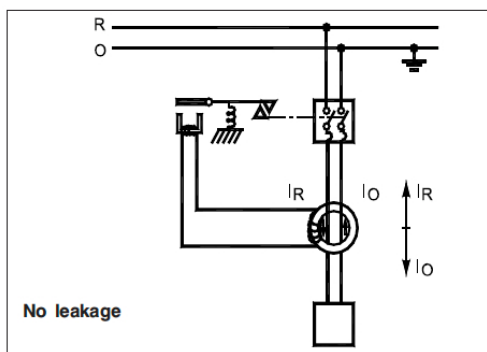

Fig. 2

**Interruptores diferenciales / RCCB's**  
**Referencias / References: OPR**

**Comportamiento con intensidad de fuga**

En el caso de que exista una derivación a tierra (corriente de fuga), por la fase circulará la intensidad que alimenta el receptor I más la intensidad de fuga  $I_f$ , regresando por el neutro solamente la intensidad del receptor, puesto que la intensidad de fuga fluye por la puesta a tierra, que no pasa por dentro del núcleo toroidal, (Ver Figura 3).

La intensidad circulante por la fase será mayor que la intensidad circulante por el neutro.

Los flujos establecidos serán de signo contrario y proporcionales a las intensidades, por tanto uno mayor que otro:  $I_R > I_O$ , existiendo un flujo resultante:  $I_R - I_O = I_f$ .

Este flujo resultante origina una fuerza electromotriz en el secundario del núcleo toroidal que, según su valor y el de la sensibilidad del diferencial, será suficiente para despolarizar el relé y liberar el gatillo de desconexión del interruptor.

El fenómeno es idéntico, sea cual sea la sensibilidad de los diferenciales: 30, 100, 300 o 500 mA.

**Lo que no protege el interruptor diferencial**

El interruptor diferencial entra en funcionamiento cuando hay una fuga en el circuito de un nivel igual, al menos, a su sensibilidad. Las corrientes de carga, normales o no, no son detectadas por el interruptor diferencial. Para proteger los circuitos contra cortocircuitos o sobrecargas, tienen que ser añadidos disyuntores, adecuadamente calibrados al circuito y necesidades de carga.

La Figura 4. ilustra una condición donde hay contacto accidental de un ser humano con ambos conductores que actúan como una carga en el circuito, sobre una superficie aislada con un valor de resistencia a tierra.

En este caso, no se genera ninguna fuga a tierra, con toda la corriente de la fase entrante devuelta por el neutro. Por lo tanto, como no existe ningún desequilibrio, el interruptor permanecerá en funcionamiento y la persona recibirá la descarga de lleno, a través de su cuerpo.

**Operation under leakage condition**

In case a leakage of current to earth, the phase will carry the intensity that feeds the recipient I plus the intensity leakage  $I_f$ , returning by the neutral only the intensity of the recipient; since the intensity of leakage flows through earth, which does not pass within toroidal core, (See Figure 3).

The circulating intensity through the phase will be greater than the circulating intensity through the neutral.

The established flows will be of opposite sign and proportional to the intensities, therefore one greater than the other:  $I_R > I_O$ , with an existing resultant flow:  $I_R - I_O = I_f$ .

This resultant flow generates an electromotive force in the secondary toroidal core that, according to its value and that of the sensibility of the RCCB, will be sufficient to depolarize the relay and therefore trip the RCCB.

The phenomenon is identical for all sensitivities: 30, 100, 300 or 500 mA.

**What the RCCB does not protect against**

The RCCB works when there is a leakage in the circuit of a level equal at least to its sensitivity. Load currents, whether normal or not, are not detected by the RCCB. To protect circuits against short circuits or overloads, circuit breakers must be added, such that they are adequately rated to the circuit and load conditions.

Figure 4. illustrates a condition where there is accidental contact of a human being with both conductors thereby acting as a load in the circuit, this happening on an insulated surface with a very high value of earthing resistance.

In this case, no earth leakage will appear, with all of the incoming phase current returning through the neutral. Therefore, as no imbalance exists, the RCCB will remain in operation and the person will receive the full effect through his or her body.

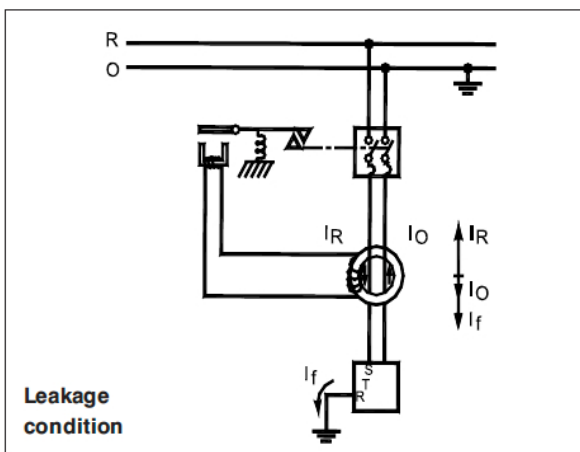

Fig. 3

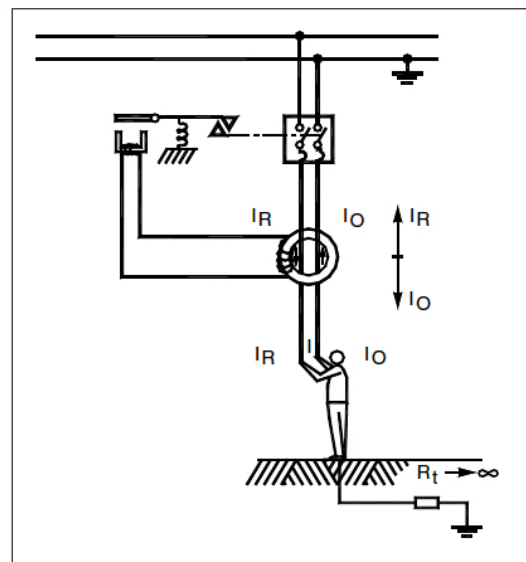

Fig. 4

## Interruptores diferenciales / RCCB's Referencia / Reference: OPR

### Clases de disparo

#### Clase AC

Los interruptores diferenciales de la Clase AC aseguran la desconexión ante una corriente diferencial alterna senoidal, aplicada bruscamente o de valor creciente.

Residual current	Tripping time
$0.5 \times I_{\Delta n}$	$t = \infty$
$1 \times I_{\Delta n}$	$t < 300 \text{ ms}$
$2 \times I_{\Delta n}$	$t < 150 \text{ ms}$
$5 \times I_{\Delta n}$	$t \leq 40 \text{ ms}$

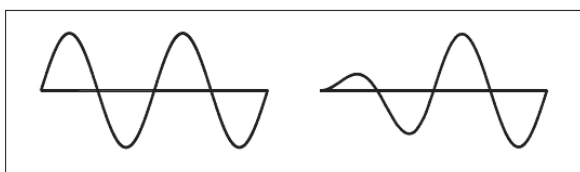

#### Clase A

Los interruptores diferenciales de la Clase A aseguran la desconexión ante corrientes diferenciales alternas o continuas pulsantes, aplicadas bruscamente o de valor creciente.

La presencia de semiconductores (diodos, tiristores, etc.) cada vez más frecuente en los receptores, puede ser la fuente de corrientes de fuga continuas pulsantes.

Tripping curve type A

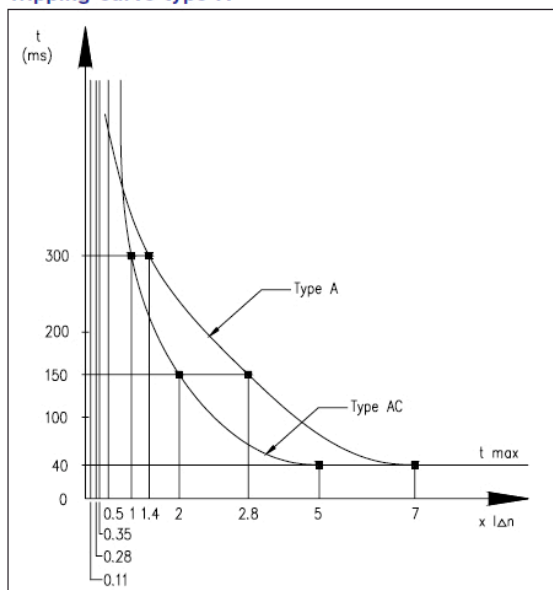

### Tripping classes

#### Type AC

RCCBs are designed to clear sinusoidal residual current which occur suddenly or slowly rise in magnitude.

Tripping curve type AC

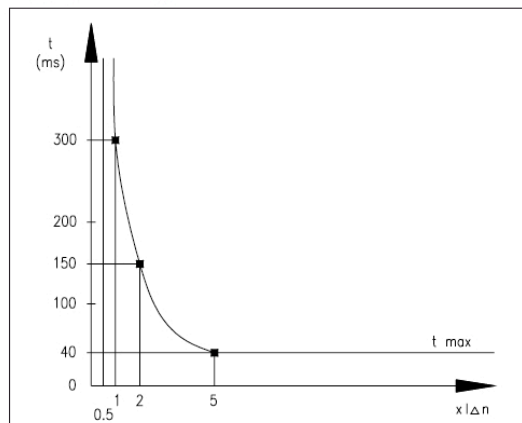

#### Type A

The Type A RCCBs will operate on sinusoidal residual currents and also with residual pulsating direct currents which occur suddenly or slowly increase in magnitude.

Certain devices, during faults, can be the source of non-sinusoidal leakage currents with DC components: diodes, thyristors, etc.

Residual current	Tripping time
<b>Sinusoidal residual current</b>	
$0.5 \times I_{\Delta n}$	$t = \infty$
$1 \times I_{\Delta n}$	$t < 300 \text{ ms}$
$2 \times I_{\Delta n}$	$t < 150 \text{ ms}$
$5 \times I_{\Delta n}$	$t \leq 40 \text{ ms}$

#### Residual pulsating direct current

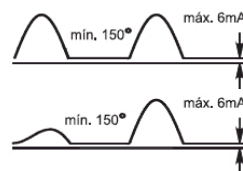

at point on wave 0°

$0.35 \times I_{\Delta n}$	$t = \infty$
$1.4 \times I_{\Delta n}$	$t < 300 \text{ ms}$
$2.8 \times I_{\Delta n}$	$t < 150 \text{ ms}$
$7 \times I_{\Delta n}$	$t \leq 40 \text{ ms}$



at point on wave 90°

$0.25 \times I_{\Delta n}$	$t = \infty$
$1.4 \times I_{\Delta n}$	$t < 300 \text{ ms}$
$2.8 \times I_{\Delta n}$	$t < 150 \text{ ms}$
$7 \times I_{\Delta n}$	$t \leq 40 \text{ ms}$



at point on wave 135°

$0.11 \times I_{\Delta n}$	$t = \infty$
$1.4 \times I_{\Delta n}$	$t < 300 \text{ ms}$
$2.8 \times I_{\Delta n}$	$t < 150 \text{ ms}$
$7 \times I_{\Delta n}$	$t \leq 40 \text{ ms}$

Interruptores automáticos magnetotérmicos / MCB's

OP

Capacidad de Corte Short circuit capacity	
E	3kA
F	6kA
S	6kA
T	10kA
K	15kA

Polos Poles	
1	1P
1N	1P+N
2	2P
3	3P
3N	3P+N
4	4

Corriente Current (in)
1A
2A
3A
4A
6A
10A
16A
20A
25A
32A
40A
50A
63A

Curva Curve	
B	Curva B / B Curve
C	Curva C / C Curve
D	Curva D / D Curve

OPS - Interruptores automáticos magnetotérmicos / MCB's (6kA, 1-63A)

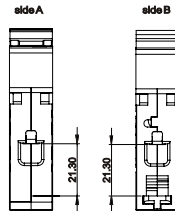
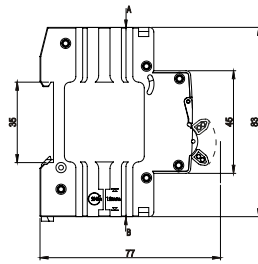
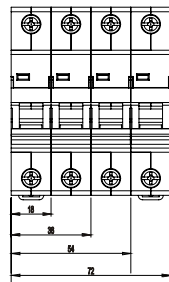

Corriente Current (in)
1A
2A
3A
4A
6A
10A
16A
20A
25A
32A
40A
50A
63A

Referencia Reference
OPS 01 Δ
OPS 02 Δ
OPS 03 Δ
OPS 04 Δ
OPS 06 Δ
OPS 10 Δ
OPS 16 Δ
OPS 20 Δ
OPS 25 Δ
OPS 32 Δ
OPS 40 Δ
OPS 50 Δ
OPS 63 Δ

Polos Poles
1
1N
2
3
3N
4

Curva / Curve
B
C
D

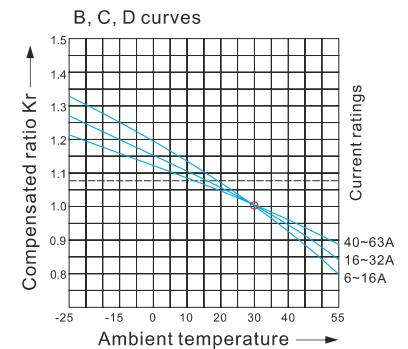
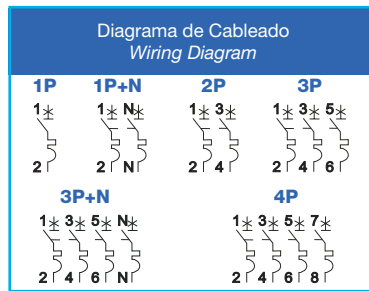
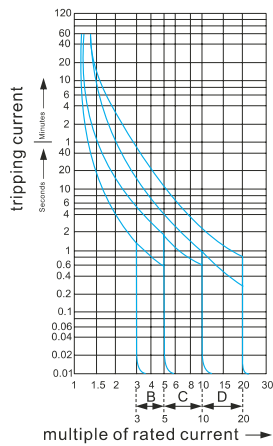

- N° de polos / Number of poles : 1P, 1P+N, 2P, 3P, 3P+N, 4P
- Corriente nominal / Rated current (In,A) : 1A, 2A, 3A, 4A, 6A, 10A, 13A, 16A, 20A, 25A, 32A, 40A, 50A, 63A
- Voltaje nominal / Rated voltage (Ue,V) : 120/240, 230/400, 240/415
- Tensión de aislamiento / Rated insulating voltage (Ui,V) : 500V
- Poder de corte nominal de cortocircuito / Rated short circuit breaking capacity (Icn,A) : 6.000
- Prueba de resistencia dieléctrica / Dielectric strength test voltage for 1 min. (kV) : 2
- Tensión nominal soportada al impulso / Rated impulse withstand voltage (Uimp,kV) : 4

6kA  
4.000 ciclos / cycles  
Max. Conductor flex. 25mm<sup>2</sup>  
Par de torsión / Torque: 2,5Nm (max.)  
Temp. ambiente / Ambient temp: -25°C~+40°C

220/400V  
50/60Hz

IEC EN 60947-2





**OPF - Interruptores automáticos magnetotérmicos estrechos / 1P+N Single Module MCB's (6kA, 1-32A)**

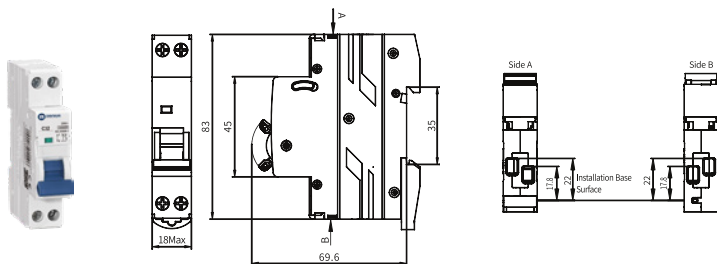

- Tensión de aislamiento / *Rated insulating voltage (U<sub>i</sub>,V)* : 500
- Poder de corte nominal de cortocircuito / *Rated short circuit breaking capacity (I<sub>cn</sub>,A)* : 10.000
- Prueba de resistencia dieléctrica / *Dielectric strength test voltage for 1 min. (kV)* : 2
- Tensión nominal soportada al impulso / *Rated impulse withstand voltage (U<sub>imp</sub>,kV)* : 4

6kA  
4.000 ciclos / *cycles*  
Max. Conductor flex. 16mm<sup>2</sup>  
Par de torsión / Torque: 2Nm (max.)  
Temp. ambiente / *Ambient temp*: -25°C~+40°C

Corriente Current (in)	Referencia Reference
1A	OPF ⊙ 01 ▲
2A	OPF ⊙ 02 ▲
3A	OPF ⊙ 03 ▲
4A	OPF ⊙ 04 ▲
6A	OPF ⊙ 06 ▲
10A	OPF ⊙ 10 ▲
16A	OPF ⊙ 16 ▲
20A	OPF ⊙ 20 ▲
25A	OPF ⊙ 25 ▲
32A	OPF ⊙ 32 ▲

⊙	Polos / Poles
1N	1PN

▲	Curva / Curve
C	Curva C / C Curve

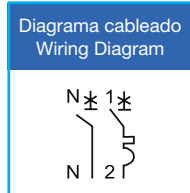

230V  
50/60Hz

CE CB IEC EN 60947-2

**OPT - Interruptores automáticos magnetotérmicos / MCB's (10kA, 1-63A)**

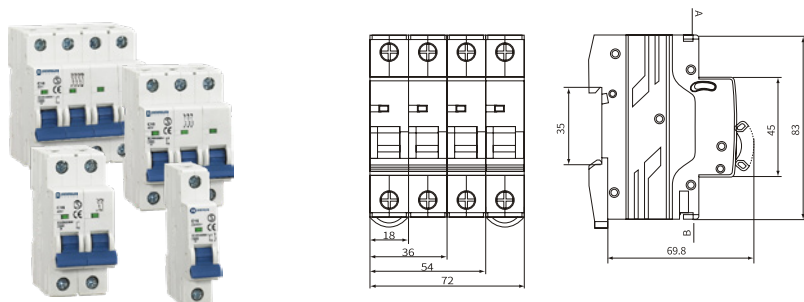

- Tensión de aislamiento / *Rated insulating voltage (U<sub>i</sub>,V)* : 500V
- Poder de corte nominal de cortocircuito / *Rated short circuit breaking capacity (I<sub>cn</sub>,A)* : 10.000
- Prueba de resistencia dieléctrica / *Dielectric strength test voltage for 1 min. (kV)* : 2
- Tensión nominal soportada al impulso / *Rated impulse withstand voltage (U<sub>imp</sub>,kV)* : 4

10kA  
4.000 ciclos / *cycles*  
Max. Conductor flex. 25mm<sup>2</sup>  
Par de torsión / Torque: 2,5Nm (max.)  
Temp. ambiente / *Ambient temp*: -25°C~+40°C

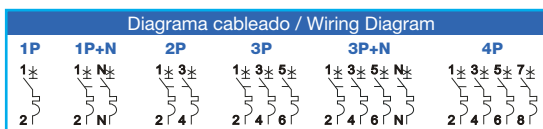

Corriente Current (in)	Referencia Reference
1A	OPT ⊙ 01 ▲
2A	OPT ⊙ 02 ▲
3A	OPT ⊙ 03 ▲
4A	OPT ⊙ 04 ▲
6A	OPT ⊙ 06 ▲
10A	OPT ⊙ 10 ▲
16A	OPT ⊙ 16 ▲
20A	OPT ⊙ 20 ▲
25A	OPT ⊙ 25 ▲
32A	OPT ⊙ 32 ▲
40A	OPT ⊙ 40 ▲
50A	OPT ⊙ 50 ▲
63A	OPT ⊙ 63 ▲

⊙	Polos / Poles
1	1P
1N	1PN
2	2P
3	3P
3N	3PN
4	4

▲	Curva / Curve
B	Curva B / B Curve
C	Curva C / C Curve
D	Curva D / D Curve

230/400V  
50/60Hz

CE CB IEC EN 60947-2

**OPT - Interruptores automáticos magnetotérmicos / MCB's (10kA, 80-125A)**

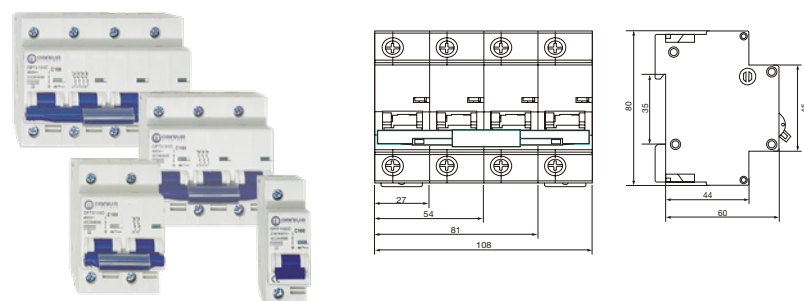

- Tensión de aislamiento / *Rated insulating voltage (U<sub>i</sub>,V)* : 690
- Poder de corte nominal de cortocircuito / *Rated short circuit breaking capacity (I<sub>cn</sub>,A)* : 10.000
- Poder de corte en servicio / *Rated service s-circuit breaking capacity (I<sub>cs</sub>,A)* : 7500
- Prueba de resistencia dieléctrica / *Dielectric strength test voltage for 1 min. (kV)* : 2
- Tensión nominal soportada al impulso / *Rated impulse withstand voltage (U<sub>imp</sub>,kV)* : 6

10kA  
1.500 (I<sub>n</sub>=80, 100A), 1.000 (I<sub>n</sub>=125A) / *cycles*  
Max. Conductor flex. 35mm<sup>2</sup>  
Par de torsión / Torque: 3,5Nm (max.)  
Temp. ambiente / *Ambient temp*: -25°C~+40°C

Corriente Current (in)	Referencia Reference
80A	OPT ⊙ 080 ▲
100A	OPT ⊙ 100 ▲
125A	OPT ⊙ 125 ▲

⊙	Polos / Poles
1	1P
2	2P
3	3P
4	4P

▲	Curva / Curve
B	Curva B / B Curve
C	Curva C / C Curve
D	Curva D / D Curve

230/400V  
50/60Hz

CE CB IEC EN 60947-2

**OPK - Interruptores automáticos magnetotérmicos / MCB's (15kA, 20-125A)**

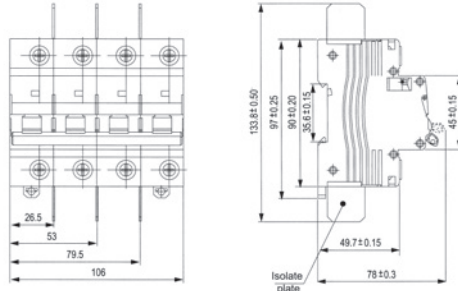

Referencia Reference	Corriente Current (in)
OPK ⊙ 20 ▲	20A
OPK ⊙ 25 ▲	25A
OPK ⊙ 32 ▲	32A
OPK ⊙ 40 ▲	40A
OPK ⊙ 50 ▲	50A
OPK ⊙ 63 ▲	63A
OPK ⊙ 80 ▲	80A
OPK ⊙ 100 ▲	100A
OPK ⊙ 125 ▲	125A

⊙	Polos / Poles
1	1P
1N	1PN
2	2P
3	3P
3N	3PN
4	4

▲	Curva / Curve
C	Curva C / C Curve
D	Curva D / D Curve

15kA  
Resistencia electromecánica / *Electromechanical endurance*  
In ≤ 100 = 10.000 ciclos / *cycles*  
In ≤ 125 = 8.000 ciclos / *cycles*  
Max. Conductor flex. 35mm<sup>2</sup> Max. Conductor rig. 50mm<sup>2</sup>

220/400V  
50/60Hz

IEC EN 60947-2

**OPT - Interruptores automáticos magnetotérmicos / MCB's (DC, 10kA, 10-63A)**

*Aplicación y funciones / Application and functions*

El disyuntor en miniatura fotovoltaico OPT(DC) corta automáticamente el circuito cuando se produce una sobrecarga o cortocircuito. Éste dispositivo proporciona funciones de conmutación, aislamiento y control. Adecuado para su uso en la generación de energía fotovoltaica, sistema de distribución, combinador fotovoltaico y otros equipos eléctricos de corriente directa.

*The OPT(DC) photovoltaic miniature circuit breaker automatically cuts off the circuit when an overload or short circuit occurs. This device provides switching, isolation and control functions. Suitable for use in photovoltaic power generation, distribution system, photovoltaic combiner and other direct current electrical equipment.*



DC

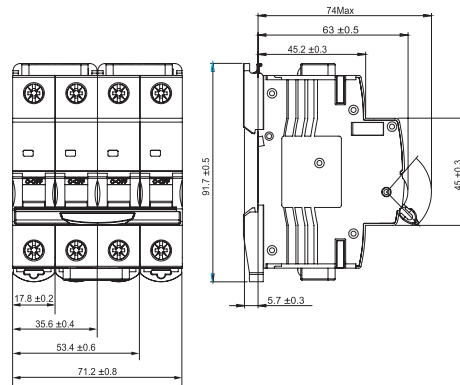

Referencia Reference	Corriente Current (in)
OPT ⊙ 10 ▲	10A
OPT ⊙ 16 ▲	16A
OPT ⊙ 20 ▲	20A
OPT ⊙ 25 ▲	25A
OPT ⊙ 32 ▲	32A
OPT ⊙ 40 ▲	40A
OPT ⊙ 50 ▲	50A
OPT ⊙ 63 ▲	63A

⊙	Polos / Poles
1	1P
2	2P
3	3P
4	4P

▲	Curva / Curve
B-DC	Curva B / B Curve (VDC)
C-DC	Curva C / C Curve (VDC)

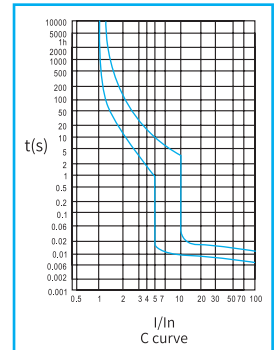
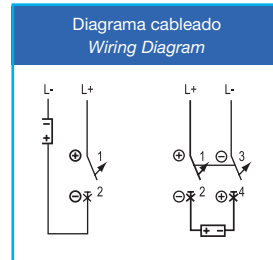

- N° de polos / *Number of poles* : 1P, 2P, 3P, 4P
- Corriente nominal / *Rated current (In,A)* : 10A, 16A, 20A, 25A, 32A, 40A, 50A, 63A
- Voltaje nominal / *Rated voltage (V)* : 1P: 250 2P:500V 3P:750V 4P:1000V
- Poder de corte nominal de cortocircuito / *Rated short circuit breaking capacity (Icn,A)* : 10.000
- Ciclos de resistencia mecánica / *Mechanical endurance cycles* : 10.000
- Tensión nominal soportada al impulso / *Rated impulse withstand voltage (Uimp,kV)* : 6,2

10kA  
10.000 ciclos / *cycles*  
Max. Conductor flex. 35mm<sup>2</sup>  
Par de torsión / *Torque*: 3,5Nm (max.)  
Temp. ambiente / *Ambient temp*: -30°C~+70°C

250-1000V  
50/60Hz

IEC EN 60947-2

**OPA - Accesorios para magnetotérmicos OPS / MCB accessories for OPS breakers**

*Aplicación / Application*

Utilizar con magnetotérmicos OPS para señalización a distancia /  
Use with MCB's type OPS to control remote signalling devices



*Esquemas de combinación / Combination schemes*

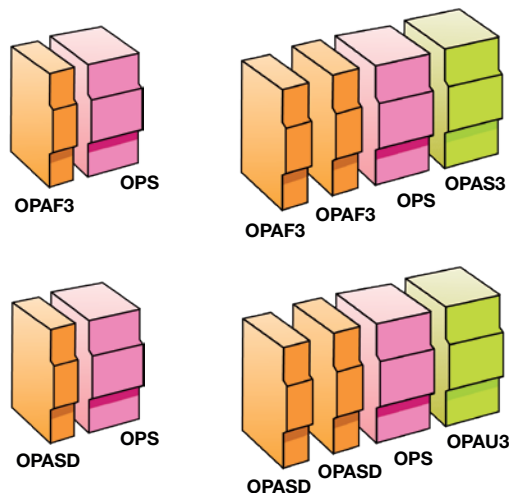

**OPA - Accesorios para magnetotérmicos / MCB's accessories**



<b>OPAF3</b> 	<b>Contacto auxiliar</b> <i>Auxiliar contact</i>	<ul style="list-style-type: none"> <li>&gt; 5.000 ciclos / <i>cycles</i></li> <li>2.000 V/min (Res. dieléctrica / <i>Dielectric res.</i>)</li> </ul>
	<ul style="list-style-type: none"> <li>• AC Un=400V In=3A Un=230V In=6A</li> <li>• DC Un=125V In=1A Un=48V In=2A Un=24V In=6A</li> </ul>	



<b>OPAST</b> 	<b>Bobina de disparo</b> <i>Shunt tripper</i>	<ul style="list-style-type: none"> <li>• Grado de protección / <i>Protection degree</i>: IP20</li> <li>• Temperatura ambiente / <i>Ambient temperature</i>, °C: -5-+40</li> <li>&gt; 4.000 ciclos / <i>cycles</i></li> <li>2.000 V/min (Res. dieléctrica / <i>Dielectric res.</i>)</li> </ul>
	<ul style="list-style-type: none"> <li>• AC Us=230 / 400V Ui=500V IEC 60947-5-1</li> </ul>	



<b>OPASD</b> 	<b>Contacto alarma</b> <i>Alarm switch</i>	<ul style="list-style-type: none"> <li>• Resistencia dieléctrica / <i>Dielectric strength</i>: 2000V/min</li> <li>• Resistencia electro-mecánica / <i>Electro mechanical endurance</i>: ≥4000 cycles</li> </ul>
	<ul style="list-style-type: none"> <li>• AC Us=400V In=3A Un=230V In=6A Un=125V In=9A 0/0</li> </ul>	



<b>OPAU3</b> 	<b>Bobina sobretensión /subtensión</b> <i>Over/Under-voltage tripper</i>	<ul style="list-style-type: none"> <li>• Tensión de aislamiento (Ui) / <i>Rated insulating voltage (Ui)</i>: 500V</li> <li>• Tensión nominal (Us) / <i>Rated power voltage (Us)</i>: AC 400V, 230V, 125V</li> <li>• Rango tensión de funcionamiento / <i>Voltage operating range</i>: 70-100% Us</li> <li>• Tensión nominal (Ue) / <i>Rated voltage (Ue)</i>: AC 230V</li> <li>• Rango disparo de sobretensión / <i>Over voltage tripping range</i>: 280V ± 5%</li> <li>• Rango disparo de subtensión / <i>Under voltage tripping range</i>: 170V ± 5%</li> <li>• Resistencia electro-mecánica / <i>Electro mechanical endurance</i>: ≥4000 cycles</li> </ul>
	<ul style="list-style-type: none"> <li>• AC 3A / 400V 6A / 230V 9A / 125V</li> </ul>	

**OPAFDD - ARC Detector de arcos eléctricos / ARC Fault Detection Device (AFDD)**

*Aplicación / Application*

Detecta eficazmente los arcos eléctricos, responsables del peligro de incendio, desconecta el circuito afectado y ofrece una protección completa en cualquier tipo de edificio.

*The product, effectively detects electric arcs, that are responsible for fire hazard, disconnects the affected circuit and offers complete protection in any type of building.*

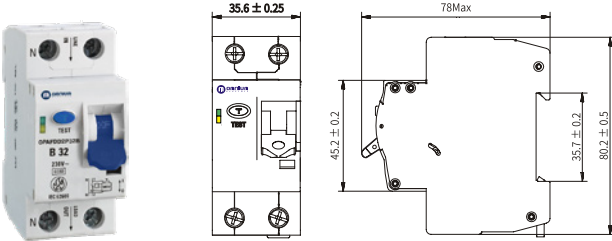

Referencia Reference	Corriente Current (in)	Polos / Poles 1N
OPAFDD 06	6A	1P+N
OPAFDD 10	10A	
OPAFDD 16	16A	
OPAFDD 20	20A	
OPAFDD 25	25A	
OPAFDD 32	32A	

Curva / Curve
C
D

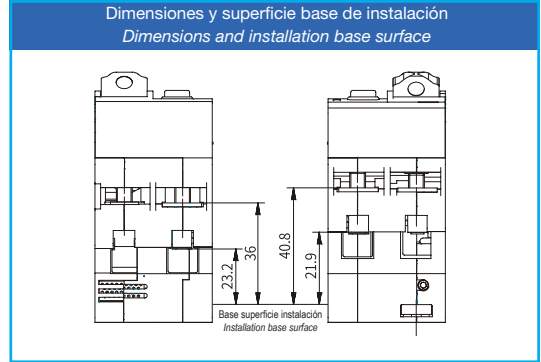
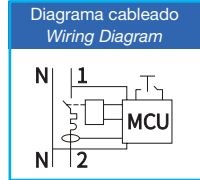

- Tensión de aislamiento / *Rated insulating voltage (Ui,V)* : 500V
- Capacidad de cierre y apertura / *Rated making and breaking capacity (Icn,A)* : 1.000
- Resistencia al impulso de sobretensión / *Rated impulse withstand voltage (Uimp,kV)* : 4
- Prueba de resistencia dieléctrica / *Dielectric strength test voltage for 1 min. (kV)* : 2

**Operación de leds, prueba e identificación de fallas de arco  
LED for operation, test and arc fault identification**

- LED verde ENCENDIDO (parpadea con intervalo de tiempo de 0,6 s) y LED amarillo APAGADO, modo de funcionamiento normal  
*Green LED ON (flashes with time interval 0,6s) and yellow LED OFF, normal operation mode.*
- El LED amarillo parpadea una vez, y luego ambos LEDs se apagan cuando se presiona el botón de prueba, AFDD funciona correctamente  
*Yellow LED flashes for one time, and then both LEDs turn off when test button is pressed, AFDD functions correctly.*
- LED verde ENCENDIDO (parpadea con un intervalo de tiempo de 0,6 s), el LED amarillo se apaga después de parpadear de 5 a 6 veces cuando la palanca se vuelve a cerrar y la carga se desconecta, último disparo por falla de arco  
*Green LED ON (flashes with time interval 0,6s), Yellow LED turns off after flashes for 5-6 times when toggle being reclosed and load being disconnected, last tripping by arc fault.*
- El LED amarillo parpadea una vez, el AFDD se dispara y ambos LEDs se apagan después de operar la carga, se confirma la falla del arco  
*Yellow LED flashes for one time, AFDD trips and both LEDs turn off after load being operated, arc fault confirmed.*

1 Polo + neutro / 1 Pole + neutral  
6kA  
4.000 ciclos / cycles  
Max. Conductor. 25mm<sup>2</sup>  
Par de torsión / Torque: 2.5Nm (max.)  
Temp. ambiente / Ambient temp: -25°C~+40°C



**OPW - Diferencial incorporado / RCBO's / (6kA, 6-40A)**

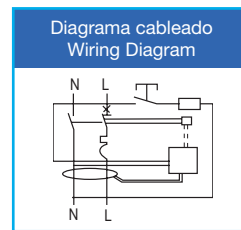
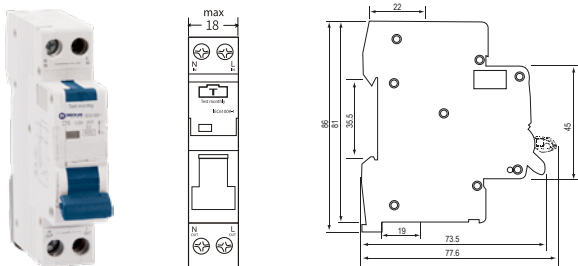

Referencia Reference	Corriente Current (in)
OPW1N 06	6A
OPW1N 10	10A
OPW1N 16	16A
OPW1N 20	20A
OPW1N 25	25A
OPW1N 32	32A
OPW1N 40	40A

Curva / Curve
B
C

Sensibilidad / Sensitivity
030

- Tensión de aislamiento / *Rated insulating voltage (Ui,V)* : 500V
- Resistencia al impulso de sobretensión / *Rated impulse withstand voltage (Uimp,kV)* : 4
- Prueba de resistencia dieléctrica / *Dielectric strength test voltage for 1 min. (kV)* : 2

1 Polo + neutro / 1 Pole + neutral  
6.000 ciclos / cycles  
Max. Conductor. 16mm<sup>2</sup>  
Par de torsión / Torque: 1.2Nm (max.)  
Temp. ambiente / Ambient temp: -5°C~+55°C  
Clase / Class: A





**OPR - Interruptores diferenciales / RCCB's (10kA, 25-63A)**



Referencia Reference
OPR 25
OPR 40
OPR 63

Corriente Current (in)
25A
40A
63A

Polos / Poles
1N
3N

Clase / Class
A

Sensibilidad / Sensitivity
030
100
300

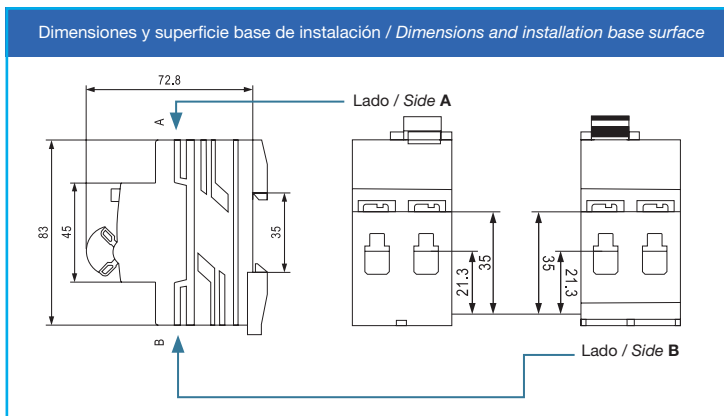
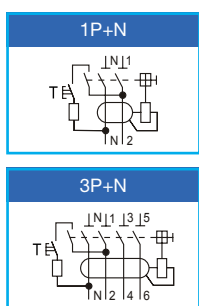
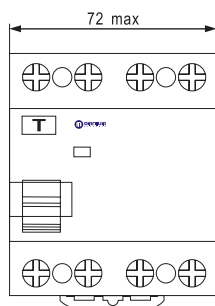

- Tensión de aislamiento (Ui) / Rated insulating voltage (Ui) : 500V
- Rated residual current (mA) / Corriente residual (mA) : 30 / 100 / 300
- Corriente condicional nominal de cortocircuito (A) / Rated conditional short circuit current (A) : 10.000
- Corriente residual nominal de cortocircuito (A) / Rated conditional residual short circuit current (A) : 10.000
- Capacidad de cierre y apertura (A) / Rated making and breaking capacity (A) : 1.000
- Capacidad residual de cierre y apertura (A) / Rated residual making and breaking capacity (A) : 1.000
- Resistencia al impulso de sobretensión (kV) / Rated impulse withstand voltage (kV) : 4
- Prueba de resistencia dieléctrica (kV) / Dielectric strength test voltage for 1 min. (kV) : 2

10kA  
4.000 ciclos / cycles  
Max. Conductor. 25mm<sup>2</sup>  
Par de torsión / Torque: 2.5Nm (max.)  
Temp. ambiente / Ambient temp: -25°C~+40°C

230/400V  
50/60Hz



IEC EN 61008-1

**OPD - Seccionadores modulares / Switch disconnectors / 16-125A**

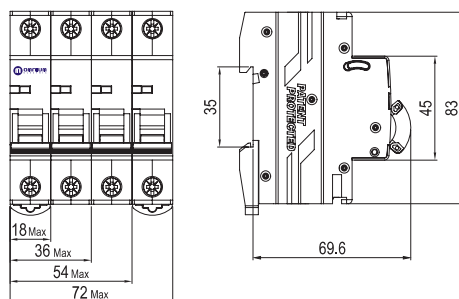

Corriente Current (in)
16A
25A
32A
40A
63A
80A
100A
125A

Referencia Reference
OPD 016
OPD 025
OPD 032
OPD 040
OPD 063
OPD 080
OPD 100
OPD 125

Polos / Poles
1
2
3
4

1P: 230V~  
2P, 3P, 4P: 415V~  
50/60Hz



IEC 60947-3

OPQ - Interruptores diferenciales rearmables / Auto reclosing RCCB's (10kA, 40-63A)

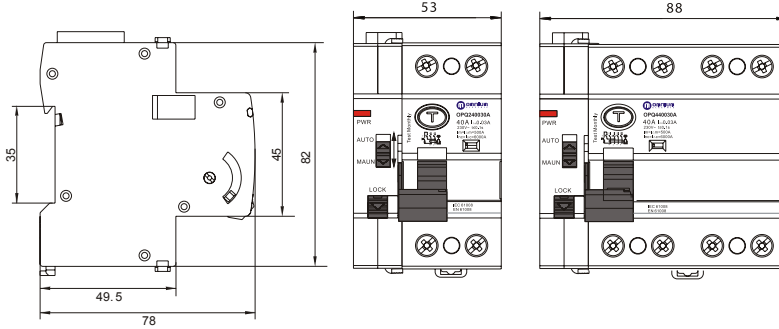

Referencia Reference	Corriente Current (in)
OPQ 40	40A
OPQ 63	63A

Polos / Poles
2P
4P

Sensibilidad / Sensitivity
30mA
300mA

Clase / Class
A
AC

OPQ - Funcionalidades y características / Functionality and characteristics

Funciones  
Functions

**Tr: 2s. Retardo de potencia Power delay**

**Reestablecer tiempos de cierre Reset closing times**

Combinar con Diferencial  
Combine with RCCB

Combinar con Térmico  
Combine with MCB

Bloqueo de cierre  
Closing lock

Instalación de Accesorios  
Accessory Installation

- Modo de control / Control mode : Rearmable / Auto-reclosing
- Terminales de alimentación / Supply terminals : A1 - A2
- Indicador de alimentación / Supply indicator : LED (rojo/red)
- Potencia de entrada / Power input : DC max. 1W (reposo/standby) / max. 20W (acción/action)
- Tolerancia de tensión de alimentación / Supply voltage tolerance : + / - 10%
- Tiempo de respuesta / Reaction time : <= 1s. (Tiempo rearme / Auto reclosing time: 3s.)
- Intervalos de rearme / Auto reclosing intervals: 10s. - 60s. - 300s.

10kA  
4.000 ciclos / cycles  
Max. Conductor. 25mm<sup>2</sup>

220V  
50/60Hz



UNE EN 63024



## OPRB - Interruptores diferenciales TIPO B / TYPE B Residual current breakers (10kA, 16-63A)

### Aplicación / Application

Los interruptores diferenciales OPR de tipo B, integrados con módulos de detección dual, detectan eficazmente cualquier tipo de corrientes de falla de tierra y cortan automáticamente el circuito. El dispositivo es principalmente aplicable a las siguientes instalaciones.

*The B type RCCBs OPR, integrated with dual detection modules, effectively detect any type of earth fault currents and automatically cut off circuit. The device is mainly applicable to following installations.*

- Dispositivos con inversores trifásicos AC / DC como cargadores de baterías para vehículos eléctricos, máquinas herramienta, ascensor para edificios muy altos, tracción ferroviaria, soldador eléctrico.

*Devices with three-phase AC/DC inverters such as electric vehicle battery chargers, machine tools, elevator for very high buildings, railway traction, electric welder.*

- Dispositivos con convertidores de frecuencia como sistemas de bombeo, sistema de tratamiento de aire y sistema de procesamiento industrial.

*Devices with frequency inverters such as pumping systems, air treatment system and industrial processing system.*

- Lugares equipados con UPS trifásicos como hospitales, instalaciones de telecomunicaciones, centros de datos y ordenadores, instalaciones de seguridad, etc.

*Places equipped with three-phase UPS such as hospitals, telecommunication facilities, data and computer centers, security installations etc.*

- Equipo electromédico alimentado por un inversor AC / DC empotrado.

*Electro-medical equipment powered by an imbedded AC/DC inverter.*

- Sistemas fotovoltaicos en caso de que se instalen inversores sin separación entre el lado de CA y CC.

*Photovoltaic systems in case inverters are installed with no separation between AC and DC side.*

Este RCCB tipo B proporciona la máxima protección contra las siguientes corrientes de falla a tierra / *This B type RCCBs provides maximum protection against following earth fault currents:*

- Corriente de falla a tierra de CC pulsante / *Pulsating DC earth fault current.*
- Corrientes de falla a tierra CA hasta 1000Hz / *AC earth fault currents up to 1000Hz.*
- Corriente continua de falla a tierra de CC. / *Smooth DC earth fault current.*



Referencia Reference
OPRB 16
OPRB 25
OPRB 32
OPRB 40
OPRB 63

Corriente Current (in)
16A
25A
32A
40A
63A

Polos / Poles
2 1P+N
4 3P+N

Sensibilidad / Sensitivity
030 30mA
300 300mA

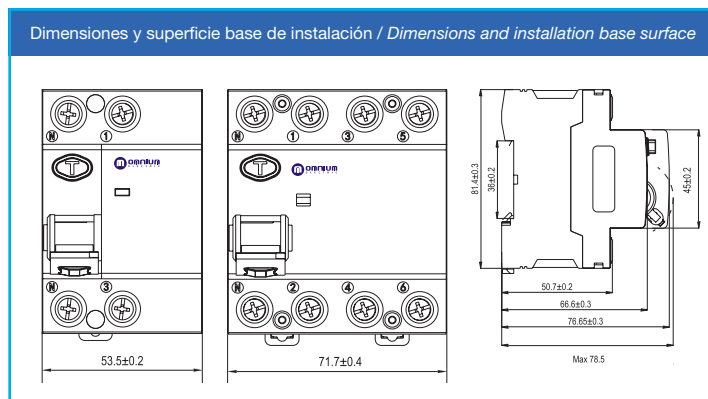
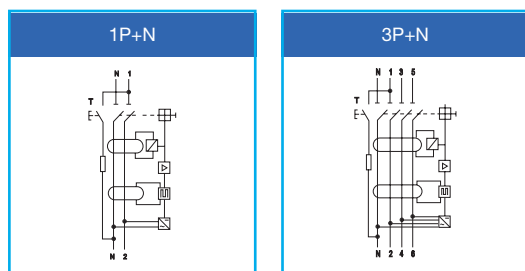

- Tensión de aislamiento (Ui) / *Rated insulating voltage (Ui)* : 500V
- Rated residual current (mA) / *Corriente residual (mA)* : 30 / 300
- Corriente condicional nominal de cortocircuito (A) / *Rated conditional short circuit current (A)* : 10.000
- Corriente residual nominal de cortocircuito (A) / *Rated conditional residual short circuit current (A)* : 10.000
- Capacidad de cierre y apertura (A) / *Rated making and breaking capacity (A)* : 1.000
- Capacidad residual de cierre y apertura (A) / *Rated residual making and breaking capacity (A)* : 1.000
- Resistencia al impulso de sobretensión (kV) / *Rated impulse withstand voltage (kV)* : 4
- Prueba de resistencia dieléctrica (kV) / *Dielectric strength test voltage for 1 min. (kV)* : 2

10kA  
4.000 ciclos / *cycles*  
Max. Conductor. 25mm<sup>2</sup>  
Par de torsión / *Torque*: 2.5Nm (max.)  
Temp. ambiente / *Ambient temp*: -25°C~+40°C

230/400V  
50/60Hz

IEC 61008-1  
IEC 62423

**OPATS - Interruptor de transferencia automática / Automatic transfer switch**

*Aplicación / Application*

El Interruptor de transferencia automática (ATS) de clase CB, equipado con un dispositivo de conmutación (MCB) ofrece protección contra sobrecorriente y cortocircuito, aplicable al sistema de suministro de energía de emergencia de voltaje nominal 230 / 400V AC y corriente nominal de hasta 63A.

*The Automatic Transfer Switch (ATS) of CB class, equipped with switching device (MCB) offering protection against both over-current and short circuit, is applicable to emergency power supply system of rated voltage 230/400V AC and rated current up to 63A.*

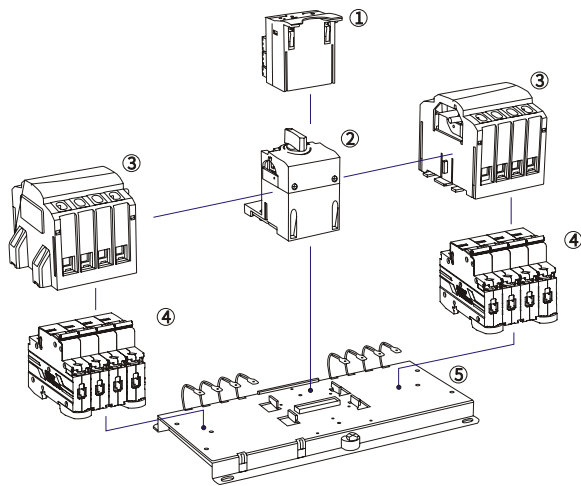
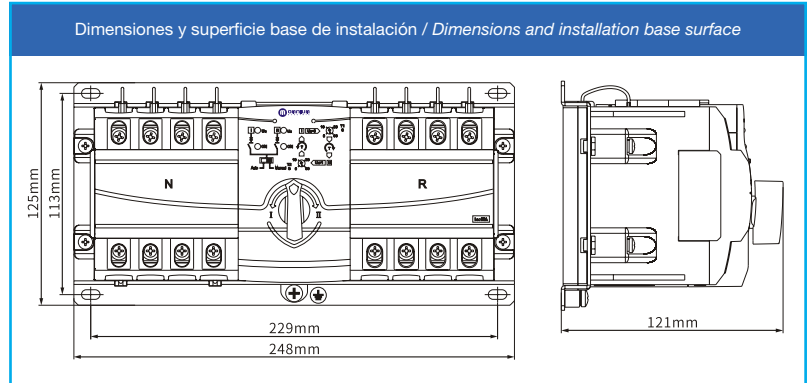

**Descripción / Description**

1. Controlador / Controller
2. Dispositivo motorizado con enclavamiento mecánico / Mechanical interlocked motorized device
3. Cubierta de seguridad / Safety cover
4. Dispositivo de conmutación / Switching device (MCB)
5. Placa de montaje / Mounting plate

**Ventajas / Advantages**

- Diseño modular con dispositivo de conmutación separado (MCB), panel de control, dispositivo motorizado.  
*Modular design with separate switching device (MCB), controller panel, motorized device.*
- El tamaño compacto ahorra espacio de instalación.  
*Compact size saves installation space.*
- Alta capacidad de corte de cortocircuito hasta 10kA.  
*High short circuit breaking capacity up to 10kA.*
- Múltiples funciones, incluido el arranque automático del generador, control de enlace de incendios y retardo de encendido.  
*Multiple functions including generator auto-start, fire linkage control and ON delay.*
- Múltiples modos de transferencia que incluyen transferencia automática + restauración automática, restauración manual de transferencia automática, transferencia entre la red eléctrica y el generador.  
*Multiple transfer modes including auto transfer + auto restore, auto transfer manual restore, transfer between power grid and generator.*

**Diagrama de panel de control / Control panel diagram**

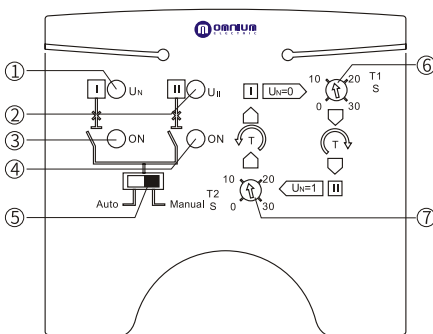

- Descripción / Description**
1. Indicador de fuente de alimentación principal / Main power supply indicator
  2. Indicador de suministro de energía de respaldo / Backup power supply indicator
  3. Indicador de encendido de la fuente de alimentación principal. El indicador parpadea durante el tiempo de espera de restauración. / Main power supply ON indicator. The indicator flashes during restore time delay
  4. Indicador de suministro de energía de respaldo. El indicador parpadea durante la demora del tiempo de transferencia. / Backup power supply indicator. The indicator flashes during transfer time delay
  5. Selector de modo de operación automática o manual / Auto or manual operation mode selector
  6. Configuración de retardo de tiempo para la transferencia a la fuente de alimentación de respaldo / Time delay setting for transfer to backup power supply
  7. Ajuste del tiempo de reposición de la alimentación principal / Time delay setting for restore to main power supply



CARACTERÍSTICAS TÉCNICAS / TECHNICAL CHARACTERISTICS

GENERAL	
Clase de contaminación / Pollution class	3
N° de polos / N° of poles	4
Voltaje nominal de operación / Rated operation voltage (Ue,V)	400V
Voltaje nominal de aislamiento / Rated insulation voltage (Ui,V)	440V
Voltaje nominal soportado por impulso / Rated impulse withstand voltage (Uimp,kV)	6kV
Capacidad nominal de corte en cortocircuito / Rated short circuit breaking capacity	6, 10kA
Tipo de controlador / Controller type	D
Dispositivo de conmutación / Switching device (MCB)	OPS
Corriente nominal / Rated current (In, A)	1-63A
Categoría de uso / utilization category	AC-33iB
Temperatura ambiente / Ambient temperature (°C)	-5 ~+40
CONTROLADOR / CONTROLLER	
Voltaje de alimentación / Supply voltage	AC 230V, 50/60Hz
Modos de operación / Operation modes	Auto y manual
Posición de la manija en operación manual / manual operation handle position	I-O-II
Modo de transferencia / Transfer mode	Transferencia automática + restauración automática, transferencia automática + restauración manual; transferencia automática entre la red eléctrica y el generador / Auto transfer + auto restore, auto transfer + manual restore; auto transfer between power grid and generator.
Control de generador / Generator control	Relé pasivo con contacto seco / Passive relay with dry contact
Control de enlace de incendios / Fire linkage control	Entrada vía contacto seco, señal de retroalimentación vía contacto seco 1NO / Input via dry contact, feedback signal via dry contact 1NO
Bajo monitoreo de voltaje / under voltage monitoring	Disponible / Available
Tiempo de retardo / Time delay	Retardo de transferencia 0-30s ajustable / Transfer delay 0-30 sec adjustable Retardo de restauración 0-30s ajustable / Restore delay 0-30 sec adjustable
Monitoreo de fase / Phase monitoring	A, B, C, N
Montaje / Mounting	Integrado / Integrated

DIAGRAMA DE CABLEADO / WIRING DIAGRAM

ATS

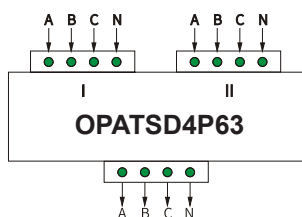

Controlador  
Controller

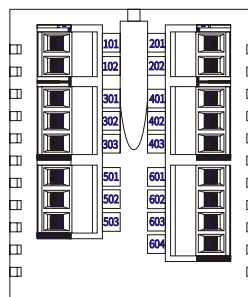

Para ATS equipado con dispositivo de conmutación de 3 polos / For ATS equipped with 3 pole switching device

101, 102 | Cualquiera de las terminales es bueno para la línea neutra de la alimentación principal / Either terminal is good for neutral line of main power supply

201, 202 | Cualquiera de las terminales es bueno para la línea neutra de alimentación de respaldo / Either terminal is good for neutral line of backup power supply

Para indicación de estado de la fuente de alimentación principal / For status indication of main power supply

301 | Línea neutra de la lámpara de señal / Neutral line of signal lamp

302 | Indicación del estado de la fuente de alimentación principal / Main power supply status indication

303 | Indicación de restablecimiento de la alimentación principal / Restore to main power supply indication

Para indicación del estado de la fuente de alimentación de respaldo / For status indication of backup power supply

401 | Línea neutra de la lámpara de señal / Neutral line of signal lamp

402 | Indicación del estado de la fuente de alimentación de respaldo / Backup power supply status indication

403 | Indicación de transferencia a la fuente de alimentación de respaldo / Transfer to backup power supply indication

Para control de generador / For generator control

501 ~ 503 Tres terminales de relé pasivo con contactos secos para la conexión con el controlador del generador y para realizar la función de arranque automático / Three terminals of passive relay with dry contacts for connection with generator controller and to realize the auto-start function

501- Terminal para 1NC / Terminal for 1NC

502- Terminal para 1NO / Terminal for 1NO

503- Terminal común / Common terminal

501 Fuente de alimentación principal encendida, 502-503 cerrada, 501-503 abierta / Main power supply ON, 502-503 closed, 501-503 open

502 Fuente de alimentación principal apagada, falla la fuente de alimentación de respaldo, 501-503 cerrado, 502-503 abierto y el generador se inicia automáticamente, mientras tanto, ATS se transfiere a la fuente de alimentación de respaldo. Una vez que se recupera la fuente de alimentación principal, ATS vuelve a cambiar a la fuente de alimentación principal con un retraso en la restauración, 501-503 se cierra con un retraso de 3 s, 502-503 se abre y el generador se detiene / Main power supply OFF, backup power supply fails, 501-503 closed, 502-503 open and generator automatically starts, ATS meantime transfer to backup power supply. once main power supply recovers, ATS switches back to main power supply with delay in reset, 501-503 closed with delay by 3s, 502-503 open and generator stops

Para control de enlace de incendios / For fire linkage control

601, 602 | Terminales de entrada para control de enlace de incendio, solo aplicable al contacto seco 1NO (se debe conectar un relé de potencia mini al controlador en caso de que la señal de incendio sea activa), cuando el contacto seco 1NO se cierra, el controlador ATS activa el dispositivo de conmutación para cortar su carga y enviar la señal de vuelta al centro de control de incendios a través de los terminales 603-604 / input terminals for fire linkage control, only applicable to 1NO dry contact (a mini-power relay must be connected to the controller in case fire signal is an active one), when 1NO dry contact closes, the ATS controller triggers the switching device to cut off its load and sends back signal to the fire control center via terminals 603-604

603, 604 | Terminales conectados con contacto seco del relé 1NO y utilizados para transmitir la señal de retroalimentación después de la operación de control de enlace de incendio / Terminals connected with dry contact of 1NO relay and used to transmit feedback signal after fire linkage control operation

**OPATS - Interruptor de transferencia automática / Automatic transfer switch**

*Aplicación / Application*

El Interruptor de Transferencia Automática (ATS) de clase PC, equipado con disyuntor de carga de alta capacidad de cierre y corte, es aplicable al sistema de suministro de energía de emergencia de voltaje nominal 400V AC y corriente nominal hasta 630A. El ATS asegura un suministro de energía alternativo confiable en una amplia variedad de instalaciones residenciales, comerciales, industriales y agrícolas.

*The Automatic Transfer Switch (ATS) of PC class, equipped with load breaker of high making and breaking capacity, is applicable to emergency power supply systems of rated voltage 400V AC and rated current up to 630A. The ATS secures reliable alternative power supply in a wide variety of residential, commercial, industrial and agricultural installations.*

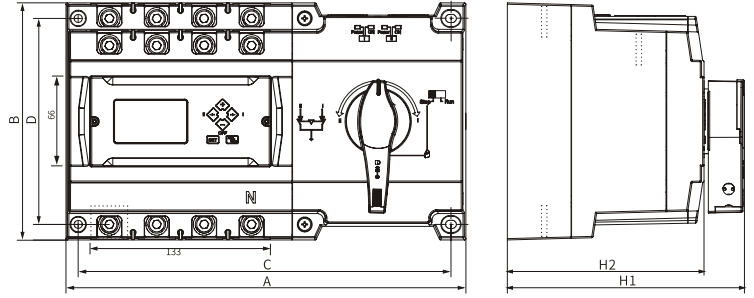
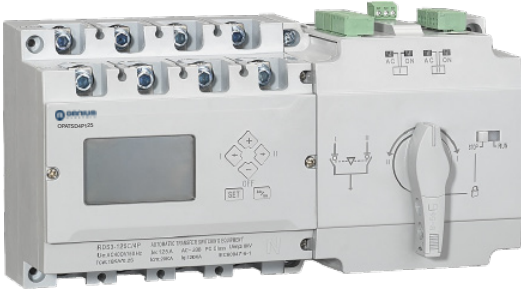

Modelo Model	A	B	C	D	H1	H2
OPATSD4P125	245	130	230	113	122	105
OPATSD4P250	295	175	275	152	175	145
OPATSD4P630	430	272	400	240	228	190

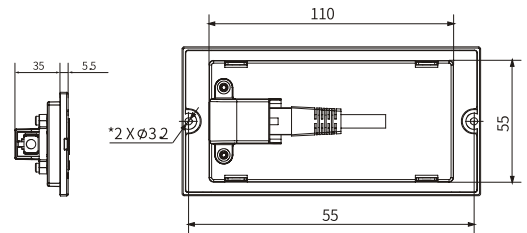
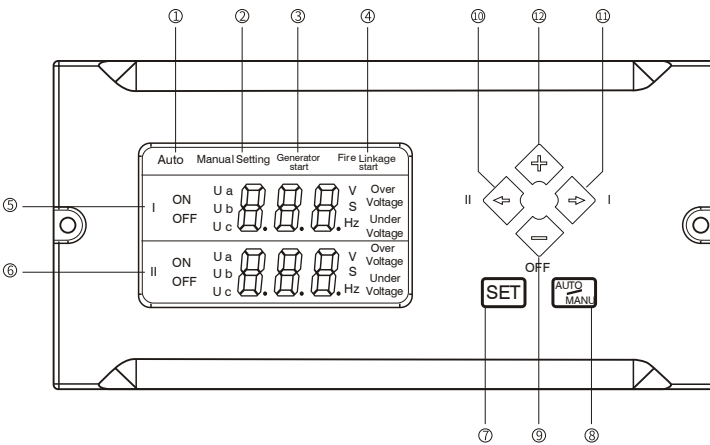

- Indicador de modo de funcionamiento automático/manual / *Auto/manual operation mode indication*
- Indicador de ajuste / *Setting indication*
- Indicador de arranque del generador / *Generator start indication*
- Indicador de activación del control de enlace de incendios / *Fire linkage control actuating indication*
- Parámetros de la fuente de alimentación principal / *Main power supply parameters*
  - Tensión, retardo de transferencia mostrado con ATS en servicio / *Voltage, transfer delay time displayed with ATS at service*
  - Códigos para configurar con ATS iniciado / *Codes for setting with ATS being set*
- Parámetros de la fuente de alimentación de respaldo / *Backup power supply parameters*
  - Tensión, retardo de transferencia mostrado con ATS en servicio / *Voltage, transfer delay time displayed with ATS at service*
  - Parámetros para configurar con ATS iniciado / *Parameters for setting with ATS started*
- Botón "SET" para el menú de configuración / *Button "SET" for setting menu*
- Botón "AUTO/ MANU" de cambio de modos de operación (usado como Guardar y Salir al configurar ATS)  
*Button "AUTO/ MANU" of operation modes change (used as Save and Exit upon setting ATS)*
- Botón "←" para apagar cualquiera de los disyuntores de carga en modo de operación manual (utilizado como valor de parámetro menos al configurar ATS) / *Button "←" for switching off either load breaker under manual operation mode (minus parameter used upon setting ATS)*
- Botón "→" para transferir a la fuente de alimentación principal en el modo de operación manual (se usa como Page Up al configurar ATS) / *Button "→" for transfer to main power supply under manual operation mode (used as Page Up upon setting ATS)*
- Botón "←" para transferir a la fuente de alimentación de respaldo en el modo de operación manual (se usa como Page Down al configurar ATS) / *Button "←" for transfer to backup power supply under manual operation mode (used as Page Down upon setting ATS)*
- Botón "+" para el valor del parámetro más al configurar ATS / *Button "+" for parameter value plus upon setting ATS*

CARACTERÍSTICAS TÉCNICAS / TECHNICAL CHARACTERISTICS

GENERAL

Modelo / Model	OPASTSD4P125	OPASTSD4P250	OPASTSD4P630
Nº de polos / N° of poles	4	4	4
Corriente nominal / Rated current (In,A)	125	250	630
Tensión nominal de aislamiento / Rated insulation voltage (Ui,V)	800	800	800
Tensión nominal soportado por impulso / Rated impulse withstand voltage (Uimp,kV)	8	8	8
Capacidad productiva Icm (valor pico kA) / Making capacity Icm (kA peak value)	20	30	50
Corriente soportada de corta duración / Rate short time withstand current (Icw, kA, rms)	10	10	10
Límite nominal de corriente de cortocircuito / Rated limit short circuit current (Iq, kA)	120	120	120
Tiempo de cambio de contacto / Contact changeover time (S)	1,5	1,8	2
Resistencia electro-mecánica / Electrical mechanical endurance (cycles)	1000	8000	4000

CONTROLADOR / CONTROLLER

Tensión de alimentación / Supply voltage	AC 230V, 50/60Hz
Modos de operación / Operation modes	Auto y manual
Posición de la manija en operación manual / manual operation handle position	I-O-II
Modo de transferencia / Transfer mode	Transferencia automática + restauración automática, transferencia automática + restauración manual; transferencia automática entre la red eléctrica y el generador / Auto transfer + auto restore, auto transfer +manual restore; auto transfer between power grid and generator.
Control de generador / Generator control	Inicio y parado automático / Auto start and auto stop
Control de enlace de incendios / Fire linkage control	Transferencia auto + restauración auto, transferencia auto + restauración manual; transferencia auto entre la red eléctrica y el generador / Auto transfer + auto restore, auto transfer +manual restore; auto transfer between power grid and generator
Rango de ajuste de baja tensión / Under-voltage setting range	150-200V ajustable
Rango de ajuste de sobretensión / Over-voltage setting range	240-290V ajustable
Monitoreo de tensión / Voltage monitoring	Baja tensión, sobre tensión, fallo de fase / Under-voltage, over-voltage, phase failure
Tiempo de retardo / Time delay	Retardo de transferencia / Transfer delay: 0-300 sec (Ajustable / Adjustable) Retardo de restauración / Restore delay: 0-300 sec (Ajustable / Adjustable) Arranque y parada del generador / Generator start & stop: 0-300 sec (Ajustable / Adjustable)

DIAGRAMA DE CABLEADO / WIRING DIAGRAM

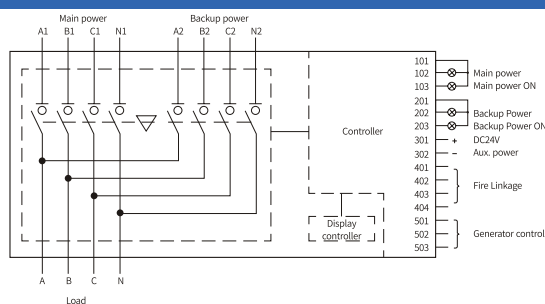

Para indicación del estado de la fuente de alimentación principal / For status indication of main power supply

101	Línea neutra de la lámpara de señal / Neutral line of signal lamp
102	Indicación del estado de la fuente de alimentación principal / Main power supply status indication
103	Indicación de restablecimiento de la alimentación principal / Restore to main power supply indication

Para indicación del estado de la fuente de alimentación de respaldo / For status indication of backup power supply

201	Línea neutra de la lámpara de señal / Neutral line of signal lamp
202	Indicación del estado de la fuente de alimentación principal / Main power supply status indication
203	Indicación de restablecimiento de la alimentación principal / Restore to main power supply indication

Para fuente de alimentación auxiliar CD / For DC auxiliary power supply

301,302	Configuración de retardo de tiempo para la transferencia entre el generador y la red eléctrica. Sin fuente de alimentación auxiliar de CC, no habrá retardo de tiempo para esta transferencia / Time delay setting for transfer between generator and power grid. Without DC auxiliary power supply, there will be no time delay for this transfer
---------	--

Para control de enlace de incendios / For fire linkage control

401,402	Terminales de entrada para control de enlace de incendio, solo aplicable al contacto seco 1NO (se debe conectar un mini relé de potencia al controlador en caso de que la señal de incendio sea activa), cuando el contacto seco 1NO se cierra, el controlador ATS activa el disyuntor para cortar su carga y enviar la señal de vuelta al centro de control de incendios a través de los terminales 403, 404 / Input terminals for fire linkage control, only applicable to 1NO dry contact (a mini-power relay must be connected to the controller in case fire signal is an active one), when 1NO dry contact get closed, the ATS controller triggers the load breaker to cut off its load and send back signal to the fire control center via terminals 403, 404
403,404	Terminales conectados con contacto seco del relé 1NO y utilizados para transmitir la señal de retroalimentación después de la operación de control de enlace de incendio / Terminals connected with dry contact of 1NO relay and used to transmit feedback signal after fire linkage control operation

Para control de generador / For generator control

501, 502, 503	501 ~ 503 Tres terminales de relé pasivo con contactos secos para conectarse con el generador de energía y realizar la función de inicio automático para la transferencia de la red eléctrica al generador en el modo de operación automática / 501~503 Three terminals of passive relay with dry contacts to be connected with power generator and to realize the auto-start function for power grid-generator transfer under auto operation mode 501- terminal para 1NO / 501- terminal for 1NO 502- terminal común / 502- common terminal 503- terminal para 1NC / 503- terminal for 1NC Fuente de alimentación principal encendida, 501-502 cerrada, 502-503 abierta / Main power supply ON, 501-502 closed, 502-503 open Fuente de alimentación principal apagada, falla la fuente de alimentación de respaldo, 502-503 cerrado, 501-502 abierto y el generador se inicia automáticamente, mientras tanto, ATS se transfiere a la fuente de alimentación de respaldo. Una vez que se recupera la fuente de alimentación principal, el ATS vuelve a cambiar a la fuente de alimentación principal con retraso en la restauración, 501-502 se cierra con el retardo de tiempo establecido, 502-503 se abre y el generador se detiene / Main power supply OFF, backup power supply fails, 502-503 closed, 501-502 open and generator automatically starts, ATS meantime transfer to backup power supply. Once main power supply recovers, ATS switches back to main power supply with the delay established, 501-502 closed with set time delay, 502-503 open and generator stops
---------------	--

**OPC - Contactores modulares AC / Modular AC contactors**  
**20A, 32A, 40A, 63A (Polos / Poles: 2P / 3P / 4P)**

**Aplicación**

El Contactor Modular AC (Contactor) ha sido principalmente diseñado para circuitos de 50Hz o 60Hz, con una corriente alterna de 230V. En usos AC-7a, voltaje nominal de hasta 230V, y corriente nominal de hasta 63A. Sirve para el control de circuitos a larga distancia. Este producto es adecuado para aplicaciones domésticas o de baja carga inductiva, así como para el control de carga de electromotores domésticos, o usos similares.

**Application**

The OPC Modular AC Contactor (Contactor for short) is mainly designed for AC 50Hz or 60Hz circuits with 230V rated operating voltage. In AC-7a usage, rated operating voltage up to 230V, rated operating current up to 63A. It functions as long distance breaking and circuit controlling. This product is mainly applied to household appliances or low inductance loading and home electromotor loading control used for similar purpose.

		Tipos de contactor y características / Types of contactor and characteristics								
		1 Polo / 1 Pole			2 Polos / 2 Poles			3 Polos / 3 Poles		
		OPC216*	OPC220*	OPC225*	OPC232*	OPC240*	OPC263*	OPC2100*		
		OPC316*	OPC320*	OPC325*	OPC332*	OPC340*	OPC363*			
		OPC416*	OPC420*	OPC425*	OPC432*	OPC440*	OPC463*	OPC4100*		
Tensión nominal / Rated operating voltage (Ue,V)		250V			400V			400V		
Corriente nominal de operación / Rated operating current (Ie,A)	AC-7a	16	20	25	32	40	63	100		
	AC-7b	6	7	9	12	18	25	--		
Corriente térmica convencional / Conventional thermal current (Ith,A)		25	25	25	63	63	63	100		
Tensión de aislamiento / Rated insulating voltage (Ui,V)		500V								
Tipo de contacto / Contact type	2 Polos / 2 Poles	2NO, 1NO+1NC, 2NC								
	3 Polos / 3 Poles	3NO, 3NC								
	4 Polos / 4 Poles	4NO, 4NC, 2NO+2NC, 3NO+1NC, 1NO+3NC								
Potencia controlada / Controlled power (Kw)	250V (AC-7a)	3,5	4,5	5,5	8	9	14	22		
	400V (AC-7a)	6	7,5	9,5	12	15	24	38		
	250V (AC-7b)	1,4	1,6	2	3	4	5,5	--		
	400V (AC-7b)	2,3	2,7	3,4	4,5	7	9	--		
Tensión de bobina / Coil voltage (Uc,VAC)		24, 110, 230								

OPC - Contactores modulares AC / Modular AC contactors



Referencia Reference	Corriente Current (in)	⊙ Polos / Poles
OPC ⊙ 20	20A	2P
OPC ⊙ 25	25A	3P
OPC ⊙ 32	32A	4P
OPC ⊙ 40	40A	
OPC ⊙ 63	63A	
OPC ⊙100	100A	

Voltaje / Voltage
012 12V
024 24V
110 110V
230 230V

Características Técnicas / Technical characteristics				
	2 Polos / 2 Poles	3 Polos / 3 Poles	4 Polos / 4 Poles	
Resistencia / Endurance				
Resistencia eléctrica / Electrical endurance, (cycles)	10x10 <sup>4</sup>			
Resistencia mecánica / Mechanical endurance, (cycles)	500x10 <sup>4</sup>			
Max. operación de conmutación por hora / Max. switching operation per hour, (cycles)	30			
Conexión de terminales / Terminal connection				
Circuito principal / Main circuit, (mm <sup>2</sup> )	Rigido / Rigid	1,5~6	6~25	6~35
	Flexible	1,5~4	6~16	6~35
Circuito de control / Control circuit, (mm <sup>2</sup> )	Rigido / Rigid	1,5~2,5 / 2x1,5		
	Flexible	1,5~2,5 / 2x1,5		
Par de torsión / Torque, (N.M)	Circuito de potencia / Power circuit	0,8	3,5	3,5
	Circuito de control / Control circuit			
Datos adicionales / Additional data				
Categoría de aplicación / Application category	AC-7a, AC-7b			
Temperatura de operación / Operating temperature, (°C)	-5~+40			

		Tipo de contacto / Type of contact		
		NO	NC	NO+NC
Número de contactos / Contact number	2	 2NO	 2NC	 1NO + 1NC
	3	 3NO	 3NC	
	4	 4NO	 4NC	 2NO + 2NC



⊙ 250/400V  
50/60Hz

IEC 60947-4-1

IEC 61095



EN 61095



## OPP - Protectores de sobrecarga / Surge protection devices

Los dispositivos DPS (SPD) de la gama PROTEC están diseñados para la protección del sistema eléctrico, limitar las sobretensiones transitorias de origen atmosférico y desviar las ondas de corriente a tierra, a fin de limitar la amplitud de esta sobretensión a un valor que no sea peligroso para la instalación eléctrica y el equipo eléctrico de conmutación y control.

*SPD devices of the PROTEC range are designed to protect the electrical system, limit transient overvoltages of atmospheric origin and divert current to earth, in order to limit the amplitude of this overvoltage to a value that is not dangerous for the electrical installation and/or electrical switches and control equipment.*



El trabajo principal del sistema de protección contra sobretensiones PROTEC-OPP es proteger los dispositivos electrónicos de "sobretensiones" y limitar el voltaje suministrado a un dispositivo eléctrico bloqueando o cortocircuitando la corriente para reducir el voltaje a un umbral seguro. En efecto, si el voltaje del tomacorriente aumenta por encima del nivel aceptado, el protector contra sobretensiones desvía la electricidad adicional hacia el cable de conexión a tierra.

*The main job of the PROTEC-OPP surge protection system is to protect electronic devices from "surges" and limiting voltage supplied to an electric device by either blocking or shorting current to reduce the voltage to a safe threshold. In effect, if the voltage from the outlet surges or spikes rises above the accepted level, the surge protector diverts the extra electricity into the grounding wire.*

CARACTERÍSTICAS TÉCNICAS / TECHNICAL CHARACTERISTICS	
Clase / Class	II
Nº de polos/ N° of poles	1, 1+1, 2, 3, 3+1, 4
Voltaje nominal / Rated voltage (Un, V)	230 / 400V
Voltaje de funcionamiento continua Max. / Max. continuous operating voltage (Uc,V)	275V / 320V / 285V / 440V
Voltaje de funcionamiento continua Max. / Max. continuous operating voltage N-PE (Uc,V)	255V
Corriente nominal de descarga / Nominal discharge current	10kA
Corriente maxima de descarga / Maximum discharge current	20kA
Nivel de protección de voltaje / Voltage protection level (Up, kV)	1.1 / 1.3 / 1.5 / 1.8kV
Nivel de protección de voltaje / Voltage protection level (5kA Up, kV)	1.05 / 1.25 / 1.45 / 1.75kV
Nivel de protección de voltaje / Voltage protection level (N-PE Up, kV)	1.5kV
Capacidad de extinción / Extinguishing capacity (N-PE) Ifi A	100A
Fusible de respaldo / Backup fuse (gL / gG, A)	80A
Tiempo de respuesta (tA, ns)	25
Tiempo de respuesta N-PE (tA, ns)	100
Temperatura sobrevoltaje soportado / Tolerated temperature over-voltage (5s) UT, V	335
Temperatura ambiente / Ambient temperature (°C)	-40 ~+ 80°C
Estado de funcionamiento e indicación de fallo / Operating state and fault indication	(verde/green) / (rojo/red)
Grado de protección / Protection rating	IP20
Capacidad de conexión / Connection capacity	35mm2

### Ventajas / Advantages

- Alta capacidad de descarga y baja tensión residual. / High discharge capacity and low residual voltage.
- Diseño modular e instalación en carril DIN. / Modular design and DIN rail installation.
- Unidad de función extraíble. / Removable function unit.
- Compatible con contacto auxiliar 1NO+1NC. / Compatible with auxiliary contact 1NO+1NC.
- Diseño modular con dimensiones estándar / Modular design with standard dimentions.
- Diseñado con ventana de indicación de estado / Designed with modular indicator window.

OPP - Protectores de sobrecarga / Surge protection devices (20kA)

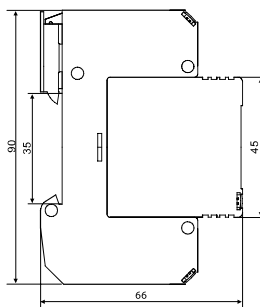
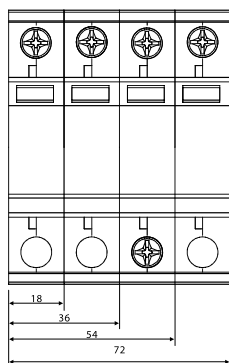

Referencia Reference	Max. corriente cont. en operacion Max. cont. operating voltage (Uc, V)	Corriente descarga nominal Nominal discharge current (In, kA)	Corriente descarga max. Nominal discharge current (Imax, kA)	Protección voltage Voltage protection (Up, kV)	Nº de Polos Num. of Poles	Modo de protección Protection Mode
OPP275201	275	10	20	1.1	1	L/N-PE
OPP275201+1	275	10	20	1.1	1+1	L-N, N-PE
OPP275202	275	10	20	1.1	2	L-PE, N-PE
OPP275203	275	10	20	1.1	3	L-PE
OPP275203+1	275	10	20	1.1	3+1	L-N, N-PE
OPP275204	275	10	20	1.1	4	L-PE, N-PE
OPP320201	320	10	20	1.3	1	L/N-PE
OPP320201+1	320	10	20	1.3	1+1	L-N, N-PE
OPP320202	320	10	20	1.3	2	L-PE, N-PE
OPP320203	320	10	20	1.3	3	L-PE
OPP320203+1	320	10	20	1.3	3+1	L-N, N-PE
OPP320204	320	10	20	1.3	4	L-PE, N-PE
OPP385201	385	10	20	1.5	1	L/N-PE
OPP385201+1	385	10	20	1.5	1+1	L-N, N-PE
OPP385202	385	10	20	1.5	2	L-PE, N-PE
OPP385203	385	10	20	1.5	3	L-PE
OPP385203+1	385	10	20	1.5	3+1	L-N, N-PE
OPP385204	385	10	20	1.5	4	L-PE, N-PE
OPP440201	440	10	20	1.8	1	L/N-PE
OPP440201+1	440	10	20	1.8	1+1	L-N, N-PE
OPP440202	440	10	20	1.8	2	L-PE, N-PE
OPP440203	440	10	20	1.8	3	L-PE
OPP440203+1	440	10	20	1.8	3+1	L-N, N-PE
OPP440204	440	10	20	1.8	4	L-PE, N-PE
<b>PROTECTORES EN VOLTAJE DC / DC VOLTAGE SPDs (Instalaciones fotovoltaicas / Photovoltaic installations)</b>						
OPP0600402	600	20	40	2,5	2	+/-PE, -/+PE
OPP1100402	1100	20	40	4	2	+/-PE, -/+PE
OPP1100403	1100	20	40	4	3	+/-PE, -/+PE

**OPHQ1-P - Interruptor horario modular de segmento / Modular segment timer switch**

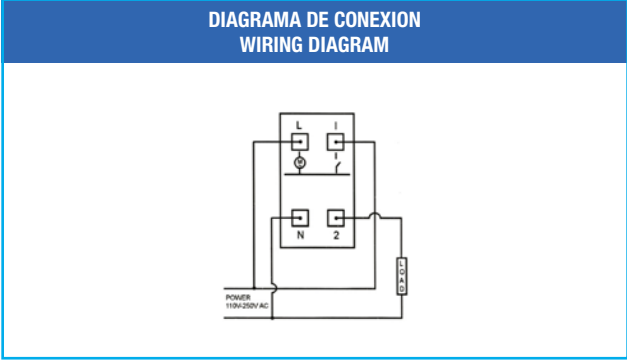
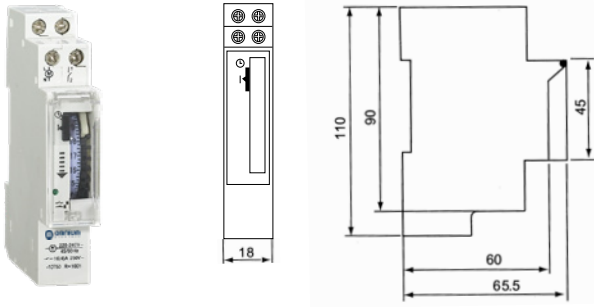

- Consumo / Consumption: 2.5VA
- Contacto / Contact: 1NO
- Capacidad de contacto / Contact capacity: 16A 250V AC (COS = 1)  
2.5A/250V AC (COS = 0.6)
- Resistencia eléctrica / Electrical endurance: 10<sup>5</sup> ciclos / cycles
- Resistencia mecánica / Mechanical endurance: 10<sup>7</sup> ciclos / cycles

- Programa / Program: 24 horas / hours
- Segmentos / Segments: 96
- Intervalo de programación / Program interval: 15m
- Temperatura ambiente / Ambient temp.: -10°C~+50°C
- Type / Tipo: Motor de cuarzo / Quartz-controlled motor
- Exactitud / Accuracy: ±1s per day at 20°C
- Autonomía: 70 horas / Reserve: 70 hours

230V  
50/60Hz

IEC 60669-1:2018

**OPHQ3-P - Interruptor horario modular de segmento / Modular segment timer switch**

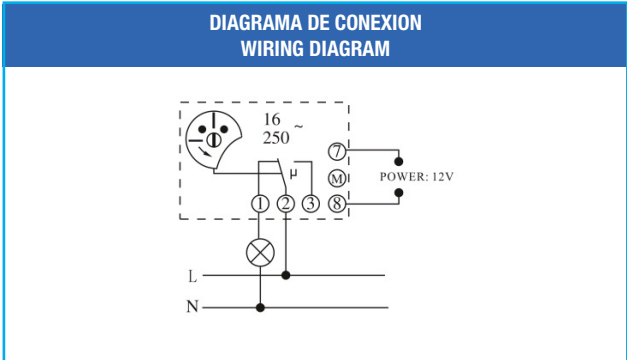
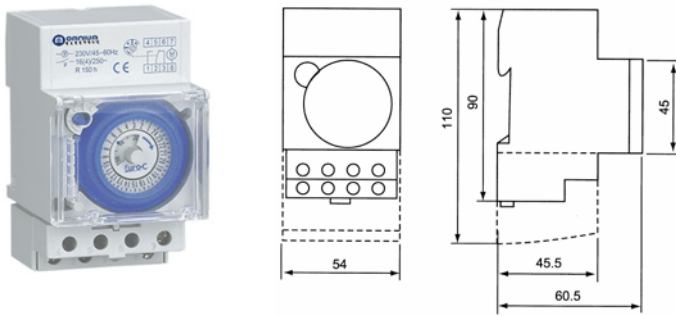

- Consumo / Consumption: 2.5VA
- Capacidad de contacto / Contact capacity: 16A 250V AC
- Resistencia eléctrica / Electrical endurance: 10<sup>5</sup> ciclos / cycles
- Resistencia mecánica / Mechanical endurance: 10<sup>7</sup> ciclos / cycles
- Programa / Program: 24 horas / hours
- Segmentos / Segments: 48
- Intervalo de programación mín. / Min. program interval: 30m

- Temperatura ambiente / Ambient temperature: -20°C~+50°C
- Unidad: motor de cuarzo / Drive: Quartz-controlled motor
- Precisión / Working precision: ±1s per day at 20°C
- Autonomía: 150 horas / Reserve: 150 hours

230V  
50/60Hz

IEC 60669-1:2018

**OPHD2-PR - Interruptor modular programable digital / Modular digital timer switch**

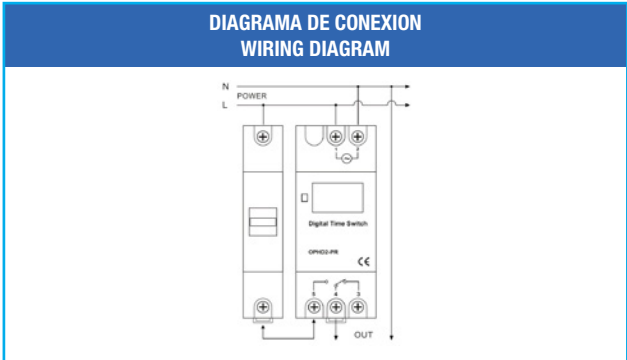
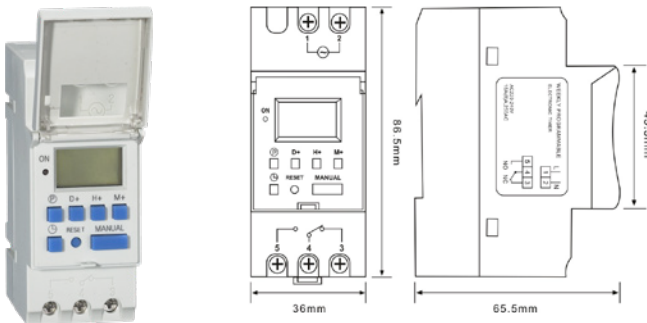

- Resistencia mecánica / Mechanical endurance: 10<sup>7</sup> ciclos / cycles
- Programa 24h + prog. semanal / Program: 24h + week program
- Precisión / Working precision: ≤2 sec/day (25°C)
- Intervalo de programación mín. / Min. program interval: 1m
- Reserva de energía / Power reserve: 15 días / days
- Temperatura amb. / Ambient temperature: -10°C~+40°C

- Contactos: / Contacts: 1NO+1NC
- Consumo: / Consumption: 4VA máx.
- Capacidad de contacto / Contact capacity: 16A 250V AC (COS = 1)  
2.5A/250V AC (COS = 0.6)
- Lámpara incandescente / Incandescent lamp: 1000W
- Resistencia eléctrica / Electrical endurance: 10<sup>5</sup> ciclos/cycles

230V  
50/60Hz

IEC 60669-1:2018

**OPHSC1D - Interruptor horario automático modular / Modular automatic timer switch**

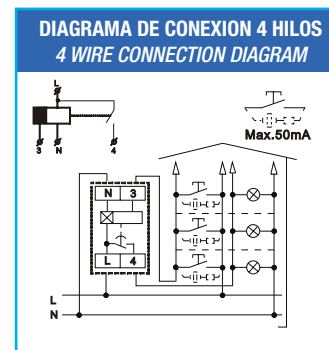
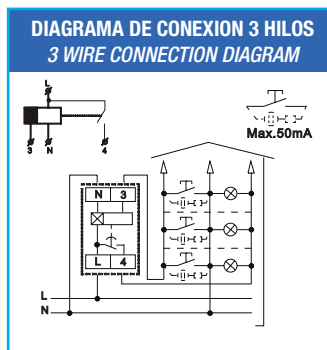
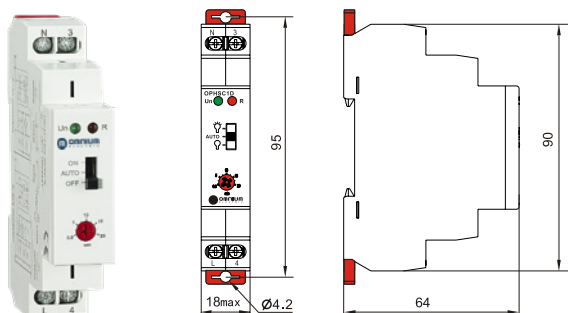

TIPO DE LÁMPARAS TYPES OF LAMPS	
	2000W
	2000W
	1000W
	900W (125 uF)
	400W
	300W

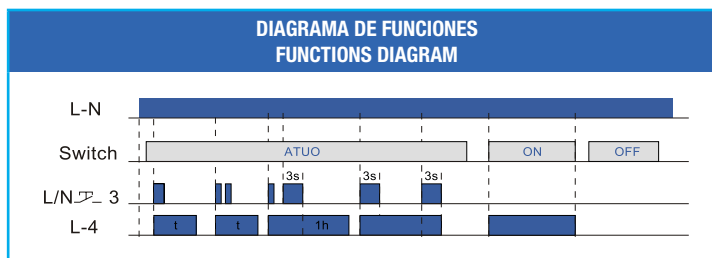
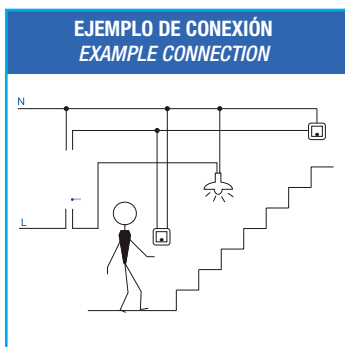

- Tipo: Electromecánico con retardo / *Electromechanical with delay*
- Capacidad de contacto / *Contact capacity: 16A 250V AC*
- Rango de ajuste / *Time setting range: 0.5, 5, 10, 15, 20m*
- Intervalo de programación / *Min. program interval: 30s.*
- Interruptor / *Slide Switch: manual/auto*

- Resistencia eléctrica / *Electrical endurance: 10<sup>6</sup> ciclos / cycles*
- Resistencia mecánica / *Mechanical endurance: 10<sup>7</sup> ciclos / cycles*
- Temperatura ambiente / *Ambient temp.: -20°C~+55°C*
- Max. Conductor. (mm<sup>2</sup>) sólido 1x2,5 o 2x1,5 / con manga 1x2,5

230V  
50/60Hz

IEC 60947-5-1  
EN 61812-1  
EN 60669-2-3

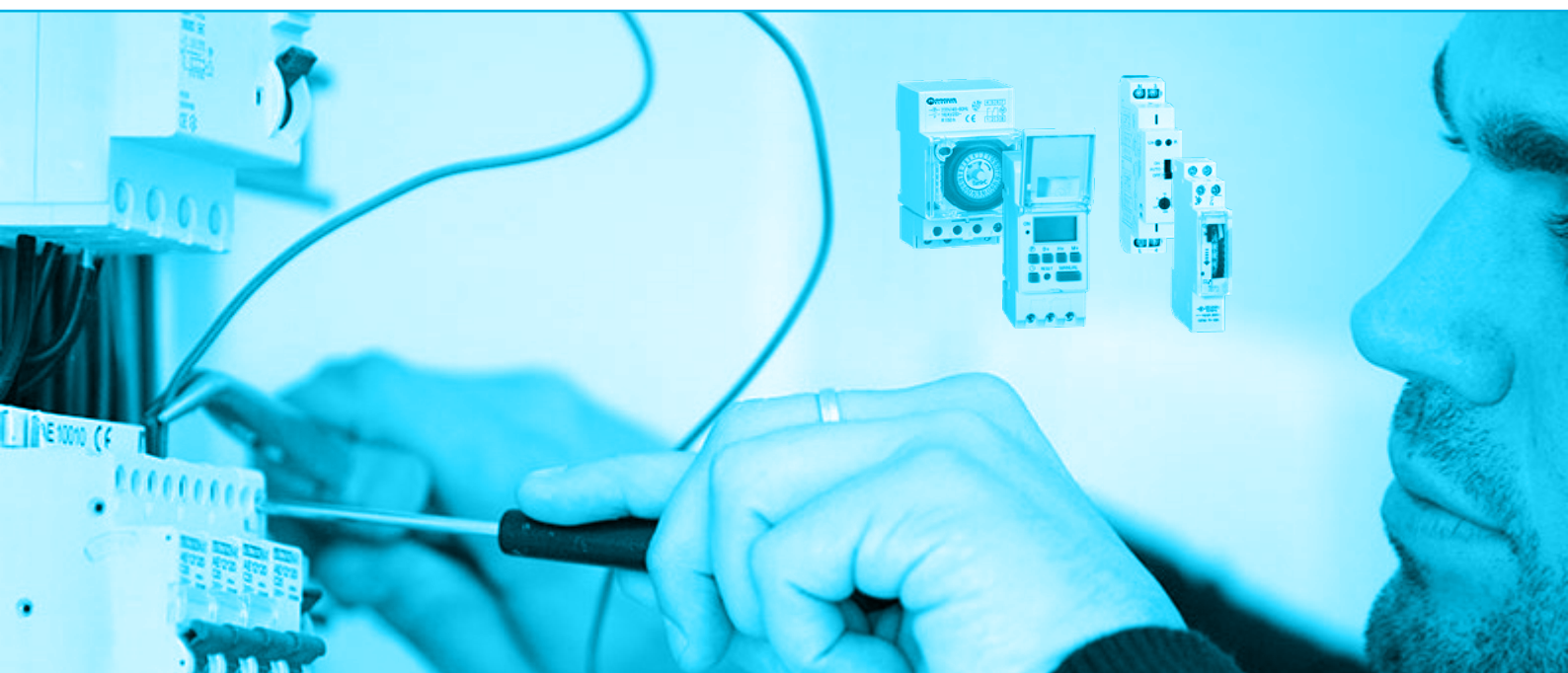



**OPHSFT\* - Relé horario de única función / Single function time relay**

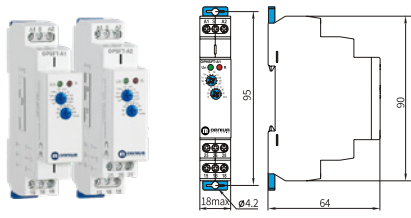

- Relé monofunción con posibilidad de ajuste de tiempo mediante potenciómetro / *Single-function relay with possibility of time setting by a potentiometer.*
- Elección de 2 funciones: A: Retardo ON B: Retardo OFF / *Choice of 2 functions: A: Delay ON B: Delay OFF*
- Escala de tiempo 0,1 s-10 días divididos en 10 rangos / *Time scale 0,1 s - 10 days divided into 10 ranges.*
- El estado del relé se indica mediante LED / *Relay status is indicated by LED.*
- Adecuado para aplicaciones donde se conocen los requisitos de función y tiempo / *Suitable for applications where function and time requirements are known.*
- Max. Conductor. 1 x 2,5 / 2 x 1,5 / 1 x 2,5 (12AWG)

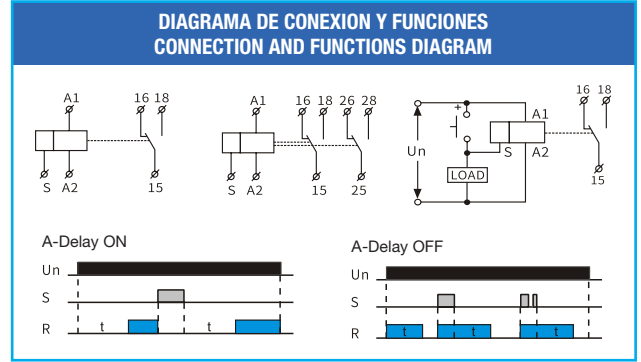

AC/DC 12-240V  
AC 230V  
50/60Hz

IEC 609447-5-1  
EN 61812-1

**OPHMFT\* - Relé de horario - funciones múltiples / Multifunction time relay**

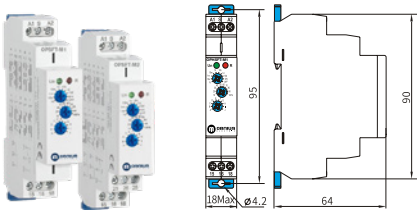

- 10 funciones / *10 functions:*
- 5 funciones de tiempo controladas por tensión de alimentación / *5 time functions controlled by supply voltage.*
- 4 funciones de tiempo controladas por entrada de control / *4 time functions controlled by control input.*
- 1 función de relé de enclavamiento / *1 function of latching relay.*
- Función fácil y bien organizada y ajuste de rango de tiempo mediante interruptores giratorios / *Comfortable and well-arranged function / time-range setting by rotary switches.*
- El estado del relé se indica mediante LED / *Relay status is indicated by LED.*
- Para electrodomésticos, control de luces, calefacción, motores, bombas y ventiladores / *Used for electrical appliances, lighting control, heating, motors, pumps and fans.*
- Max. Conductor. 1 x 2,5 / 2 x 1,5 / 1 x 2,5 (12AWG)

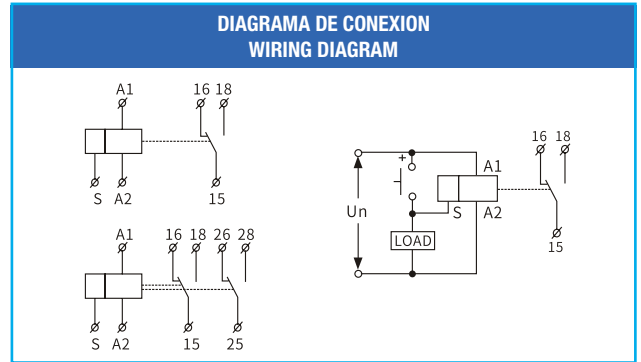

AC/DC 12-240V  
AC 230V  
50/60Hz

IEC 609447-5-1  
EN 61812-1

Rango de tiempo / Time range

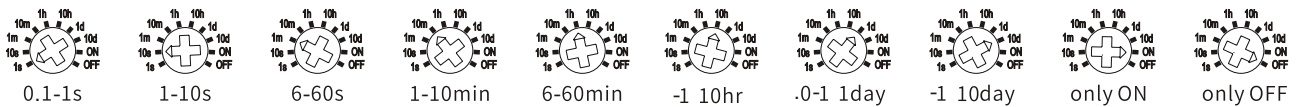

**OPH\*FT\* - Referencias disponibles / Available references**

Referencia Reference	Función Function	Tipo de contacto Contact type	Capacidad de contacto AC1, A Contact capacity AC1, A	Rango de Voltaje de Alimentación Supply voltage range
OPHSFT-A1/230	con retardo de 0,1s-10 días / ON delay 0,1s-10 days	1xSPDT	16	230V AC
OPHSFT-A1/240	con retardo de 0,1s-10 días / ON delay 0,1s-10 days	1xSPDT	16	12-240V AC/DC
OPHSFT-A2/230	con retardo de 0,1s-10 días / ON delay 0,1s-10 days	2xSPDT	16	230V AC
OPHSFT-A2/240	con retardo de 0,1s-10 días / ON delay 0,1s-10 days	2xSPDT	16	12-240V AC/DC
OPHSFT-B1/230	con retardo de 0,1s-10 días / ON delay 0,1s-10 days	1xSPDT	16	230V AC
OPHSFT-B1/240	con retardo de 0,1s-10 días / ON delay 0,1s-0 days	1xSPDT	16	12-240V AC/DC
OPHSFT-B2/230	con retardo de 0,1s-10 días / ON delay 0,1s-10 days	2xSPDT	16	230V AC
OPHSFT-B2/240	con retardo de 0,1s-10 días / ON delay 0,1s-10 days	2xSPDT	16	12-240V AC/DC
OPHMFT-A1/230	A, B, C, D, E, F, G, H, I, J	1xSPDT	16	230V AC
OPHMFT-A1/240	A, B, C, D, E, F, G, H, I, J	1xSPDT	16	12-240V AC/DC
OPHMFT-M1/230	A, B, C, D, E, F, G, H, I, J	2xSPDT	16	230V AC
OPHMFT-M2/240	A, B, C, D, E, F, G, H, I, J	2xSPDT	16	12-240V AC/DC



## OPHMFT\* - Funcionalidades disponibles / Available functions

### A: Retardo en el encendido / On delay

Cuando se aplica el voltaje de entrada "Un", inicia el retardo de temporización "t". Los contactos "R" cambian al estado cerrado cuando se completa el retardo de "t". Los contactos "R" vuelven a su estado abierto cuando se cancela "Un". La señal de disparo "S" no es válida para la función "A".

*When the input voltage "Un" is applied, timing delay "t" begins. Contacts "R" switch to close status when time delay "t" is complete. Contacts "R" return to their open status when "Un" is cancelled. Triggering signal "S" is invalid for function "A".*

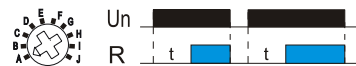

### B: Retardo de apagado / OFF delay

Cuando se aplica el voltaje de entrada "Un", los contactos "R" cambian al estado cerrado mientras inicia el retardo "t". Cuando se completa el retardo de "t", los contactos vuelven al estado abierto. Al cancelar "Un" antes de que se complete "t", los contactos vuelven a estatus abierto. La señal de disparo "S" no es válida para la función "B".

*When input voltage "Un" is applied, contacts "R" switch to close status while time delay t begins. When time delay "t" is complete, contacts return to open status. Upon cancellation of "Un" before "t" is complete, contact return to open status. Triggering signal "S" is invalid for function "B".*



### C: Ciclo de retardo (a partir del estado apagado) / Delay cycling (starting from OFF status)

Cuando se aplica el voltaje de entrada "Un", inicia el retardo "t". Los contactos "R" cambian al estado de cerrado cuando se completa este primer "t". Después del segundo "t", los contactos "R" cambian al estado abierto. Dicho ciclo OFF-ON se repite hasta que se cancela "Un". La señal de disparo "S" no es válida para la función "C".

*When input voltage "Un" is applied, time delay "t" begins. Contacts "R" switch to close status when this 1st "t" is complete. After 2nd "t", contacts "R" switch to open status. Such OFF-ON cycle repeats until Un is cancelled. Triggering signal "S" is invalid for function "C".*



### D: Ciclo de retardo (a partir del estado ON) / Delay cycle (Starting from ON status)

Cuando se aplica el voltaje de entrada "Un", los contactos "R" cambian al estado de cerrado y comienza el retardo de "t". Los contactos "R" vuelven al estado abierto cuando se completa el primer "t". Después del segundo "t", los contactos "R" cambian al estado cerrado. Dicho ciclo ON-OFF se repite hasta que se cancela "Un". La señal de disparo "S" no es válida para la función "D".

*When input voltage "Un" is applied, contacts "R" switch to close status and time delay "t" begins. Contacts "R" return to open status when this 1st "t" is complete. After 2nd "t", contacts R switch to close status. Such ON-OFF cycle repeats until "Un" is cancelled. Triggering signal "S" is invalid for function "D".*



### E: Retardo a la desconexión (interrupción de "S") / OFF delay ("S" break)

Cuando se aplica el voltaje de entrada "Un", los contactos "R" cambian a estado cerrado cuando se cierra el interruptor de disparo "S". El retardo de "t" comienza cuando "S" se desconecta. Cuando se completa "t", los contactos "R" cambian al estado abierto. En caso de que "S" se vuelva a cerrar antes de que se complete "t", entonces "t" se restablece automáticamente a cero.

*With input voltage "Un" being applied, contacts "R" switch to close status upon trigger switch "S" being closed. Time delay "t" begins when "S" get disconnected. When "t" is completed, contacts "R" switch to open status. In case "S" is re-closed before completion of "t", then "t" automatically resets to zero.*

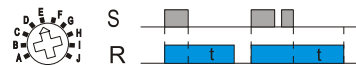

### F: Disparo único / Single shot

Al aplicar el voltaje de entrada "Un", el relé está listo para aceptar la señal de disparo "S". Al aplicar la señal de disparo "S", los contactos del relé "R" se transfieren y comienza el tiempo preestablecido "t". Durante el tiempo de espera, la señal de activación "S" se ignora. El relé se reinicia aplicando el interruptor de disparo "S" cuando el relé no está energizado.

*Upon application of the input voltage "Un", the relay is ready accept trigger signal "S". Upon application of the trigger signal "S", the relay contacts "R" transfer and the preset time "t" begins. During time-out, the trigger signal "S" is ignored. The relay resets by applying the trigger switch "S" when the relay is not energized.*

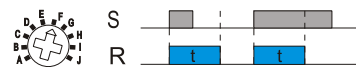

### G: Borde de salida de un solo disparo (no rearmable) / Single shot trailing edge (Non-retriggerable)

Al aplicar el voltaje de entrada "Un", el relé está listo para aceptar la señal de disparo "S". Al aplicar la señal de disparo S, los contactos "R" se transfieren y comienza el tiempo preestablecido "t". Al final del tiempo preestablecido "t", los contactos "R" vuelven a su estado normal al menos que el interruptor de disparo "S" se abra y cierre antes del tiempo de espera "t" (antes de que transcurra el tiempo preestablecido). El ciclo continuo del interruptor de disparo "S" a una velocidad más rápida que el tiempo preestablecido hará que los contactos del relé "R" permanezcan cerrados. Si el voltaje de entrada "Un" es anulado, los contactos "R" vuelven a su estado inicial.

*Upon application of input voltage "Un", relay is ready to accept trigger signal "S". Upon application of the trigger signal "S", contacts "R" transfer and the preset time "t" begins. At the end of the preset time "t", contacts "R" return to their normal status unless the trigger switch "S" is opened and closed prior to time out "t" ( before preset time elapses ). Continuous cycling of the trigger switch "S" at a rate faster than the preset time will cause the relay contacts "R" to remain closed. If input voltage "Un" is cancelled, contacts "R" return to their initial status.*



### H: Retardo de encendido / Apagado / ON/OFF delay

La tensión de entrada "Un" debe aplicarse de forma continua. Cuando se cierra el interruptor de disparo "S", comienza el retardo de "t". Cuando se completa el retardo de "t", los contactos de relé "R" cambian al estado de cierre y permanecen transferidos hasta que se abre el interruptor de disparo "S". Cuando se cancela la tensión de entrada "Un", los contactos de relé "R" vuelven a su estado inicial.

*Input voltage "Un" must be applied continuously. When trigger switch "S" is closed, time delay "t" begins. When time delay "t" is completed, relay contacts "R" switch to close status and remain transferred until trigger switch "S" is opened. Upon input voltage "Un" being cancelled, relay contacts "R" return to their initial status.*

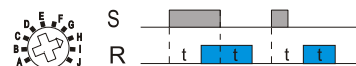

### I: Relé de enclavamiento / Latching relay

La tensión de entrada "Un" debe aplicarse de forma continua. Los contactos de relé "R" cambian de estado cada vez que se acciona el interruptor de disparo "S". Si se cancela la tensión de entrada "U", los contactos de relé "R" vuelven a su estado inicial.

*Input voltage "Un" must be applied continuously. Relay contacts "R" changes status with every trigger switch "S" being actuated. If input voltage "U" is cancelled, relay contacts "R" return to their initial status.*

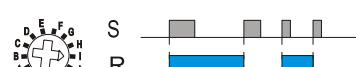

### J: Generador de impulsos / Pulse generator

Al aplicar la tensión de entrada "Un", se envía al relé una única salida de 0,5 segundos después del retardo de "t". Es necesario cancelar la energía y volver a aplicarla para repetir el impulso. El interruptor de disparo "S" no es válido para la función "J".

*Upon application of input voltage "Un", a single output of 0,5 seconds is delivered to relay after time delay "t". Power must be cancelled and re-applied to repeat pulse. Trigger switch "S" is invalid for function "J".*

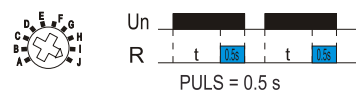

OPH\*FT\* - Características técnicas / Technical characteristics

CARACTERÍSTICAS TÉCNICAS / TECHNICAL CHARACTERISTICS				
Modelo / Model	OPHSFT - A1 / B1	OPHSFT - A2 / B2	OPHMFT - M1	OPHMFT - M2
Función / Function	delay ON		delay OFF	A, B, C, D, E, F, G, H, I, J
Terminales de suministro / Supply terminals	A1 - A2			
Rango de voltaje (W240) / Voltage range (W240)	AC/DC 12 - 240V(50-60Hz)			
Consumo de energía / Power consumption	AC 0,09 - 3VA / DC 0,05-1,7W			
Rango de voltaje (A230) / Voltage range (A240)	AC 230V(50-60Hz)			
Consumo de energía / Power consumption	AC max.6VA/1,3W	AC MAX. 6VA/1,9W	AC max.6VA/1,3W	AC MAX. 6VA/1,9W
Tolerancia de suministro de voltaje / Supply voltage tolerance	-15%; +10%			
Indicador de suministro / Supply indication	LED verde / green LED			
Rangos de tiempo / Time ranges	0,1 s-10 días, encendido, apagado / 0,1s-10days, ON, OFF			
Configuración de tiempo / Time setting	Potenciómetro / potentiometer			
Desviación de tiempo / Time deviation	5%-configuración mecánica / 5%-mechanical setting			
Precisión de repetición / Repeat accuracy	0,2%-estabilidad del valor / 0,2%-set value stability			
Coefficiente de temperatura / Temperature coefficient	0,05%/, at=20°C(0,05%, at=68°F)			
Contacto / Contact	1 x SPDT	2 X SPDT	1 x SPDT	2 X SPDT
Capacidad mínima de ruptura DC / Min. breaking capacity DC	16A / AC1 250VAC / 24VDC			
Indicador de salida / Output indication	500mW			
Vida mecánica / Mechanical life	LED rojo / red LED			
Vida eléctrica(AC1) / Electrical life(AC1)	1 x 10 <sup>7</sup>			
Tiempo de reinicio / Reset time	1 x 10 <sup>6</sup>			
Temperatura de operación / Operating temperature	max. 200ms			
Temperatura de almacenamiento / Storage temperature	-20°C to +55°C (-4°F to 131°F)			
Grado de protección / Protection degree	-35°C to +75°C (-22°F to 158°F)			
Categoría de sobretensión / Over-voltage category	IP40 para panel frontal, IP20 para terminales / IP40 for Front panel / IP20 terminals			
Grado de contaminación / Pollution degree	III.			
	2			

AC/DC 12-240V  
AC 230V  
50/60Hz



IEC 609447-5-1  
EN 61812-1



**OPIR - Rele de impulso AC y DC / Impulse relay AC and DC - 16A**

**Aplicación**

El relé de impulso se utiliza para controlar circuitos de iluminación o para obtener una conexión de cableado simplificada para que las luces se controlen desde lugares duales / múltiples o con voltaje reducido. El dispositivo, caracterizado por un consumo muy bajo de energía, conmuta entre 2 posiciones mecánicas estables al ser energizado por un impulso en su bobina. El dispositivo puede ser controlado mediante un número ilimitado de pulsadores.

**Application**

The impulse relay is used to control lighting circuits or to obtain a simplified wiring connection for lightings to be controlled from dual/multiple places or at reduced voltage. The device, characterized by very low power consumption, switches between 2 stable mechanical positions upon being energized by an impulse on its coil. The device can be controlled by an unlimited number of pushbuttons.

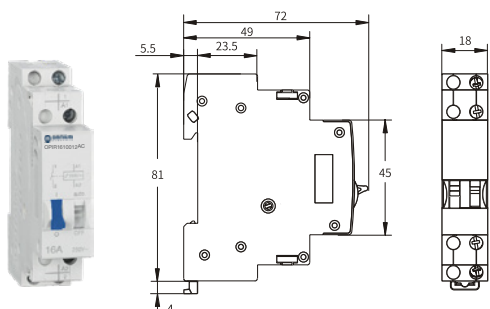

**Ventajas / Advantages**

- Operaciones avanzadas con controles manuales y por impulsos.  
*Advanced operations with both impulse and manual controls.*
- Interruptor selector para desconectar el control remoto para operación de mantenimiento.  
*Selector switch to disconnect remote control for maintenance operation.*

CARACTERÍSTICAS TÉCNICAS / TECHNICAL CHARACTERISTICS	
<b>INFORMACIÓN GENERAL / GENERAL INFORMATION</b>	
Nº de polos / N° of poles	1, 2
Voltaje nominal de aislamiento / Rated insulation voltage (Ui, V)	440V
Voltaje nominal soportada al impulso / Rated impulse withstand voltage (Uimp)	6000
Voltaje nominal de operación / Rated operational voltage (Ue, V)	250V
Corriente nominal / Rated current (Ie, A)	16A
Tipo de contacto / Contact type	1P: 1NO 2P: 2NO, 1NO+1NC, 1CO
Resistencia mecánica y eléctrica / Mechanical and electrical endurance, (ciclos)	1 x 10 <sup>5</sup>
Potencia nominal / Rated power (Pe, KW)	3,5 KW
Max. frecuencia de funcionamiento / Max. operating frequency (ops/min)	5
Temperatura ambiente / Ambient temperature (°C)	-20 ~+ 50°C
Capacidad de conexión en circuito principal / Connection capacity, main circuit (mm <sup>2</sup> )	1-4 (rígido) 1-4 (flexible)
Capacidad de conexión en circuito de control / connection capacity, control circuit (mm <sup>2</sup> )	1-4 (rígido) 1-4 (flexible)
Par de torsión / Torque: (N.m)	1
Tiempo de respuesta N-PE (tA, ns)	100
<b>BOBINA / COIL</b>	
Rango de suministro de voltaje / Supply voltage, range (Uc, %)	85-110V
Voltaje nominal de control / Rated control voltage (V)	AC: 12, 24, 48, 130, 230 DC: 12, 24, 48, 130, 230
Pérdida de potencia de la bobina / Coil power loss (VA)	AC: 19 VA, DC: 9 VA
Modo de control / Control mode	Control de impulsos Control manual
Duración de impulso por voltaje de control / Impulse duration by control voltage	50ms-1s (200ms recomendado)
Tiempo de respuesta / Response time	50 ms



OPIR - Relé de impulso AC y DC / *Impulse relay AC and DC - 16A*



AC

Relé de impulso 16 A, Voltaje AC de la bobina / <i>Impulse Relay 16 A, Coil AC Voltage</i>			
Diagrama de conexión <i>Connection diagram</i>	Referencia <i>Reference</i>	Tipo de contacto <i>Contact type</i>	Voltaje de la bobina U <sub>c</sub> <i>Coil voltage U<sub>c</sub></i>
	OPIR1610012AC	1NO	12V AC
	OPIR1610024AC	1NO	24V AC
	OPIR1610048AC	1NO	48V AC
	OPIR1610130AC	1NO	130V AC
	OPIR1610230AC	1NO	230V AC
	OPIR1620012AC	2NO	12V AC
	OPIR1620024AC	2NO	24V AC
	OPIR1620048AC	2NO	48V AC
	OPIR1620130AC	2NO	130V AC
	OPIR1620230AC	2NO	230V AC
	OPIR1611012AC	1NO+1NC	12V AC
	OPIR1611024AC	1NO+1NC	24V AC
	OPIR1611048AC	1NO+1NC	48V AC
	OPIR1611130AC	1NO+1NC	130V AC
	OPIR1611230AC	1NO+1NC	230V AC
	OPIR1600012AC	1CO	12V AC
	OPIR1600024AC	1CO	24V AC
	OPIR1600048AC	1CO	48V AC
	OPIR1600130AC	1CO	130V AC
	OPIR1600230AC	1CO	230V AC



DC

Relé de impulso 16 A, Voltaje DC de la bobina / <i>Impulse Relay 16 A, Coil DC Voltage</i>			
Diagrama de conexión <i>Connection diagram</i>	Referencia <i>Reference</i>	Tipo de contacto <i>Contact type</i>	Voltaje de la bobina U <sub>c</sub> <i>Coil voltage U<sub>c</sub></i>
	OPIR1610012DC	1NO	12V DC
	OPIR1610024DC	1NO	24V DC
	OPIR1610048DC	1NO	48V DC
	OPIR1610130DC	1NO	130V DC
	OPIR1610230DC	1NO	230V DC
	OPIR1620012DC	2NO	12V DC
	OPIR1620024DC	2NO	24V DC
	OPIR1620048DC	2NO	48V DC
	OPIR1620130DC	2NO	130V DC
	OPIR1620230DC	2NO	230V DC
	OPIR1611012DC	1NO+1NC	12V DC
	OPIR1611024DC	1NO+1NC	24V DC
	OPIR1611048DC	1NO+1NC	48V DC
	OPIR1611130DC	1NO+1NC	130V DC
	OPIR1611230DC	1NO+1NC	230V DC
	OPIR1600012DC	1CO	12V DC
	OPIR1600024DC	1CO	24V DC
	OPIR1600048DC	1CO	48V DC
	OPIR1600130DC	1CO	130V DC
	OPIR1600230DC	1CO	230V DC

## OPVR - Relé de voltaje trifásico / 3-Phase Voltage Relay

### Aplicación

Para control de equipos móviles (equipos de obra, equipos agrícolas, camiones frigoríficos). protege contra el funcionamiento inverso, para alimentación normal o de emergencia y evita la fase de fallo de un motor de carga.

### Application

For control of mobile equipment (construction equipment, agricultural equipment, refrigerated trucks). protects against reverse operation, for normal or emergency power supply and prevents the failure phase of a charging motor.

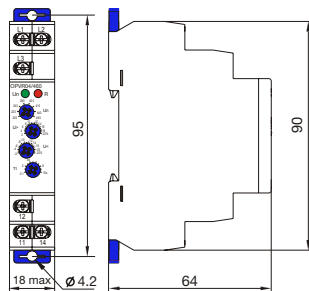
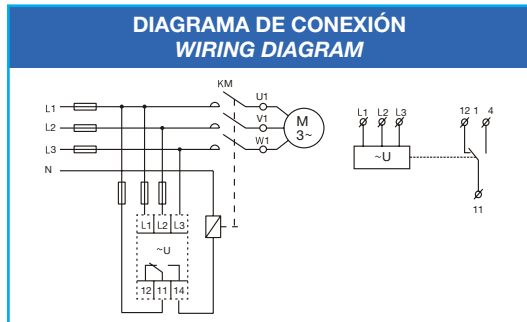

127~460V  
45/65Hz

IEC 60947-5-1

### TIPOS Y CARACTERÍSTICAS / TYPES AND CHARACTERISTICS

Referencias Reference Rango Voltaje / Voltage Range: (127V, 132V, 138V, 220V, 230V, 240V, 254V, 265V (P-N))	Referencias Reference Rango Voltaje / Voltage Range: (220V, 230V, 240V, 380V, 400V, 415V, 440V, 480V (P-P))	Sobrevoltaje Over voltage (uo)	Bajo voltaje Under voltage (uu)	Asimetría Asymmetry (ua)	Retardo Delay time	Secuencia de fase Phase sequence	Falla de fase Phase failure
OPVR03/M265	OPVR03/M460	---	---	---	---	Disponible	Disponible
OPVR04/M265	OPVR04/M460	2-20%	-20-2%	---	0,1-10s	Disponible	Disponible
OPVR05/M265	OPVR05/M460	2-20%	-20-2%	8%	0,1-10s	Disponible	Disponible
OPVR06/M265	OPVR06/M460	2-20%	-20-2%	5%-15%	2s	Disponible	Disponible
OPVR07/M265	OPVR07/M460	---	---	8%	2s	Disponible	Disponible
OPVR08/M265	OPVR08/M460	15%	15%	8%	2s	Disponible	Disponible

### DIAGRAMA DEL PANEL / PANEL DIAGRAM

OPVR03M265 OPVR03M460	OPVR04M265 OPVR04M460	OPVR05M265 OPVR05M460	OPVR06M265 OPVR06M460	OPVR07M265 OPVR07M460	OPVR08M265 OPVR08M460



OPVR - Relé de voltaje trifásico / 3-phase Voltage Relay

CARACTERÍSTICAS TÉCNICAS / TECHNICAL CHARACTERISTICS		
Modelo / Model:	OPVR**M265	OPVR**M460
Funciones / Function	Monitoreo de de voltaje trifásico / Monitoring 3-phase voltage	
Terminales de monitoreo / Monitoring terminals	L1-L2-L3-N	L1-L2-L3
Terminales de suministro / Supply terminals	L1-N	L1-L2
Rango de voltaje / Voltage Range	127 132 138 220 230 240 254 265 (P-N)	220 230 240 380 400 415 440 460 (P-P)
Rango de medición / Measuring range	101-318V	176-552V
Umbral de voltaje / Voltage threshold	2%-20% de (Un) seleccionado	
Umbral asimétrico / Assymetry threshold	5%-15%	
Histéresis / Hysteresis	2%	
Indicador de suministro / Supply indication	Led verde / Green Led	
Tiempo de retardo / Time delay	Ajustable 0,1s-10s, 10%	
Tolerancia de medición / Measurement tolerance	1%	
Retardo de ejecución en el encendido / Run up delay at power up	0,5s tiempo de retardo / Time delay	
Presición de ajuste del konb / Konb setting accuracy	5% del valor de la escala / Scale value	
Tiempo de reinicio / Reset time	1000ms	
Coefficiente de temperatura / Temperature coefficient	0,05% °C / , at=-20°C (0,05% °F, at=68°F)	
Contacto / Contact	1xSPDT 10A / AC1 250VAC / 24VCD	
Capacidad mínima de ruptura DC / Min. breaking capacity DC	500mW	
Indicador de salida / Output indication	Led rojo / Red Led	
Vida mecánica / Mechanical life	1 x 10 <sup>7</sup>	
Vida eléctrica / Electrical life (AC1)	1 x 10 <sup>6</sup>	
Temperatura de operación / Operating temperature	-20°C ~+55°C	
Categoría de sobrevoltaje / Over-voltage category	III	
Grado de contaminación / Pollution degree	2	
Medida máxima de cable / Max. cable size (mm <sup>2</sup> )	Cable sólido max. 1x2,5 o 2x1,5 / y con manguito max. 1x2,5 (AWG12)	

DIAGRAMA DE FUNCIONES  
FUNCTIONS DIAGRAM

Protección contra fallas de fase y secuencia de fases

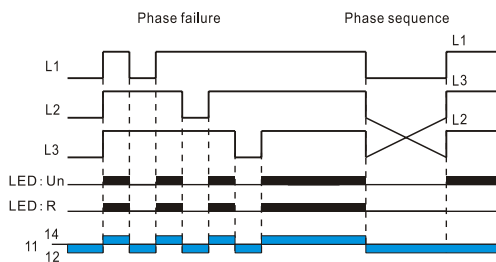

Protección contra sobretensión y subtensión

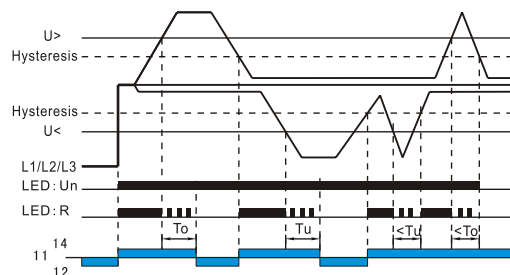

Protección asimétrica

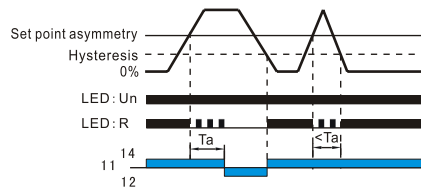

- Retardo de disparo del umbral de sobretensión  
Overvoltage threshold trip delay
- Retardo de disparo del umbral de subtensión  
Undervoltage threshold trip delay
- Retardo de disparo del umbral de asimetría  
Assymetry threshold trigger delay

**OPEM2\* - Medidor de energía monofásico de dos cables / Single phase two wire energy meter**

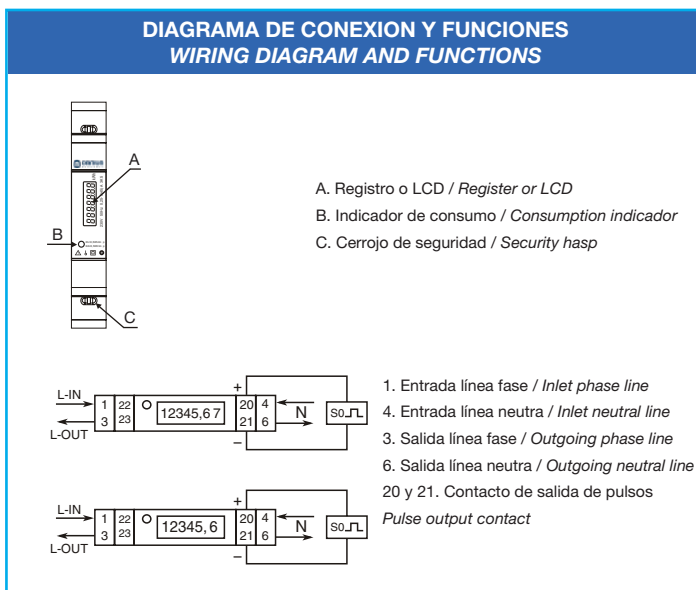
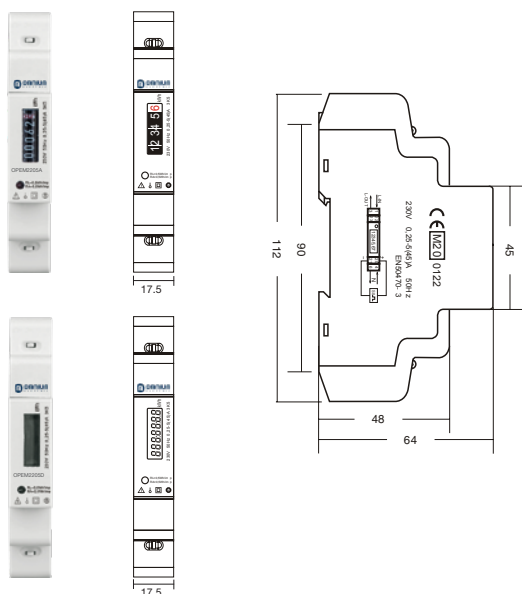

**CARACTERÍSTICAS TÉCNICAS / TECHNICAL CHARACTERISTICS**

Modelo / Model	OPEM2205A	OPEM2205D
Clase / Class	II	
Tipo de pantalla / Screen type	Registro 5+1	Digital 6+2
Voltaje nominal / Rated voltage (Un, V)	230V AC	
Voltaje de funcionamiento / Operating voltage	195- 253V AC	
Corriente básica / Basic current (Ib, A)	5A	
Corriente nominal máxima / Maximum rated current (Imax, A)	45A	
Indicador de consumo / Consumption indicator (led rojo)	Parpadeo en el funcionamiento Flashing at load running	
Tasa de salida de pulsos / Pulse output rate (pins 20 y 21)	1000 / 2000imp / kWh	
Clase de precisión / Accuracy class	B	
Temperatura ambiente / Ambient temperature	-25°C ~+55°C	

230V  
50Hz

CE EN 50470-1  
EN 50470-3

OPEM4 - Medidor de energía trifásico de cuatro cables / Three phase four wire energy meter

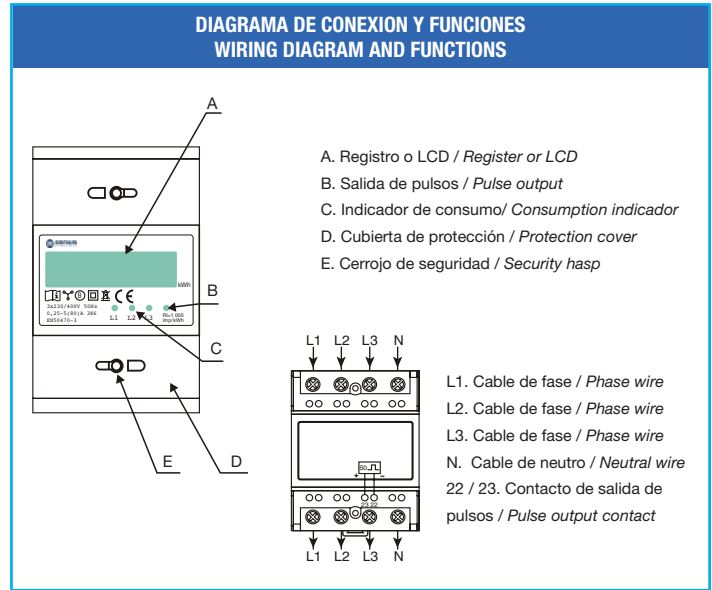
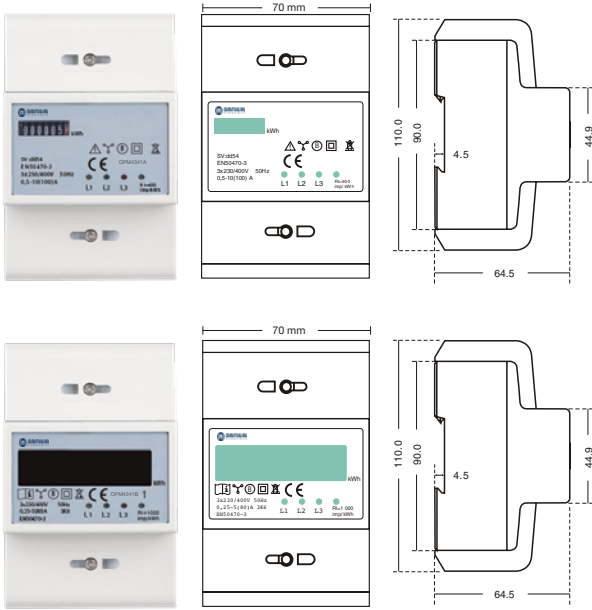

CARACTERÍSTICAS TÉCNICAS / TECHNICAL CHARACTERISTICS

Modelo / Model	OPEM4341A	OPEM4341B
Clase / Class	II	
Tipo de pantalla / Screen type	Registro 5+1	Digital 6+2
Voltaje nominal / Rated voltage (Un, V)	3x230 / 400V AC	
Voltaje de funcionamiento / Operating voltage	3x161 / 279 to 300 / 500V AC	
Corriente básica / Basic current (Ib, A)	5A	
Corriente nominal máxima / Maximum rated current (Imax, A)	80A	
Consumo de energía de corriente / Power consumption of current	≤ 2W / 10VA por fase	
Tasa de salida de pulsos / Pulse output rate	400 / 1000imp / kWh	
Clase de precisión / Accuracy class	B	
Humedad de funcionamiento / Operating humidity	≤ 75%	
Temperatura ambiente / Ambient temperature	-25°C ~+55°C	

230/400V  
50Hz

CE EN 50470-1  
EN 50470-3



OPU - Bases portafusibles modulares / Modular fuseholders



- Tensión nominal: 1000V  
Rated voltage: 1000V
- Corriente nominal: 25A, 32A, 63A, 125A  
Nominal current: 25A, 32A, 63A, 125A

TAMAÑO PORTAFUSIBLES / FUSEHOLDER SIZE: 8,5 x 31mm				
Polos Poles	Módulos Modules	Corriente Current	Voltaje Voltage	Referencia Reference
1	1	6-25A	1000V	OPU0931-1
1+N	1	6-25A	1000V	OPU0931-1N
2	2	6-25A	1000V	OPU0931-2
3	3	6-25A	1000V	OPU0931-3
4	4	6-25A	1000V	OPU0931-4

FUSIBLES / FUSES: 8,5 x 31mm	
Amperaje Amperage	Referencia Reference
6A	OPU0931-06A
8A	OPU0931-08A
10A	OPU0931-10A
12A	OPU0931-12A
15A	OPU0931-15A
20A	OPU0931-20A
25A	OPU0931-25A

TAMAÑO PORTAFUSIBLES / FUSEHOLDER SIZE: 10,3 x 38mm				
Polos Poles	Módulos Modules	Corriente Current	Voltaje Voltage	Referencia Reference
1	1	6-32A	1000V	OPU1038-1
2	2	6-32A	1000V	OPU1038-2
3	3	6-32A	1000V	OPU1038-3
4	4	6-32A	1000V	OPU1038-4

FUSIBLES / FUSES: 10,3 x 38mm	
Amperaje Amperage	Referencia Reference
6A	OPU1038-06A
8A	OPU1038-08A
10A	OPU1038-10A
12A	OPU1038-12A
15A	OPU1038-15A
20A	OPU1038-20A
25A	OPU1038-25A
32A	OPU1038-32A

TAMAÑO PORTAFUSIBLES / FUSEHOLDER SIZE: 14 x 51mm				
Polos Poles	Módulos Modules	Corriente Current	Voltaje Voltage	Referencia Reference
1	1	4-63A	1000V	OPU1451-1
2	2	4-63A	1000V	OPU1451-2
3	3	4-63A	1000V	OPU1451-3
4	4	4-63A	1000V	OPU1451-4

FUSIBLES / FUSES: 14 x 51mm	
Amperaje Amperage	Referencia Reference
16A	OPU1451-16A
25A	OPU1451-25A
32A	OPU1451-32A
40A	OPU1451-40A
50A	OPU1451-50A
63A	OPU1451-60A

TAMAÑO PORTAFUSIBLES / FUSEHOLDER SIZE: 22 x 58mm				
Polos Poles	Módulos Modules	Corriente Current	Voltaje Voltage	Referencia Reference
1	1	10-125A	1500V	OPU2258-1
2	2	10-125A	1500V	OPU2258-2
3	3	10-125A	1500V	OPU2258-3
4	4	10-125A	1500V	OPU2258-4

FUSIBLES / FUSES: 22 x 58mm	
Amperaje Amperage	Referencia Reference
32A	OPU2258-32A
40A	OPU2258-40A
50A	OPU2258-50A
63A	OPU2258-63A
80A	OPU2258-80A
100A	OPU2258-100A
125A	OPU2258-125A

OPL - Lámparas de señal modulares / Modular signal Lamp (1P, 230V)

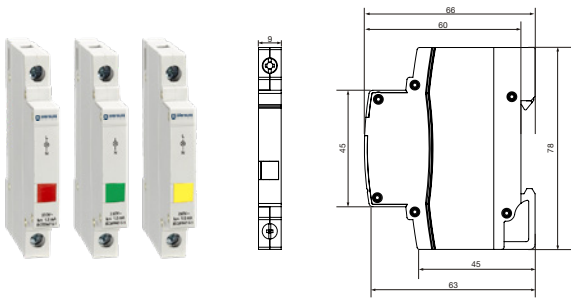

CARACTERÍSTICAS TÉCNICAS / TECHNICAL CHARACTERISTICS				
Modelo / Model	OPL1024* - OPL1230*			
Color* Colour*	<b>R</b>	<b>Y</b>	<b>B</b>	<b>G</b>
No. de Polos / Number of poles	1			
Voltaje nominal Rated voltage (Un, VAC, VCD)	(24V: OPL1024*) (230V: OPL1230*)			
Corriente nominal Rated current (Ie, mA)	≤ 1,6			
Tensión de aislamiento Rated insulation voltage (Ui,V)	500			
iluminación / Illumination	LED			
Potencia de LED LED power, (W)	0,8			

1 Polo / 1 Pole  
Max. Conductor. 6mm<sup>2</sup>  
Par de torsión / Torque: 0,5Nm (max.)



OPL - Lámparas de señal modulares / Modular signal Lamp (3P, 230V)

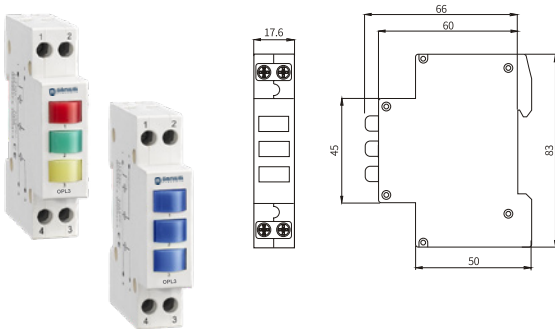

CARACTERÍSTICAS TÉCNICAS / TECHNICAL CHARACTERISTICS						
Modelo / Model	OPL3024* - OPL3048* - OPL3110* - OPL3230*					
Color* Colour*	<b>R</b>	<b>Y</b>	<b>B</b>	<b>G</b>	<b>O</b>	<b>M</b>
No. de Polos / Number of poles	3					
Voltaje nominal Rated voltage (Un, VAC, VCD)	(24V: OPL3024*) (48V: OPL3048*) (110V: OPL3110*) (230V: OPL3230*)					
Resistencia al impulso de sobretensión / Rated impulse withstand voltage (kV)	4					
Tensión de aislamiento Rated insulation voltage (Ui,V)	400					
iluminación / Illumination	LED					
Potencia de LED LED power, (W)	0,8					

3 Polos / 3 Poles  
Max. Conductor. 1,5 ~ 6mm<sup>2</sup>  
Par de torsión / Torque: 1.2Nm (max.)



OPG - Bases de enchufe modulares / Modular sockets



1 - Ref. OPG1-P  
2 - Ref. OPG2-P

- Tensión nominal: / Rated voltage: 250V
- Corriente nominal: / Nominal current: 16A
- Número de módulos: / Number of modules: 2,5
- Con obturador de protección infantil / With child protection





OPB - Peines y barras de conexión de cobre / Copper busbars

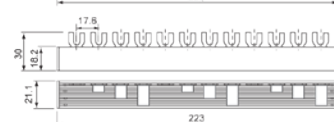
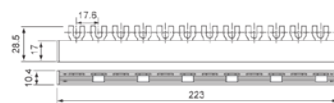
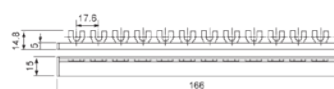
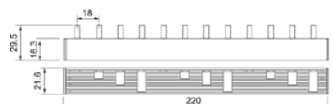
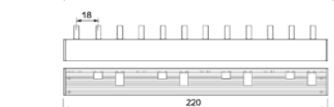
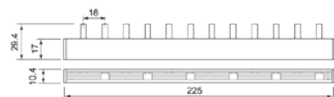
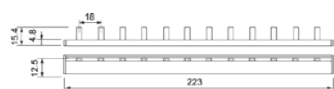
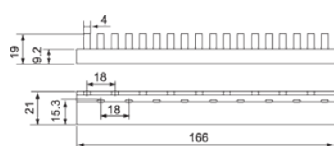

Barra de conexión / Busbar connection 1P + N			
Referencia Reference	Corriente máx. Rated Current	Terminales Terminals	Longitud Length
OPB032/1N	32A	56	1m

Barra de conexión tipo PIN / Busbar connection PIN type 1P, 2P, 3P, 4P			
Referencia Reference	Corriente máx. Rated Current	Terminales Terminals	Longitud Length
OPB063/1	63A	56 (55)	1m
OPB063/2	63A	27	1m
OPB063/3	63A	18	1m
OPB063/4	63A	14	1m
OPBP125/1	125A	56 (55)	1m
OPBP125/2	125A	27	1m
OPBP125/3	125A	18	1m
OPBP125/4	125A	14	1m

Barra de conexión tipo "U" / Busbar connection "U" type 1P, 2P, 3P, 4P			
Referencia Reference	Corriente máx. Rated Current	Terminales Terminals	Longitud Length
OPBU063/1	63A	56 (55)	1m
OPBU063/2	63A	27	1m
OPBU063/3	63A	18	1m
OPBU063/4	63A	14	1m

OPB - Tapa aislante de punta / Insulating end cap



Ref: OPBC/1  
Ref: OPBC/2  
Ref: OPBC/3  
Ref: OPBC/4

CE IEC 61439-1

Repartidor eléctrico / Electrical distribution block



Los bloques de distribución de energía son una forma fácil y conveniente de distribuir un circuito eléctrico a diferentes dispositivos.  
Power distribution blocks are a convenient way of distributing an electrical circuit to a number of devices.

Referencias References	Nº Regletas Nº of Busbars	Especificación Specification	Sección (mm <sup>2</sup> ) Cross Section (mm <sup>2</sup> )	Amperaje Amperage	Medidas Measurements
OFBTT207	2	5 x 5,3mm 2 x 7,5mm	1,5 ~ 6,0 6,0 ~ 16,0	125A	65 x 42 x 50mm
OFBTT211	2	7 x 5,3mm 2 x 7,5mm 2 x 9,0mm	1,5 ~ 6,0 6,0 ~ 16,0 10,0 ~ 16,0	125A	100 x 42 x 50mm
OFBTT215	2	11 x 5,3mm 2 x 7,5mm 2 x 9,0mm	1,5 ~ 6,0 6,0 ~ 16,0 10,0 ~ 16,0	125A	135 x 42 x 50mm
OFBTT407	4	5 x 5,3mm 2 x 7,5mm	1,5 ~ 6,0 6,0 ~ 16,0	125A	65 x 85 x 50mm
OFBTT411	4	7 x 5,3mm 2 x 7,5mm 2 x 9,0mm	1,5 ~ 6,0 6,0 ~ 16,0 10,0 ~ 16,0	125A	100 x 85 x 50mm
OFBTT412	4	4 x 5,3mm 28 x 7,5mm 12 x 9,0mm 4 x 9,0mm	1,5 ~ 6,0 1,5 ~ 16,0 10,0 ~ 25,0 10,0 ~ 50,0	160A	175 x 85 x 50mm
OFBTT415	4	11 x 5,3mm 2 x 7,5mm 2 x 9,0mm	1,5 ~ 6,0 6,0 ~ 16,0 10,0 ~ 16,0	125A	135 x 85 x 50mm

CE UNE EN 60947-7-1  
RoHS

**OPBA - Borne Adaptador / Terminal Adaptor**



Referencias References	Nº Polos Nº of Poles	Tipo Tornillo Screw Type	Torsión Torque	Corriente Current	Voltaje Voltage	Carcasa Housing
OPBA10-070-V	1	Phillips	3Nm (1,5 - 10mm <sup>2</sup> )	70A	600V	PA66 V0
OPBA16-100-V	1	Phillips	4Nm (2,5 - 16mm <sup>2</sup> )	100A	600V	PA66 V0
OPBA35-125-V	1	Phillips	4Nm (6 - 35mm <sup>2</sup> )	125A	600V	PA66 V0
OPBA70-250-V	1	Hex (M8)	20Nm (10 - 70mm <sup>2</sup> )	250A	1000V	PA66 V0

**OPB - Borne adaptador / Terminal adaptor**

Ref: OPBA/1



UNE EN 60947-7-1

**OPUTB - Repartidor modular universal / Universal terminal block**

Los bloques de distribución universales para carril DIN aptos para el uso con conductores de cobre o de aluminio.  
Modular DIN rail universal distribution blocks for use with copper or aluminum conductors.

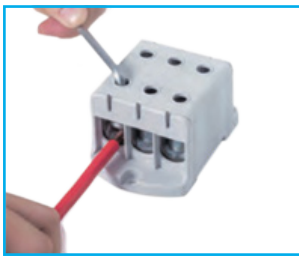
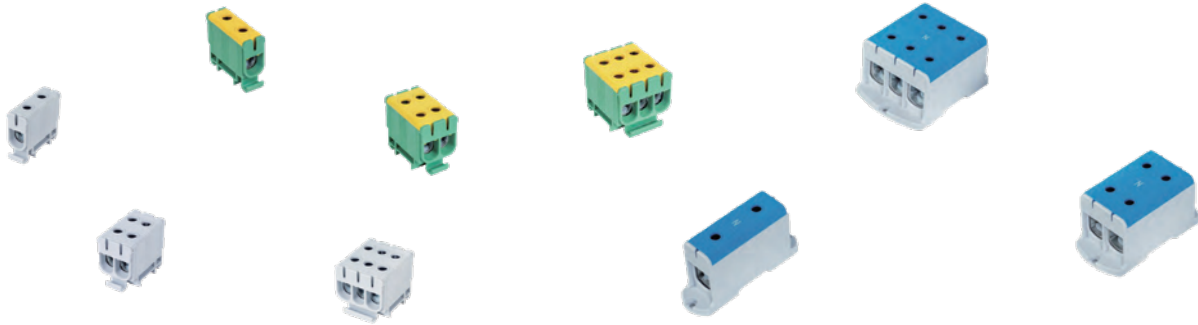

Conexión de cableado  
Wire connection

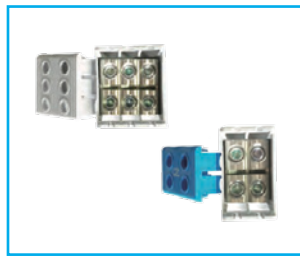

Interior de la carcasa  
Interior of distribution block

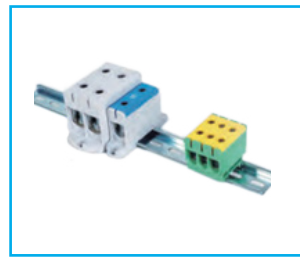

Montaje en carril DIN  
DIN rail mounting

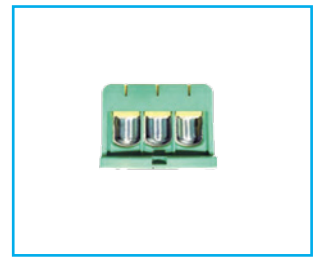

Engrasadas para proteger de la  
corrosión electromecánica.  
Greased to protect from  
electromechanical corrosion.

**OPUTB035\***



Referencias References	Nº Polos Nº of Poles	Torsión Torque	Cable Métrico Metric Wire	Corriente Current	Voltaje Voltage	Carcasa Housing	Dimensiones / Size (Peso / Weight)
OPUTB035-5GBM	5	3Nm (2,5-16mm <sup>2</sup> ) 6Nm (25-35mm <sup>2</sup> )	Cu (2,5-35mm <sup>2</sup> ) Al (2,5-35mm <sup>2</sup> )	Cu 135A Al 120A	1000V	PA66 V0	80 x 45,2 x 40,2mm (117,20g)

\*TORNILLO TIPO HEXAGONAL (M4) / HEXAGON SCREW TYPE (M4)



UNE EN 60947-7-1  
UNE EN 61238-1

## OPUTB - Repartidor modular universal / Universal terminal block

Los bloques de distribución universales para carril DIN aptos para el uso con conductores de cobre o de aluminio.  
Modular DIN rail universal distribution blocks for use with copper or aluminum conductors.

### OPUTB050\*



PARA CONDUCTORES DE 2,5MM <sup>2</sup> HASTA 50MM <sup>2</sup> / FOR CONDUCTORS OF 2,5MM <sup>2</sup> UP TO 50MM <sup>2</sup>							
Referencias References	Nº Polos Nº of Poles	Torsión Torque	Cable Métrico Metric Wire	Corriente Current	Voltaje Voltage	Carcasa Housing	Dimensiones / Size (Peso / Weight)
OPUTB050-1 ▲	1	4Nm (2,5-4mm <sup>2</sup> ) 12Nm (6-50mm <sup>2</sup> )	Cu (2,5-50mm <sup>2</sup> ) Al (6-50mm <sup>2</sup> )	Cu 160A Al 145A	800V	PA66 V0	17,9 x 51 x 43,7mm (33,50g)
OPUTB050-2 ▲	2	4Nm (2,5-4mm <sup>2</sup> ) 12Nm (6-50mm <sup>2</sup> )	Cu (2,5-50mm <sup>2</sup> ) Al (6-50mm <sup>2</sup> )	Cu 160A Al 145A	800V	PA66 V0	31,1 x 51 x 43,7mm (59,80g)
OPUTB050-3 ▲	3	4Nm (2,5-4mm <sup>2</sup> ) 12Nm (6-50mm <sup>2</sup> )	Cu (2,5-50mm <sup>2</sup> ) Al (6-50mm <sup>2</sup> )	Cu 160A Al 145A	800V	PA66 V0	42,3 x 51 x 43,7mm (84,30g)

\* TORNILLO TIPO HEXAGONAL (M5) / HEXAGON SCREW TYPE (M5)

Color Colour ▲	G	B	M
-------------------	---	---	---

### OPUTB095\*



PARA CONDUCTORES DE 16MM <sup>2</sup> HASTA 95MM <sup>2</sup> / FOR CONDUCTORS OF 16MM <sup>2</sup> UP TO 95MM <sup>2</sup>							
Referencias References	Nº Polos Nº of Poles	Torsión Torque	Cable Métrico Metric Wire	Corriente Current	Voltaje Voltage	Carcasa Housing	Dimensiones / Size (Peso / Weight)
OPUTB095-1 ▲	1	20Nm (16-95mm <sup>2</sup> )	Cu (16-95mm <sup>2</sup> ) Al (16-95mm <sup>2</sup> )	Cu 245A Al 220A	800V	PA66 V0	23,7 x 89,1 x 49,6mm (89,80g)
OPUTB095-2 ▲	2	20Nm (16-95mm <sup>2</sup> )	Cu (16-95mm <sup>2</sup> ) Al (16-95mm <sup>2</sup> )	Cu 245A Al 220A	800V	PA66 V0	41,6 x 89,1 x 49,6mm (164,40g)
OPUTB095-3 ▲	3	20Nm (16-95mm <sup>2</sup> )	Cu (16-95mm <sup>2</sup> ) Al (16-95mm <sup>2</sup> )	Cu 245A Al 220A	800V	PA66 V0	60,9 x 89,1 x 49,6mm (236,20g)

\* TORNILLO TIPO HEXAGONAL (M5) / HEXAGON SCREW TYPE (M5)

Color Colour ▲	G	B	M
-------------------	---	---	---

### OPUTB150\*



PARA CONDUCTORES DE 35MM <sup>2</sup> HASTA 150MM <sup>2</sup> / FOR CONDUCTORS OF 35MM <sup>2</sup> UP TO 150MM <sup>2</sup>							
Referencias References	Nº Polos Nº of Poles	Torsión Torque	Cable Métrico Metric Wire	Corriente Current	Voltaje Voltage	Carcasa Housing	Dimensiones / Size (Peso / Weight)
OPUTB150-1 ▲	1	20Nm (35-95mm <sup>2</sup> ) 30Nm (120-150mm <sup>2</sup> )	Cu (35-150mm <sup>2</sup> ) Al (35-150mm <sup>2</sup> )	Cu 320A Al 290A	800V	PA66 V0	28,9 x 96,6 x 59,2mm (161,50g)
OPUTB150-2 ▲	2	20Nm (35-95mm <sup>2</sup> ) 30Nm (120-150mm <sup>2</sup> )	Cu (35-150mm <sup>2</sup> ) Al (35-150mm <sup>2</sup> )	Cu 320A Al 290A	800V	PA66 V0	50,9 x 96,6 x 59,2mm (291,20g)
OPUTB150-3 ▲	3	20Nm (35-95mm <sup>2</sup> ) 30Nm (120-150mm <sup>2</sup> )	Cu (35-150mm <sup>2</sup> ) Al (35-150mm <sup>2</sup> )	Cu 320A Al 290A	800V	PA66 V0	72,8 x 96,6 x 59,2mm (413,30g)

\* TORNILLO TIPO HEXAGONAL (M8) / HEXAGON SCREW TYPE (M8)

Color Colour ▲	G	B	M
-------------------	---	---	---

### OPUTB240\*

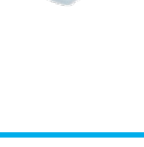

PARA CONDUCTORES DE 35MM <sup>2</sup> HASTA 240MM <sup>2</sup> / FOR CONDUCTORS OF 35MM <sup>2</sup> UP TO 240MM <sup>2</sup>							
Referencias References	Nº Polos Nº of Poles	Torsión Torque	Cable Métrico Metric Wire	Corriente Current	Voltaje Voltage	Carcasa Housing	Dimensiones / Size (Peso / Weight)
OPUTB240-1 ▲	1	12Nm (35-75mm <sup>2</sup> ) 45Nm (95-240mm <sup>2</sup> )	Cu (35-240mm <sup>2</sup> ) Al (35-240mm <sup>2</sup> )	Cu 425A Al 380A	800V	PA66 V0	28,9 x 96,6 x 59,2mm (161,50g)
OPUTB240-2 ▲	2	12Nm (35-75mm <sup>2</sup> ) 45Nm (95-240mm <sup>2</sup> )	Cu (35-240mm <sup>2</sup> ) Al (35-240mm <sup>2</sup> )	Cu 425A Al 380A	800V	PA66 V0	50,9 x 96,6 x 59,2mm (291,20g)
OPUTB240-3 ▲	3	12Nm (35-75mm <sup>2</sup> ) 45Nm (95-240mm <sup>2</sup> )	Cu (35-240mm <sup>2</sup> ) Al (35-240mm <sup>2</sup> )	Cu 425A Al 380A	800V	PA66 V0	72,8 x 96,6 x 59,2mm (413,30g)

\* TORNILLO TIPO HEXAGONAL (M8) / HEXAGON SCREW TYPE (M8)

Color Colour ▲	G	B	M
-------------------	---	---	---



## omnicontrol

Omnicontrol es una serie de aparatos de control y protección industrial de alta calidad que incluye: contactores de corriente alterna, relés térmicos, arrancadores, guardamotores, magneto-térmicos en caja moldeada, botones, selectores, señalizadores, etc..

Esta extensa serie no solo cubre casi cualquier necesidad, sino que también proporciona productos fiables, de fácil y segura instalación, al cuadrista eléctrico profesional.

*Omnicontrol is a full range of high quality industrial control and protection devices including: AC contactors, thermal relays, starters, motor protection devices, MCCB's, pushbuttons, selector switches, signal lamps, etc..*

*This extensive range not only covers almost any need, but also provides professional electrical panel builders with reliable products to ensure safe and easy installations.*

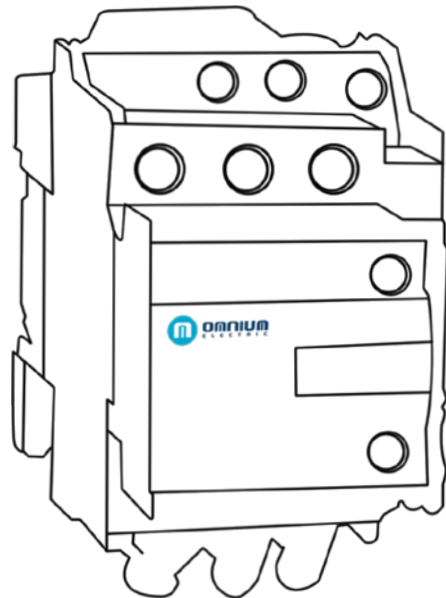



<b>Tablas de conversión para motores de corriente alterna</b> <i>Conversion tables for alternating current motors</i>	47
<b>Identificación de referencia y producto (CLZ*)</b> <i>Product and reference identification (CLZ*)</i>	48
<b>Mini contactores tripolares y tetrapolares AC, 6-12A (CLZ1*)</b> <i>Three and four pole mini AC contactors, 6-12A (CLZ1*)</i>	49
<b>Contactores tripolares y tetrapolares AC, 9-95A (CLZ2*)</b> <i>Three and four pole contactors AC, 9-95A (CLZ2*)</i>	51
<b>Contactores de corriente alterna, 115-630A (CLZ3*)</b> <i>Alternating current contactors, 115-630A (CLZ3*)</i>	52
<b>Contactores para corrección de factor de potencia AC, 25-125A (CLZ4*)</b> <i>Power factor correction contactors AC, 25-125A (CLZ4*)</i>	54
<b>Accesorios para contactores (CLZA*)</b> <i>Accessories for contactors (CLZA*)</i>	56
<b>Relés térmicos electromecánicos (CLY1*)</b> <i>Electromechanical thermal relays (CLY1*)</i>	58
<b>Arrancadores directos en caja de pulsadores (CLX1*)</b> <i>Direct starters in push button case (CLX1*)</i>	60
<b>Arrancadores de estrella - triángulo (CLX2*)</b> <i>Star - delta starters (CLX2*)</i>	61
<b>Dispositivos para la protección de motores (CLW1*)</b> <i>Motor protection devices (CLW1*)</i>	62
<b>Bobinas para contactores (CLZ2C*, CLZ3C*)</b> <i>Coils for contactors (CLZ2C*, CLZ3C*)</i>	66
<b>Interruptores automáticos magnetotérmicos en caja moldeada - Identificación de referencia y producto (CLV*)</b> <i>Moulded case circuit breakers - Product and reference identification (CLV*)</i>	72
<b>Interruptores automáticos magnetotérmicos en caja moldeada (CLV*)</b> <i>Moulded case circuit breakers (CLV*)</i>	73
<b>Accesorios para interruptores automáticos magnetotérmicos en caja moldeada (CLV*)</b> <i>Moulded case circuit breaker accessories (CLV*)</i>	86
<b>Interruptor de aislamiento de carga - Identificación de referencia y producto (CLIS*)</b> <i>Load isolation switch - Product and reference identification (CLIS*)</i>	88
<b>Interruptor de aislamiento de carga (CLIS*)</b> <i>Load isolation switch (CLIS*)</i>	89
<b>Señalizadores LED - Identificación de referencia y producto (CL*)</b> <i>LED signal lights - Product and reference identification (CL*)</i>	92
<b>Señalizadores LED (CL*)</b> <i>LED signal lights (CL*)</i>	93
<b>Botones y selectores rotativos - Identificación de referencia y producto (CLM*/CLP*)</b> <i>Push buttons and rotary switches - Product and reference identification (CLM*/CLP*)</i>	96
<b>Botones y selectores rotativos (CLM*/CLP*)</b> <i>Push buttons and rotary switches (CLM*/CLP*)</i>	98
<b>Accesorios para botones y selectores rotativos</b> <i>Accessories for push buttons and rotary switches</i>	101



**Información técnica**

La función conmutación todo o nada establece e interrumpe la alimentación de los receptores. Esta suele ser la función de los contactores electromagnéticos.

En la mayoría de los casos, el control a distancia resulta imprescindible para facilitar la utilización así como la tarea del operario que suele estar alejado de los mandos de control de potencia.

Como norma general, dicho control ofrece información sobre la acción desarrollada, que se puede visualizar a través de pilotos luminosos o de un segundo dispositivo.

Estos circuitos eléctricos complementarios, llamados “circuitos de esclavización y de señalización”, se realizan mediante contactos auxiliares que se incorporan a los contactores, a los contactores auxiliares o a los relés de automatismo, o que ya están incluidos en los bloques adicionales que se montan en los contactores y los contactores auxiliares.

La conmutación todo o nada también puede realizarse con relés y contactores estáticos.

**Technical information**

The switching function provides all or nothing and interrupts the supply of the receivers. This is usually the role of electromagnetic contactors.

In most cases, the remote control is essential to facilitate the use and the task of the operator who is often away from the power control commands.

As a rule, such monitoring provides information on the action taken and can be viewed through pilot lights or a second device.

These additional circuits called “circuits and signaling enslavement” are performed by auxiliary contacts that are added to the contactor, the contactor relays or relay operator, or which are already included in the additional blocks which are mounted on the contactors and auxiliary contactors.

All or nothing switching can also be done with static relays and contactors.

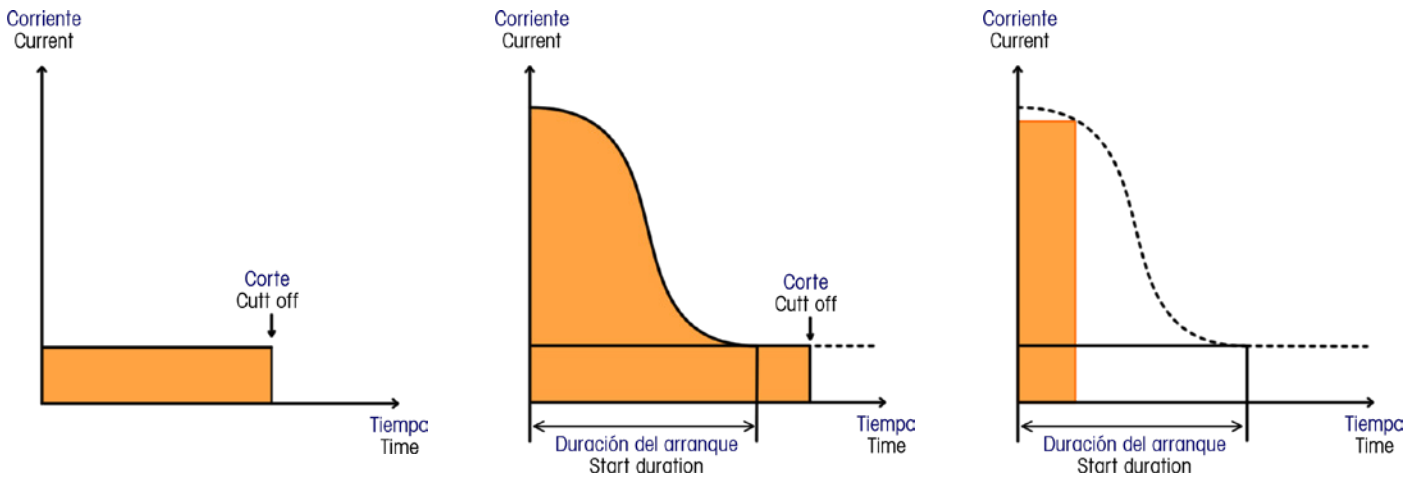

**Tablas de conversión para motores de corriente alterna**  
**Conversion tables for alternating current motors**

Motores monofásicos:  
Single phase motors:

kW	HP	220VA	240VA
0,37	0,5	3,9	3,6
0,55	0,75	5,2	4,8
0,75	1	6,6	6,1
1,1	1,5	9,6	8,8
1,5	2	12,7	11,7
1,8	2,5	15,7	14,4
2,2	3	18,6	17,1
3	4	24,3	22,2
4	5,5	29,6	27,1
4,4	6	34,7	31,8
5,2	7	39,8	36,5
5,5	7,5	42,2	38,7
6	8	44,5	40,8
7	9	49,5	45,4
7,5	10	54,4	50

Motores trifásicos 4 polos 50/60Hz:  
Triple phase motors 4 pole 50/60Hz:

kW	HP	230VA	400VA	415VA	440VA	500VA	690VA
0,37	0,5	2	0,98	-	0,99	1	-
0,55	0,75	2,8	1,5	-	1,36	1,21	-
0,75	1	3,6	1,9	2	1,68	1,5	-
1,1	1,5	5,2	2,5	2,5	2,37	2	-
1,5	2	6,8	3,4	3,5	3,06	2,6	-
2,2	3	9,6	4,8	5	4,42	3,8	-
3	4	11,5	6,3	6,5	5,77	5	-
3,7	5	15,2	-	-	-	-	-
4	5,5	-	8,1	8,4	7,9	6,5	-
5,5	7,5	22	11	11	10,4	9	-
7,5	10	28	14,8	14	13,7	12	-
9	12	-	18,1	17	16,9	13,9	-
11	15	42	21	21	20,1	18,4	12,1
15	20	54	28,5	28	26,5	23	16,5
18,5	25	68	35	35	32,8	28,5	20,02
22	30	80	42	40	39	33	24,2
30	40	104	57	55	51,5	45	33
37	50	130	69	66	64	55	40
45	60	154	81	80	76	65	46,8
55	75	192	100	100	90	80	58
75	100	248	131	135	125	105	75,7
90	125	312	162	165	146	129	94
110	150	360	195	200	178	156	113
132	180	-	233	240	215	187	135
147	200	480	222	260	236	207	128
160	220	-	285	280	256	220	165
185	250	600	-	-	-	-	-
200	270	-	352	340	321	281	203
220	300	720	388	385	353	310	224
250	350	840	437	425	401	360	253
280	380	-	-	-	-	-	-
315	430	-	555	535	505	445	321
335	450	1.080	-	-	-	-	-
355	480	-	605	580	549	500	350
375	500	1.200	-	-	-	-	-
400	545	-	675	650	611	540	390
450	600	1.440	800	-	-	-	-
500	680	-	855	820	780	680	494
560	-	-	950	920	870	760	549
630	-	-	1.045	1.020	965	850	605
710	-	-	1.200	1.140	1.075	960	694
800	1.090	-	-	1.320	1.250	1.100	-
900	1.220	-	-	1.470	1.390	1.220	-

**CLZ\* - Identificación de referencia y producto / Product and reference identification**

CL	XX Producto Product	X		X Polos Poles	XX Contacto / Contact		X Tensión Voltage	
		Corriente Current			NO	NC		
Z1	Minicontactor AC / <i>Minicontactor AC</i> (6A & 12A)	A	6A	3	0	0	0	12V
		B	9A		4	1	1	1
		C	12A		2	2	2	36V
Z2	Contactor tripolar / <i>Triple pole contactor</i> (9A, 12A, 18A, 25A, 32A, 40A, 50A, 60A, 80A, 80A, 95A, 115A, 150A, 170A)	D	18A		3	3	3	48V
		E	25A		4	4	4	110V
		F	32A					5
Z3	Contactor AC / <i>AC Contactor</i> (115A, 150A, 185A, 225A, 265A, 330A, 400A, 500A, 630A)	G	40A					
		H	43A					
		I	50A					6
Z4	Contactor corrección factor de potencia AC / <i>AC Power factor correction contactor</i> (25A, 32A, 43A, 50A, 63A, 80A, 125A)	J	60A					
		K	63A					
		L	65A					
		M	80A					
		N	95A					
		O	115A					
		P	125A					
		Q	150A					
		R	170A					
		S	180A					
		T	225A					
		U	265A					
V	330A							
W	400A							
X	500A							
Y	630A							

CLZ - Contactores de corriente alterna / AC contactors



**CLZ1**  
Minicontactor AC  
*Minicontactor AC*  
(6A & 9A)



**CLZ2**  
Contactor tripolar  
*Triple pole contactor*  
(9A, 12A, 18A, 25A, 32A, 40A, 50A, 60A, 80A, 95A)



**CLZ3**  
Contactor AC  
*AC Contactor*  
(115A, 150A, 185A, 225A, 265A, 330A, 400A, 500A, 630A)



**CLZ4**  
Contactor corrección factor de potencia AC  
*AC Power factor correction contactors*  
(25A, 32A, 43A, 50A, 63A, 80A, 125A)

**CLZ1 - Mini contactores tripolares y tetrapolares / Three and four pole mini contactors / 6-12A**

Normas / Norms		IEC60947-4, GB-14048.4		
Corriente de empleo / Working current (A)	AC-3	6	9	12
	AC-4	2,6	3,5	5
Corriente térmica nominal / Conventional Thermal Current Ith (A)		20	20	20
Tensión de servicio / Operating tension (V)		660V / 690V		
Potencia de motores trifásicos AC3 (kw) Three phase AC3 motor power (kw)	220V	1,5	2,2	3
	380V	2,2	4	5,5
	660V / 690V	3	5,5	7,5
Frecuencia de operación (Maniobras/hora) Operation frequency (Cycles/hour)	Eléctrica Electric	AC-3	1200	
		AC-4	300	
Vida eléctrica (10 <sup>3</sup> maniobras) Electrical life (10 <sup>3</sup> cycles)	AC-3	1200		
	AC-4	250		
Vida mecánica (10 <sup>6</sup> ciclos) / Electrical life (10 <sup>6</sup> cycles)		10		
Fusible / Fuse (A)		16	20	25
Consumo bobinas a 50Hz Coil consumption at 50Hz	Cierre / Closure (VA)	30		
	Mantenimiento / Maintenance (VA)	4,5		
Tensión accionamiento Working tension	Tensión cierre / Closure tension (VA)	85-110% Us		
	Tensión apertura / Opening tension	20 - 75% Us		
Consumo bobinas a 50Hz Coil consumption at 50Hz	Incluidos / Included	1NO / 1NC		
	En cabeza del contactor On contactor head	CLZ1-A**		
	Corriente / Current	10A		
	Capacidad / Capacity	AC - 15:360VA / DC - 13:33W		

Potencia motor Motor power 380Vca - AC3			Intensidad Intensity	Contactos auxiliares Auxiliary contacts	Polos Poles	Referencias References
KW	CV	A				
4	5,5	6	20	1NC	3	CLZ1-A301-*
4	5,5	6	20	1NO	3	CLZ1-A310-*
4	5,5	6	20	-	4	CLZ1-A400-*
4	5,5	9	20	1NC	3	CLZ1-B301-*
4	5,5	9	20	1NO	3	CLZ1-B310-*
4	5,5	9	20	-	4	CLZ1-B400-*

\* Reemplazar con / Replace with: 0 = 12V, 1 = 24V, 2 = 36V, 3 = 48V, 4 = 110V, 5 = 220V, 6 = 380V

Dimensiones y superficie base de instalación / Dimensions and installation base surface



DIAGRAMA DE CONEXION / WIRING DIAGRAM



**CLZ2 - Contactores tripolares y tetrapolares corriente alterna / Three & four pole AC contactors (9-95A)**

			CLZ2-B	CLZ2-C	CLZ2-D	CLZ2-E	CLZ2-F	CLZ2-G	CLZ2-I	CLZ2-L	CLZ2-M	CLZ2-N	
Corriente de empleo (A) Working current (A)	380V	AC-3	9	12	18	25	32	40	50	65	80	95	
		AC-4	4	5,5	7,5	11	15	18,5	22	30	37	45	
	660V	AC-3	6,6	8,9	12	18	21	34	39	42	49	49	
		AC-4	1,5	2	3,8	4,4	7,5	9	12	14	17,3	21,3	
Corriente nominal 1th (A) Nominal current 1th (A)			25	25	32	40	50	60	80	80	125	125	
Tensión de aislamiento (V) Isolating tension (V)			690										
Potencia de motores trifásicos AC-3 (kw) Three-phase motor power AC-3 (kw)		AC-3	2,2	3	4	5,5	7,5	11	15	18,5	22	25	
		AC-4	4	5,5	7,5	11	15	18,5	22	30	37	45	
		AC-3	5,5	7,5	7,5	15	18,5	30	37	37	45	45	
Frecuencia de Operaciones (Maniobras/hora) Operation frequency (Cycles per Hour)	Vida eléctrica Electrical life	AC-3	1200						600				
		AC-4	300										
	Vida mecánica Mechanical life		3600										
Vida eléctrica (10 <sup>3</sup> maniobras) Electrical life (10 <sup>3</sup> cycles)		AC-3	100	100	100	100	80	80	60	60	60	60	
		AC-4	20	20	20	20	20	15	15	15	10	10	
Vida mecánica (10 <sup>3</sup> maniobras) Mechanical life (10 <sup>3</sup> cycles)			1000	1000	1000	1000	800	800	800	800	600	600	
Fusibles (A) Fuses (A)			20	20	32	40	50	63	80	80	100	125	
Conexiones de cable rígido y terminales (mm <sup>2</sup> ) Terminal and rigid cable connections (mm <sup>2</sup> )			2,5	2,5	4	6	10	16	25	25	50	50	
Consumo de bobinas (a 50Hz) Coil consumption (at 50Hz)	Cierre (VA) Closure (VA)		60	60	60	90	90	200	200	200	200	200	
	Mantenimiento (VA) Maintenance (VA)		7	7	7	7,5	7,5	20	20	20	20	20	
	Potencia (W) Power (W)		1,8-2,8	1,8-2,8	1,8-2,8	3-4,5	3-4,5	6-10	6-10	6-10	6-10	6-10	

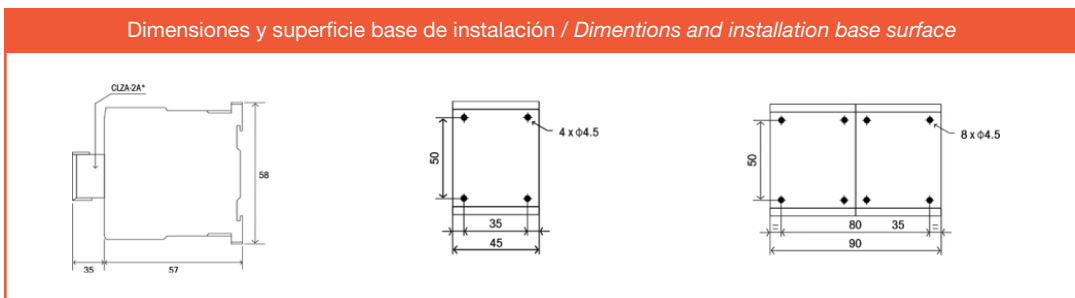
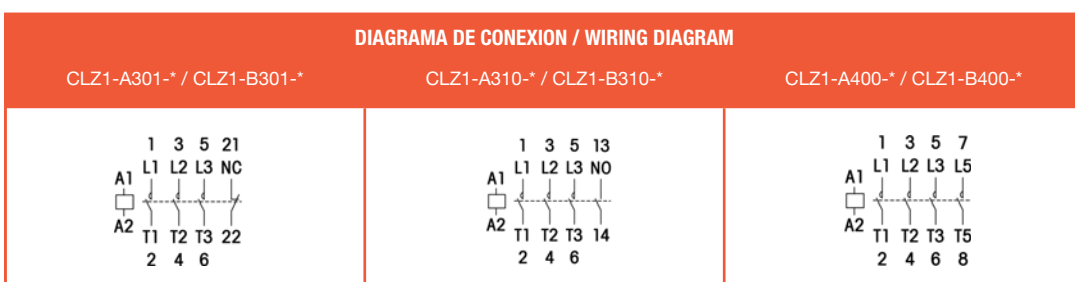
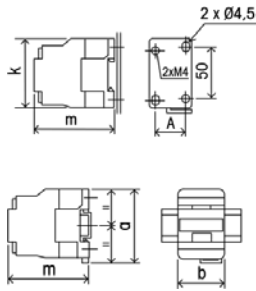

	CLZ2-B	CLZ2-C	CLZ2-D	CLZ2-E	CLZ2-F
m (mm)	80	80	85	93	98
A (mm)	35	35	35	44	44
k (mm)	71	71	71	80	80

	CLZ2-B	CLZ2-C	CLZ2-D	CLZ2-E	CLZ2-F
a (mm)	74	74	74	84	84
b (mm)	46	46	47	57	57
m (mm)	82	82	87	95	100

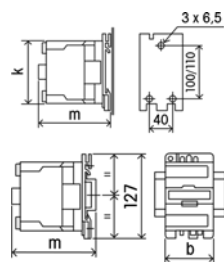

	CLZ2-G	CLZ2-I	CLZ2-L	CLZ2-M	CLZ2-N
m (mm)	114	114	114	125	125
k (mm)	107	107	107	123	123

	CLZ2-G	CLZ2-I	CLZ2-L	CLZ2-M	CLZ2-N
b (mm)	75	75	75	85	85
m (mm)	116	116	116	127	127





**CLZ2 - Contactores tripolares y tetrapolares corriente alterna / Three & four pole AC contactors (9-95A)**

Potencia motor Motor power 380Vca - AC3			Corriente térmica nominal Ith (A) Conventional thermal current Ith (A)	Contactos auxiliares Auxiliary contacts	Polos Poles	Referencias References
KW	CV	A				
4	3,2	9	25	1NC	3	CLZ2-B301-*
4	3,2	9	25	1NO	3	CLZ2-B310-*
4	3,2	9	25	-	4	CLZ2-B400-*
5,5	7,5	12	25	1NC	3	CLZ2-C301-*
5,5	7,5	12	25	1NO	3	CLZ2-C310-*
5,5	7,5	12	25	-	4	CLZ2-C400-*
7,5	10	18	32	1NC	3	CLZ2-D301-*
7,5	10	18	32	1NO	3	CLZ2-D310-*
11	15	25	40	1NC	3	CLZ2-E301-*
11	15	25	40	1NO	3	CLZ2-E310-*
11	15	25	40	-	4	CLZ2-E400-*
15	20	32	50	1NC	3	CLZ2-F301-*
15	20	32	50	1NO	3	CLZ2-F310-*
18,5	25	40	60	1NC+1NO	3	CLZ2-G311-*
18,5	25	40	60	-	4	CLZ2-G400-*
22	30	50	80	1NC+1NO	3	CLZ2-I311-*
22	30	50	80	-	4	CLZ2-I400-*
30	40	65	80	1NC+1NO	3	CLZ2-L311-*
30	40	65	80	-	4	CLZ2-L400-*
37	50	80	125	1NC+1NO	3	CLZ2-M311-*
37	50	80	125	-	4	CLZ2-M400-*
45	60	95	125	1NC+1NO	3	CLZ2-N311-*
45	60	95	125	-	4	CLZ2-N400-*

\* Reemplazar con / Replace with: 0 = 12V, 1 = 24V, 2 = 36V, 3 = 48V, 4 = 110V, 5 = 220V, 6 = 380V

**DIAGRAMA DE CONEXION / WIRING DIAGRAM**

CLZ2-B310-*...CLZ2-F310-*	CLZ2-B301-*...CLZ2-F301-*	CLZ2-G311-*...CLZ2-N311-*	CLZ2-B400-*...CLZ2-N400-*	CLZ2-0310-*...CLZ2-R310-*

**Enclavamiento mecánico para contactores CLZ2 / Mechanical interlocks for CLZ2 contactors**

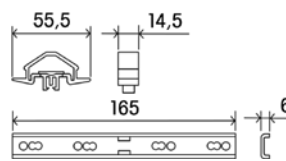
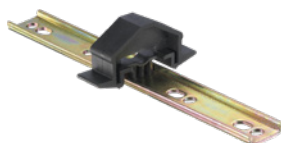
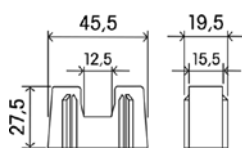
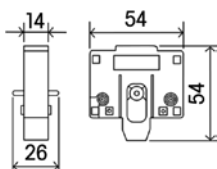

Referencia Reference	Para contactos For contacts
CLZA-M1	CLZ2-B...CLZ2-F
CLZA-M2	CLZ2-G...CLZ2-N

**CLZ3 - Contactores corriente alterna / AC contactors (115-630A)**

			CLZ3-O	CLZ3-Q	CLZ3-S	CLZ3-T	CLZ3-U	CLZ3-V	CLZ3-W	CLZ3-X	CLZ3-Y
Corriente de empleo (A) Working current (A)	380V	AC-3	115	150	185	225	265	330	400	500	630
	660V	AC-4	86	108	118	137	170	235	303	353	462
	1000V			46	50	71	90	112	155	200	232
Corriente nominal Ith (A) / Nominal current Ith (A)			200	200	275	280	300	360	430	580	850
Tensión de servicio (V) / Operating tension (V)			1000	1000	1000	1000	1000	1000	1000	1000	1000
Potencia de motores trifásicos AC-3 (kw) Three phase motor power AC-3 (kw)	380V		55	75	90	110	132	160	200	250	335
	660V		80	100	110	140	160	220	280	330	450
	1000V			64	65	100	100	147	160	185	335
Maniobras por hora (AC3) Operations per hour (AC3)			1200	1200	600	600	600	600	600	600	600
Vida eléctrica (10 <sup>4</sup> maniobras) AC-3 Electrical life (10 <sup>4</sup> cycles) AC-3			120	120	100	100	80	80	80	80	80
Vida mecánica (10 <sup>4</sup> maniobras) Mechanical life (10 <sup>4</sup> cycles)			1000	1000	600	600	600	600	600	600	600
Tipo de fusible asociado (A) Type of associated fuse (A)			225	355	425	500	600	600	600	600	600
Consumo de bobinas Coil consumption	Cierre (VA) Closure (VA)		660	660	966	966	840	840	1380	1380	2076
	Mantenimiento (VA) Maintenance (VA)		54	54	66	66	12	12	22	24	30

Potencia motor Motor power 380Vca - AC3			Intensidad Intensity	Polos Poles	Referencias References
KW	CV	A			
55	75	115	200	3	CLZ3-O300-*
75	100	150	200	3	CLZ3-Q300-*
90	125	185	275	3	CLZ3-S300-*
110	150	225	280	3	CLZ3-T300-*
132	180	265	300	3	CLZ3-U300-*
160	220	330	360	3	CLZ3-V300-*
200	270	400	430	3	CLZ3-W300-*
250	350	500	580	3	CLZ3-X300-*
335	450	630	850	3	CLZ3-Y300-*
55	75	115	200	4	CLZ3-O400-*
75	100	150	200	4	CLZ3-Q400-*
90	125	185	275	4	CLZ3-S400-*
110	150	225	280	4	CLZ3-T400-*
132	180	265	300	4	CLZ3-U400-*
160	220	330	360	4	CLZ3-V400-*
200	270	400	430	4	CLZ3-W400-*
250	350	500	580	4	CLZ3-X400-*
335	450	630	850	4	CLZ3-Y400-*

\* Reemplazar con / Replace with: 1 = 24V, 2 = 36V, 3 = 48V, 4 = 110V, 5 = 220V, 6 = 380V

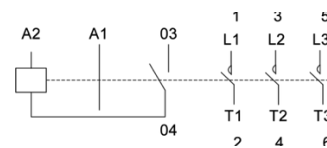

UNE-EN IEC 60947-4-1:2021

**CLZ3 - Contactores corriente alterna / AC contactors (115-630A)**

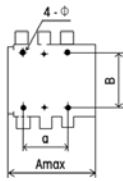
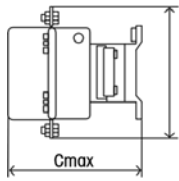

Referencia Reference	A max	B max	C max	a	b	ø
CLZ3-O / CLZ3Q	165	165	172	80	106/120	6,5
CLZ3-S	170	175	182	80	106/120	6,5
CLZ3-T	170	198	182	80	106/120	6,5
CLZ3-U	202	205	215	96	106/120	6,5
CLZ3-V	215	208	220	96	106/120	6,5

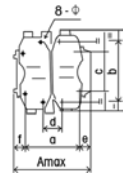
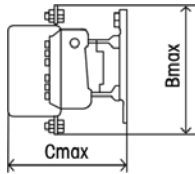

Referencia Reference	A max	B max	C max	a	b	c	d	e	f	ø
CLZ3-W	215	208	220	170	180	120	102	20,5	24,5	8,5
CLZ3-X	235	240	235	170	180	120	120	40,5	24,5	8,5

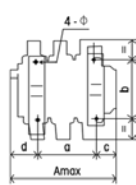
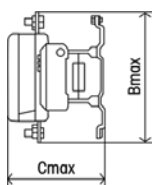

Referencia Reference	A max	B max	C max	a	b	c	d	ø
CLZ3-Y	317	305	257	180	180	70	65,5	10,5



UNE-EN IEC 60947-4-1:2021

**Enclavamiento mecánico para contactores CLZ3 / Mechanical interlocks for CLZ3 contactors**

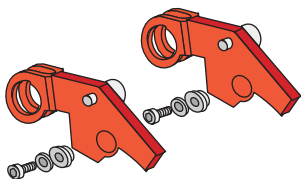

Referencia Reference	Para contactores For contactors
CLZA-M3	CLZ3-O / CLZ3-Q
CLZA-M4	CLZ3-S / CLZ3-T
CLZA-M5	CLZ3-U...CLZ3-X
CLZA-M6	CLZ3-Y

Distancia de contactor (centro a centro) = 310mm  
Contactor distance (Centre to centre) = 310mm

UNE-EN 60947-5-1:2018

**CLZ4 - Contactores corrección factor de potencia / Power factor correction contactors (25-125A)**

		CLZ4-E	CLZ4-F	CLZ4-H	CLZ4-I	CLZ4-K	CLZ4-M	CLZ4-P
Corriente de empleo (A) Working current (A)	220-240V	6,7	8,5	10	15	20	25	40
	400-440V	12,5	16,5	20	25	33,3	40	60
Tensión de aislamiento (Ui V) Insulation tension (Ui V)		660(690)						
Tensión de servicio (Ue V) Operating tension (Ue V)		380 V						
Corriente térmica convencional (Ith A) Conventional thermal current (Ith A)		25	32	43	50	63	80	125
Corriente de servicio (Ile A) Operating current (Ile A)		18	24	29	36	48	58	87
Sobrecarga máxima controlada Surge current capacity		≤20In						
Tensión controlada (Vca) Controlled tension (Vca)		220~ 380						
Ciclos de maniobras por hora Working cycles per hour		120						
Vida eléctrica (10 <sup>3</sup> maniobras) AC-3 Electrical life (10 <sup>3</sup> cycles) AC-3		100						
Vida mecánica (10 <sup>3</sup> maniobras) Mechanical life (10 <sup>3</sup> cycles)		1000						
Secciones de cable circuito principal (Us V) mm <sup>2</sup> Principal circuit cable sections (Us V) mm <sup>2</sup>		4	6	6	10	16	16	25
Tensión de cierre Pickup tension		85%~110%						
Tensión de apertura (Us V) Release tension (Us V)		20%~75%						

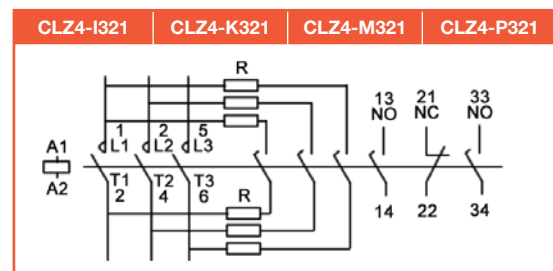
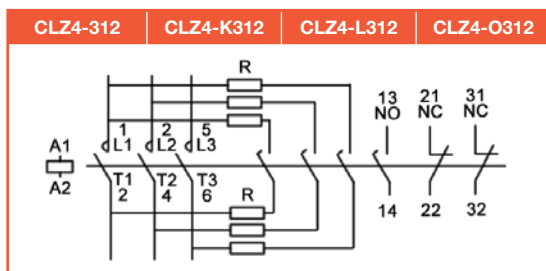
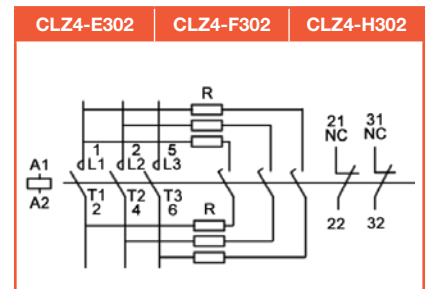
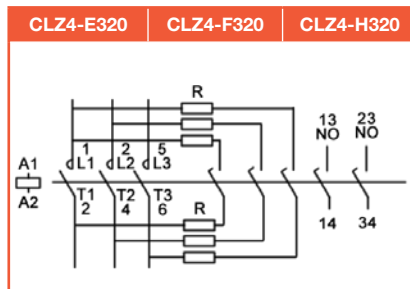
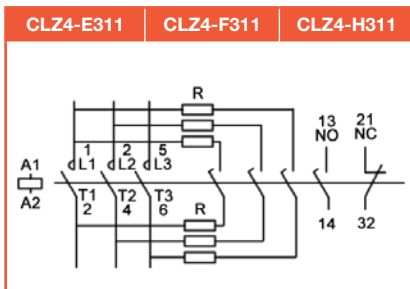

**CLZ4 - Contactores corrección factor de potencia / Power factor correction contactors (25-125A)**

Corriente (A) Current (A)		Condensador (kVar) Condensator (kVar)		Contactos auxiliares Auxiliary contacts	Referencias References
Convencional Conventional	Servicio Operating	220-240V	220-240V		
25	18	6,7	12,5	2 NO	CLZ4-E320-*
				2 NC	CLZ4-E302-*
				1 NO + 1NC	CLZ4-E311-*
32	24	8,5	16,7	2 NO	CLZ4-F320-*
				2 NC	CLZ4-F302-*
				1 NO + 1NC	CLZ4-F311-*
43	29	10	20	2 NO	CLZ4-H320-*
				2 NC	CLZ4-H302-*
				1 NO + 1NC	CLZ4-H311-*
50	36	15	25	2 NO + 1NC	CLZ4-I321-*
				1 NO + 2NC	CLZ4-I312-*
				2 NO + 1 NC	CLZ4-K321-*
63	48	20	33,3	1 NO + 2NC	CLZ4-K312-*
				2 NO + 1 NC	CLZ4-M321-*
				1 NO + 2NC	CLZ4-M312-*
80	58	25	40	2 NO + 1 NC	CLZ4-P321-*
				1 NO + 2NC	CLZ4-P312-*
				2 NO + 1 NC	CLZ4-P312-*

\* Reemplazar con / Replace with: 1 = 24V, 2 = 36V, 3 = 48V, 4 = 110V, 5 = 220V, 6 = 380V

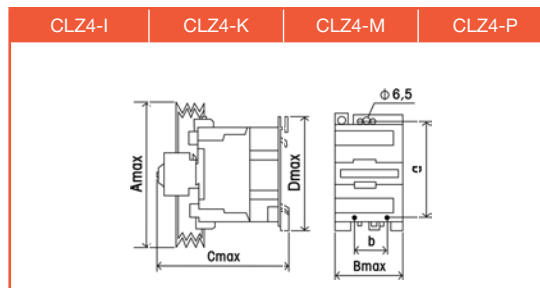
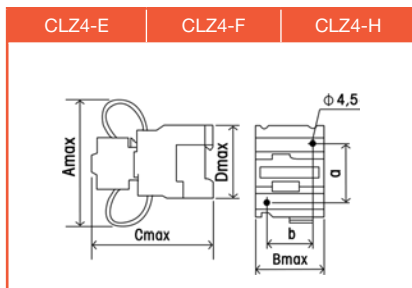

Referencia Reference	Amax	Bmax	Cmax	Dmax	a	b
CLZ4-E	130	47	121	76	50/60	35
CLZ4-F	130	58	130	86	50/60	40
CLZ4-H	140	58	135	86	50/60	40
CLZ4-I	140	79	150	128	100/110	40
CLZ4-K	180	79	150	128	100/110	40
CLZ4-M	180	79	150	128	100/110	40
CLZ4-P	200	87	157	128	100/110	40





**CLZA - Accesorios para contactores / Accessories for contactors**

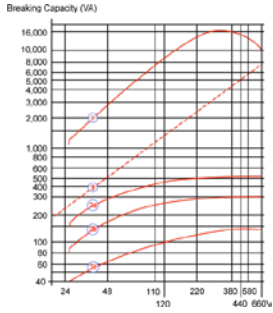

Tensión de servicio / Operating voltage	660 V AC
Tensión de aislamiento / Rated insulation voltage	690 V AC
Corriente Térmica / Rated thermal current	10 A
Unidad protección de corto circuito / Short circuit protection unit	fusible auto-extinguible / self-quenching fuse: gG 10 A
Grado de protección / Protection grade	I.P.20
Capacidad de terminal / Terminal capacity	1X1,0mm <sup>2</sup> ... 2 x 2,5mm <sup>2</sup>
Temperatura ambiente / Ambient temperature	-25°C...+50°C
Vida mecánica / Mechanical life	1 X 10 <sup>7</sup> ciclos de cambio / switching cycles
Frecuencia de cambio (AC15) / Switching frequency (AC15)	max. 3600 por hora / per hour

Ciclos de cambio Switching cycles	Tensión de operación / Rated operating voltage						
	24V	48V	110/127V	220/230V	380/400V	440V	600V
10 <sup>6</sup>	150VA	300VA	400VA	480VA	500VA	500VA	500VA
3x10 <sup>6</sup>	80VA	170VA	290VA	290VA	320VA	320VA	320VA
10 <sup>7</sup>	30VA	65VA	120VA	120VA	130VA	130VA	130VA

**Mini contactos auxiliares para CLZ1 / Mini auxiliary contacts for CLZ1**

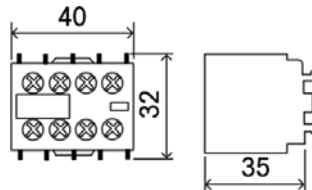

Referencia Reference	Contactos Contacts
CLZA-1A02	2 NC
CLZA-1A04	4 NC
CLZA-1A11	1 NO + 1 NC
CLZA-1A13	1 NO + 3 NC
CLZA-1A20	2 NO
CLZA-1A22	2 NO + 2 NC
CLZA-1A31	3 NO + 1 NC
CLZA-1A40	4 NO

CE UNE-EN 60947-5-1:2018

**Contactos auxiliares para CLZ2 / Auxiliary contacts for CLZ2**

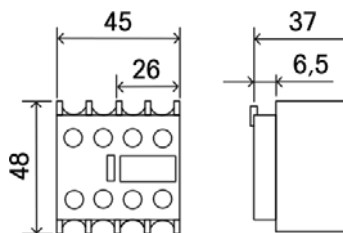

Referencia Reference	Contactos Contacts
CLZA-1B02	2 NC
CLZA-1B04	4 NC
CLZA-1B11	1 NO + 1 NC
CLZA-1B13	1 NO + 3 NC
CLZA-1B20	2 NO
CLZA-1B22	2 NO + 2 NC
CLZA-1B31	3 NO + 1 NC
CLZA-1B40	4 NO

CE UNE-EN 60947-5-1:2018

**CLZA - Accesorios para contactores / Accessories for contactors**

**Contacto auxiliar para contactor CLZ2 y CLZ3 / Auxiliary contact for contactor CLZ2 & CLZ3**

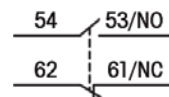
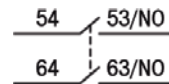
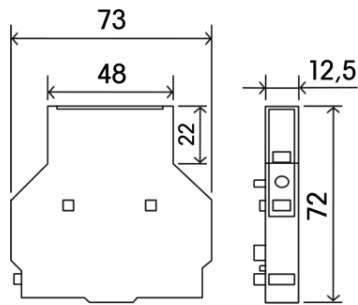

Referencia Reference	Contactos Contacts
CLZA-S1	2NO
CLZA-S2	1NO + 1NC

UNE-EN 60947-5-1:2018

**Temporizador para contactor— CLZ2 y CLZ3 / Timer for CLZ2 & CLZ3 contactor**



Referencia Reference	Contactos Contacts	Conmutación de retardo Switching delay
CLZA-T1	1NC + 1NO	0,1 - 30 s Retardo después de recogida / Delay after pick-up
CLZA-T2	1NC + 1NO	0,1 - 30 s Retardo después de liberación / Delay after release

UNE-EN 60947-5-1:2018

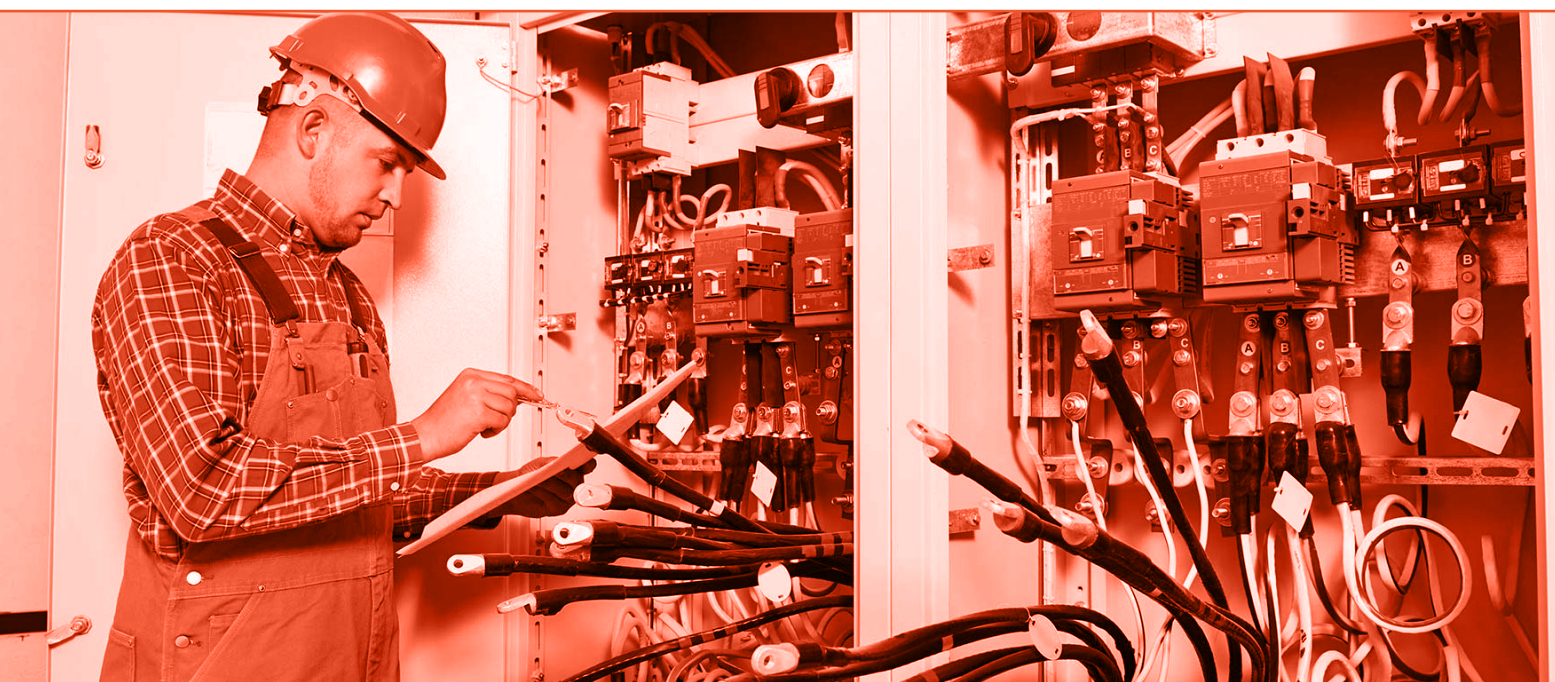

CLY1 - Relés térmicos electromecánicos / *Electromechanical thermal relays*

Referencia / Reference		CLY1-A	CLY1-B	CLY1-C
Tensión de aislamiento (V) Rated insulation voltage (V)		660 (690)		
Tensión de servicio Operating voltage		AC: 380V / DC: 220V		
Corriente térmica convencional (Ith A) Conventional thermal current (Ith A)		10		
Resistencia al impulso de tensión (kV) Rated impulse withstand voltage (kV)		6		
Intervalo de corriente ajustable (A) Adjustable current range (A)		0,1 - 25	23 - 40	23 - 80
Clase de aplicación Application class		AC15 - DC13		
Secciones de cables Terminal capacity	Sólido Solid	1,5 - 4	2,5 - 10	4 - 35
	Flexible Flexible	0,75 - 4	1,5 - 10	4 - 35
	Flexible con terminal Flexible with terminal	0,5 - 2,5	1 - 6	4 - 35
Temperatura de ambiente Ambient temperature	Operación normal Normal operation	-30°C...+55°C		
	Almacenaje Storage	-60°C...+70°C		
Grado de protección Protection degree		I.P.20		

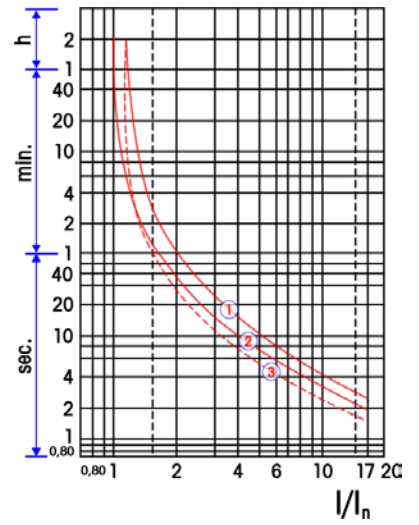

- 1 - Carga 3 fases, empezando en frío / 3 phase load, starting cold
- 2 - Carga 2 fases, empezando en frío / 2 phase load, starting cold
- 3 - Carga 3 fases, en estado caliente / 3 phase load, from warm state

CLY1-A (CLZ2-B...CLZ2-E)

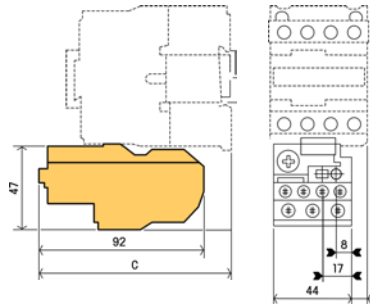

CLY1-B (CLZ2-F)

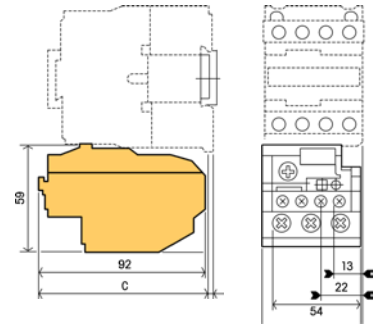

CLY1-C (CLZ2-G...CLZ2-L)

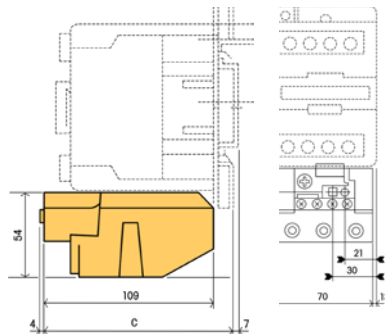

CLY1-C (CLZ2-M...CLZ2-N)

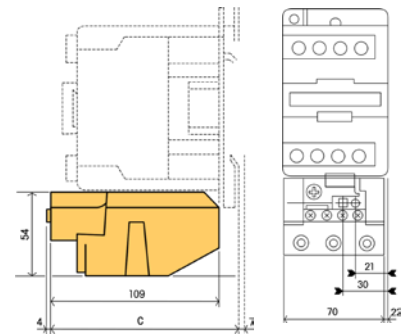

50/60Hz

UNE-EN IEC 60947-4-1:2021

**CLY1 - Relés térmicos electromecánicos / Electromechanical thermal relays**

Rango de regulación (A) Adjustment range (A)	Corriente térmica convencional (A) Conventional thermal current (A)	Tipo de contactor Type of contactor	Potencia Power					Referencias References	
			220V	380V	415V	440V	660V		
0,1 ~ 0,16	32	CLZ2-B...CLZ2-F	-	-	-	-	-	CLY1-A01	
0,16 ~ 0,25			-	-	-	-	-	CLY1-A02	
0,25 ~ 0,4			-	-	-	-	-	CLY1-A03	
0,4 ~ 0,63			-	-	-	-	0,37	CLY1-A04	
0,63 ~ 1			-	-	-	-	0,55	CLY1-A05	
1 ~ 1,3			-	0,37	-	0,55	0,75 1,1	CLY1-A06	
1,6 ~ 2,5			0,37	0,55 0,75	1,1	0,75 1,1	1,5	CLY1-A07	
2,5 ~ 4			0,55 0,75	1,1 1,5	1,1	1,5	3	CLY1-A08	
4 ~ 6			1,1	2,2	2,2	2,2	4	CLY1-A10	
5,5 ~ 8			1,5	3	3 3,7	3 3,7	5,5	CLY1-A12	
7 ~ 10			2,2	4	4	4	7,5	CLY1-A14	
10 ~ 13			3	5,5	5,5	5,5	10	CLY1-A16	
13 ~ 18			4	7,5	9	9	15	CLY1-A21	
18 ~ 25			5,5	11	11	11	18,5	CLY1-A22	
23 ~ 32	65	CLZ2-F	7,5	15	15	15	22	CLY1-B53	
28 ~ 36		10	18,5	22	22	30	CLY1-B55		
23 ~ 32		7,5	15	15	15	22	CLY1-C53		
30 ~ 40		10	18,5	22	22	30	CLY1-C55		
38 ~ 50		11	22	25	25	37	CLY1-C57		
48 ~ 57		15	25	30	30	45	CLY1-C59		
57 ~ 66		95	CLZ2-G...CLZ2-N	18,5	30	37	37	55	CLY1-C61
63 ~ 80				22	37	45	45	75	CLY1-C63

**CLY1-X - Adaptador para relé térmico / Adaptor for thermal relays**

Usando este adaptador, se puede instalar un relé térmico a un circuito de control sin el uso de un contactor. Los relés se pueden instalar en una placa de montaje o en carril EN50022.

By using this adaptor, relays can be installed into the control circuit without using a contactor. The relays are installable on a mounting plate or on a mounting rail EN50022.



CLY1-XA



CLY1-XB



CLY1-XC

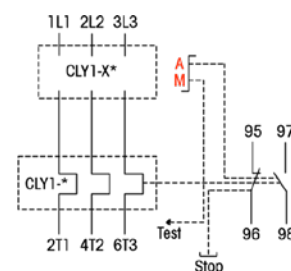
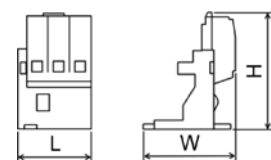

- 1 - Retorno automático / Automatic return
- 2 - Retorno manual / Manual return

Referencia Reference	Descripción Description	L x W x H (mm)
CLY1-XA	Adaptador para relés térmicos: CLY1-A Adaptor for thermal relays: CLY1-A	46 x 78 x 86
CLY1-XB	Adaptador para relés térmicos: CLY1-B Adaptor for thermal relays: CLY1-B	55 x 90 x 97
CLY1-XC	Adaptador para relés térmicos: CLY1-C Adaptor for thermal relays: CLY1-C	73 x 103 x 120

**CLX1 - Arrancadores directos en caja de pulsadores / Direct starters in push button case**

Referencia Reference		CLX1-09*	CLX1-12*	CLX1-18*	CLX1-25*	CLX1-32*	CLX1-40*	CLX1-50*	CLX1-65*	CLX1-80*	CLX1-95*
Corriente de empleo (A) Working current (A)	380V AC-3	9	12	18	25	32	40	50	65	80	95
	AC-4	3,5	5	7,7	8,5	12	18,5	24	28	32	45
Corriente nominal (A) / Nominal current (A)		25	25	32	40	50	60	80	80	125	125
Corriente máxima (A) Max. making current (A)	380V	90	120	180	250	320	400	500	650	800	950
	660V	108	144	216	300	384	430	600	780	960	1140
Corriente rotura máxima (A) Max. breaking current (A)	380V	72	96	114	200	256	320	400	520	640	760
	660V	90	120	180	250	320	400	500	650	800	960
Potencia de motor controlado (kw) Power of controlled motor (kw)	220V	2,2	3	4	5,5	7,5	11	15	18,5	22	25
	380V	4	5,5	7,5	11	15	18,5	22	30	37	45
	660V	5,5	7,5	7,5	15	18,5	30	33	37	45	45

\* Reemplazar con / Replace with: 1 = 24V, 2 = 36V, 3 = 48V, 4 = 110V, 5 = 220V, 6 = 380V

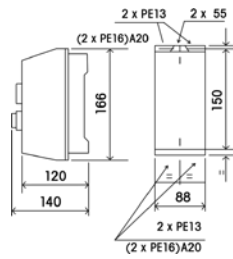
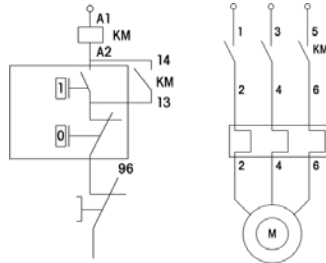

- CLX1-09\*
- CLX1-12\*
- CLX1-18\*

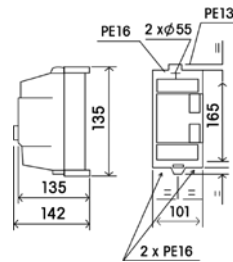

- CLX1-25\*
- CLX1-32\*

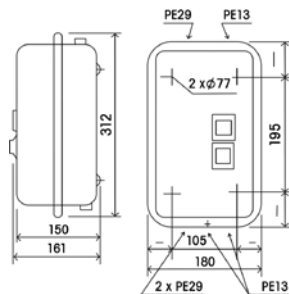

- CLX1-40\*
- CLX1-50\*
- CLX1-65\*
- CLX1-80\*
- CLX1-95\*



**CLX2 - Arranadores estrella - triángulo / Star - delta starters**

Características Técnicas / Technical characteristics:

Tensión de aislamiento (U <sub>i</sub> V) Isolation tension (U <sub>i</sub> V)	660	
Tensión de servicio (U <sub>e</sub> V) Operating voltage (U <sub>e</sub> V)	380	
Tensión nominal de circuito auxiliar (V) Rated operating voltage of auxiliary circuit (V)	380V AC, 220V DC	
Corriente del circuito auxiliar (A) Current of auxiliary circuit (A)	10	
Tensión de bobina (V) Coil voltage (V)	Arranque / Startup	85 - 110%
	Cierre / Release	20 - 75%

“Y” Arranque / Startup

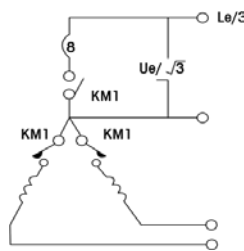

“Δ” Operación / Operating

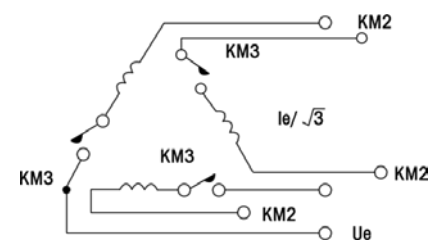

Referencia Reference	a max	b max
CLX2-01	144	140
CLX2-02	149	140
CLX2-03	160	170
CLX2-04	165	170

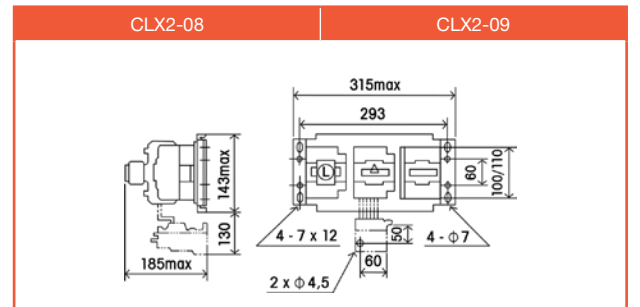
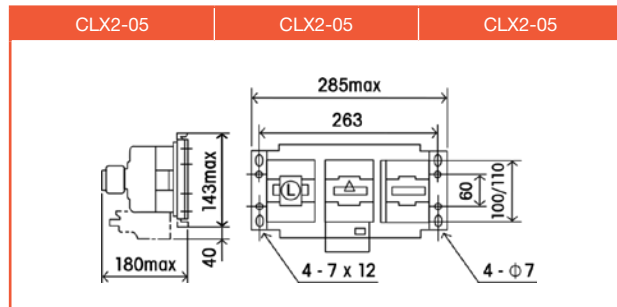
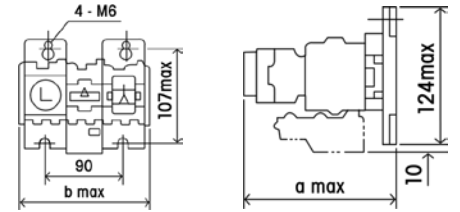

Referencia Reference	Contactores Contactors			Relé térmico Thermal relay		Potencia (kw) Power (kw)				Fusible (A) Fuse (A)	Corriente (Ie) Current (Ie) AC-3, 380V(A)	Vida eléctrica Electrical life AC-3, 380V
	Aislamiento Isolation	Y	Δ	Rango Range	Referencia Reference	220V	380V	415V	440V			
CLX2-01-*	CLZ2-C310	CLZ2-B301	CLZ2-C301	10~13	CLY1-A16	5,5	10	10	10	20	20	55 x 10 <sup>3</sup>
CLX2-02-*	CLZ2-D310	CLZ2-C301	CLZ2-D301	13~18	CLY1-A21	17,5	15	15	15	32	31	55 x 10 <sup>3</sup>
CLX2-03-*	CLZ2-E310	CLZ2-C301	CLZ2-E301	18~25	CLY1-A22	11	18,5	22	22	50	43	25 x 10 <sup>3</sup>
CLX2-04-*	CLZ2-F310	CLZ2-E301	CLZ2-F301	23~32	CLY1-A53	15	25	25	30	63	55	25 x 10 <sup>3</sup>
CLX2-05-*	CLZ2-G311	CLZ2-E301	CLZ2-G311	30~40	CLY1-A55	18,5	33	37	37	80	69	22,5 x 10 <sup>3</sup>
CLX2-06-*	CLZ2-H311	CLZ2-G311	CLZ2-H311	48~57	CLY1-A59	25	45	45	45	100	86	20 x 10 <sup>3</sup>
CLX2-07-*	CLZ2-I311	CLZ2-G311	CLZ2-I311	57~66	CLY1-A61	30	55	59	59	125	109	20 x 10 <sup>3</sup>
CLX2-08-*	CLZ2-J311	CLZ2-H311	CLZ2-J311	63~80	CLY1-A63	40	75	75	75	160	138	15 x 10 <sup>3</sup>
CLX2-09-*	CLZ2-K311	CLZ2-I311	CLZ2-K311	75~105	-	40	80	80	80	200	164	15 x 10 <sup>3</sup>

\* Reemplazar con / Replace with: 1 = 24V, 2 = 36V, 3 = 48V, 4 = 110V, 5 = 220V, 6 = 380V

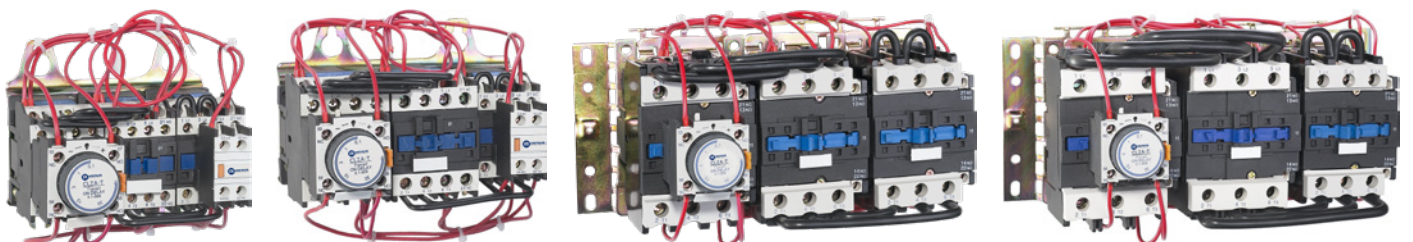

**CLW1 - Dispositivos para la protección de motores / Motor protection devices**

Características Técnicas / Technical characteristics:

Tensión de aislamiento <i>Rated insulating voltage</i>	690 V		Montaje <i>Mounting</i>	35x7,5mm Clip-on rail	
Tensión de servicio <i>Operating voltage</i>	660 V		Resistencia a impacto <i>Impact resistance</i>	30g	
Frecuencia de servicio <i>Rated oprating frequency</i>	50 / 60 Hz		Resistencia a vibraciones <i>Vibration resistance</i>	5g (5 - 150Hz)	
Consumo potencia <i>Power consumption</i>	max. 2,5 W		Peso <i>Weight</i>	0,25kg Approx.	
Vida mecánica & eléctrica <i>Mechanical &amp; electrical life</i>	10 <sup>5</sup> ciclos/cycles		Temperatura ambiente <i>Ambient temperature</i>	Almacenaje / <i>Storage</i>	40°C...+80°C
Frecuencia de maniobras <i>Switching frequency</i>	25 ciclos por hora / <i>cycles per hour</i>			Sin caja estanca / <i>Without enclosure</i>	-20°C...+60°C
Categoría de aplicación <i>Application category</i>	AC 3		Con caja estanca / <i>With enclosure</i>	-20°C...+40°C	
Grado de disparo del térmico <i>Breaking class of thermal breaker</i>	10 A		Bornes <i>Terminal capacity</i>	Sólido / <i>Solid</i>	2 x 1mm <sup>2</sup> ... 2 x 6mm <sup>2</sup>
Grado de protección <i>Protection grade</i>	Terminales / <i>Terminals</i>	IP20		Flexible / <i>Flexible</i>	2 x 1,5mm <sup>2</sup> ... 2 x 6mm <sup>2</sup>
	Instalado / <i>Installed</i>	IP40			
Con caja estanca / <i>With enclosure</i>		IP41 / IP55			

Rango de corriente ajustable <i>Adjustable current range</i> (A)	Potencia máxima de motor <i>Maximum motor power</i> (kW)	Interruptor magnético ajustable <i>Adjustable magnetic breaker</i> (A)	Fusible <i>Shunt fuse</i>		Referencia <i>Reference</i>
			aM (A)	gG (A)	
0,10 - 0,16	-	1,2	-	1	CLW1-01
0,16 - 0,25	0,06	2,4	-	1	CLW1-02
0,25 - 0,4	0,09	5	1	2	CLW1-03
0,4 - 0,63	0,18	8	1	2	CLW1-04
0,63 - 1	0,37	13	1	2	CLW1-05
1 - 1,6	0,55	22,5	2	4	CLW1-06
1,6 - 2,5	0,75	33,5	4	6	CLW1-07
2,5 - 4	1,5	51	6	10	CLW1-08
4 - 6,3	2,2	78	10	16	CLW1-10
6 - 10	4	138	10	20	CLW1-14
9 - 14	5,5	170	16	25	CLW1-16
13 - 18	7,5	223	20	32	CLW1-20
17 - 23	11	327	25	50	CLW1-21
20 - 25	11	327	25	50	CLW1-22
24 - 32	15	416	40	60	CLW1-32
25 - 40	22	480	40	80	CLW1-40
40 - 63	33	756	63	80	CLW1-63
56 - 80	45	960	80	80	CLW1-80

CLW1-01 ... CLW1-32

CLW1-40 ... CLW1-80

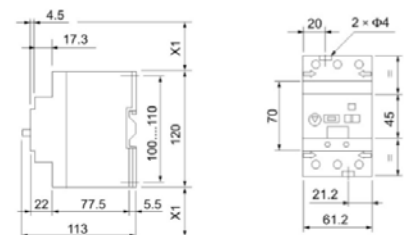
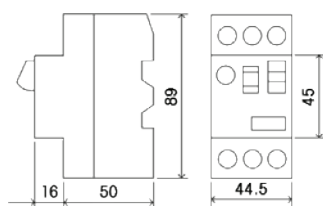

CLW1 - Dispositivos para la protección de motores / Motor protection devices

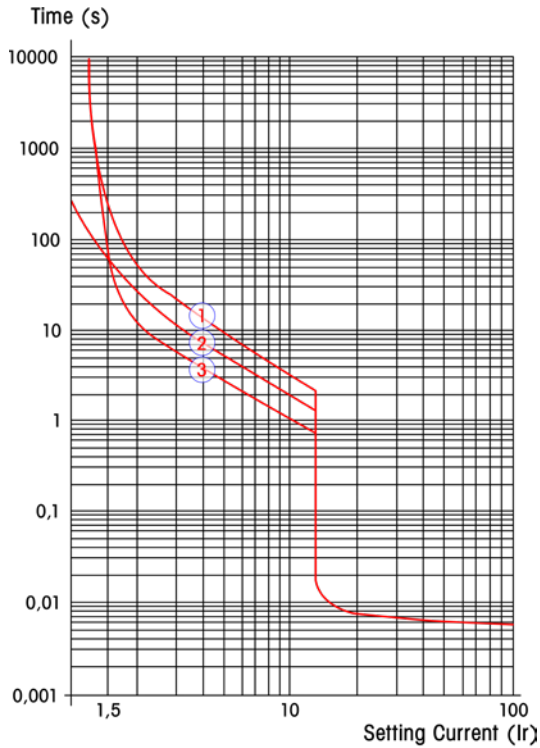

- 1 - 3 Polos arrancando en frío / 3 Poles, starting from cold state
- 2 - 2 Polos arrancando en frío / 2 Poles, starting from cold state
- 3 - 3 Polos arrancando en caliente / 3 Poles, starting from warm state

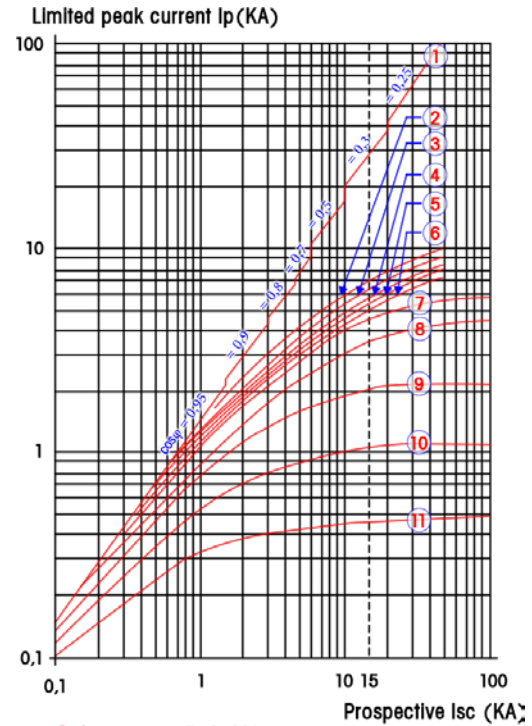

- 1 - Ip max
- 2 - 24 - 32A
- 3 - 20 - 25A
- 4 - 17 - 23A
- 5 - 13 - 18A
- 6 - 9 - 14A
- 7 - 6 - 10A
- 8 - 4-6, 3A
- 9 - 2,5 - 4A
- 10 - 1,6 - 2,5A
- 11 - 1 - 1,6A

Tensión de aislamiento / Rated insulating voltage		690 V
Poder de corte / Breaking capacity		1000 A
Tipo de fusible / Fuse type		gG (gL) 10A
Vida mecánica / Mechanical life		12,000 (Maniobras / Cycles)
Capacidad Terminales Terminal capacity	Sólido / Solid	1mm <sup>2</sup> - 2,5mm <sup>2</sup>
	Flexible / Flexible	0,75mm <sup>2</sup> - 2,5mm <sup>2</sup>
	Flexible con terminal / Flexible with cord-end terminal	0,75mm <sup>2</sup> - 1,5mm <sup>2</sup>
Consumo de potencia / Rated power consumption		max. 5 VA

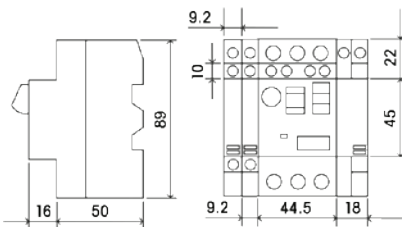

50/60Hz

UNE-EN 60947-2:2018  
UNE-EN 60947-5-1:2018

**CLW1-E - Contactos auxiliares frontales / Front auxiliary contacts**

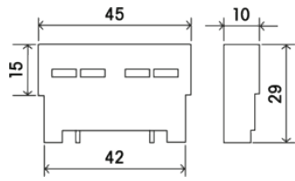

Tensión de servicio (V) Rated operating voltage (V)		24	48	60	230
Corriente en servicio (A) Rated operating current (A)	AC15	2	1,25	-	0,5
	DC13	1	0,3	0,15	-

**CLW1-E11**

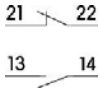

**CLW1-E20**

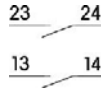

Referencia Reference	Contactos Contacts
CLW1-E11	1 contacto auxiliar abierto + 1 contacto auxiliar cerrado 1 open auxiliary contact + 1 closed auxiliary contact
CLW1-E20	2 contactos auxiliares cerrados 2 closed auxiliary contacts

CE UNE-EN 60947-5-1:2018

**CLW1-N - Contacto auxiliare lateral / Side auxiliary contact**

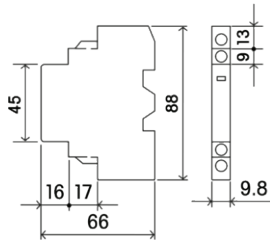

Tensión de servicio (V) Rated operating voltage (V)		24	48	60	230	400
Corriente en servicio (A) Rated operating current (A)	AC15	-	6	4,5	3	2
	DC13	6	6	1,3	0,5	-

**CLW1-N11**

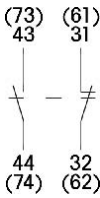

**CLW1-N20**

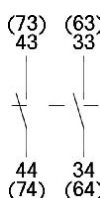

Referencia Reference	Contactos Contacts
CLW1-N11	1 contacto auxiliar abierto + 1 contacto auxiliar cerrado 1 open auxiliary contact + 1 closed auxiliary contact
CLW1-N20	2 contactos auxiliares abiertos 2 open auxiliary contacts

CE UNE-EN 60947-5-1:2018

**CLW1-M - Interruptor indicador de corto circuito / Short circuit breaking indicator**

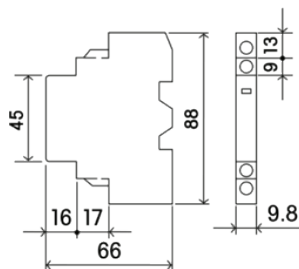

Tensión de servicio (V) Rated operating voltage (V)		24	48	60
Corriente en servicio (A) Rated operating current (A)	AC15	1,5	1	-
	DC13	1	0,3	0,15

**CLW1-M11**

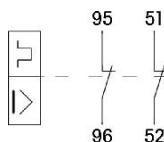

Referencia Reference	Contactos Contacts
CLW1-M11	1 contacto auxiliar de cambio 1 change-over auxiliary contact

CE UNE-EN 60947-5-1:2018

### CLW1-D - Interruptor indicador de sobrecarga / Overload breaking indicators

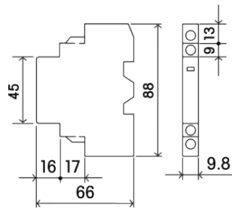

Referencia Reference	Contactos Contacts
CLW1-D1010	1 contacto cerrado + 1 contacto auxiliar cerrado 1 closed contact + 1 closed auxiliary contact
CLW1-D1001	1 contacto cerrado + 1 contacto auxiliar abierto 1 closed contact + 1 open auxiliary contact
CLW1-D0110	1 contacto abierto + 1 contacto auxiliar cerrado 1 open contact + 1 closed auxiliary contact
CLW1-D0101	1 contacto abierto + 1 contacto auxiliar abierto 1 open contact + 1 open auxiliary contact

CLW1-D1010	CLW1-D1001	CLW1-D0110	CLW1-D0101

Tensión de servicio (V) Rated operating voltage (V)		24	48	60	230	400
<b>Contacto Indicador / Indicator Contact</b>						
Corriente en servicio (A) Rated operating current (A)	AC15	2	1,25	-	0,5	-
	DC13	1	0,3	0,15	-	-
Corriente térmica / Thermal Current (A)		2,5	2,5	2,5	-	-
<b>Contacto Auxiliar / Auxiliary Contact</b>						
Corriente en servicio (A) Rated operating current (A)	AC15	-	6	-	3	2
	DC13	6	5	-	0,5	-
Corriente térmica / Thermal Current (A)		6	6	6	6	6

CE UNE-EN 60947-5-1:2018

### CLW1-U - Bobina de tensión mínima / Low voltage breaker

La bobina de tensión mínima actúa cuando la tensión cae por debajo del rango 35-70% de la tensión nominal. Cuando la tensión de servicio está por debajo del 35% de la nominal la bobina evita que el circuito cierre. Cuando la tensión de servicio es mayor del 85% de la tensión nominal garantiza el correcto funcionamiento del circuito.

The low voltage breaker trips when the operating voltage value falls below 35-70% of the rated value. When the operating voltage drops below 35% or the rated operating voltage, the coil does not allow the circuit to break. When the operating voltage is above 85% of the rated operating voltage it guarantees the correct functioning of the circuit.

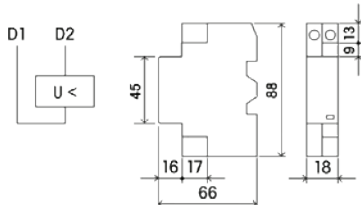

Referencia Reference	Tensión de servicio Rated operating voltage	Potencia Power
CLW1-U225	220 - 240 V AC	max. 5 VA
CLW1-U385	400 - 415 V AC	max. 5 VA

CE UNE-EN 60947-5-1:2018

### CLW1-S - Bobina de emisión de corriente / Working current breaker

La bobina de emisión de corriente actúa cuando recibe un impulso de tensión en un rango de 70 - 110% de la tensión nominal.

The working current breaker trips when the coils operating voltage value is between 70 - 110% of the rated operating voltage.

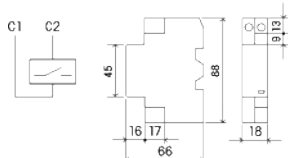

Referencia Reference	Tensión de servicio Rated operating voltage	Potencia Power
CLW1-S225	220 - 240 V AC	max. 5 VA
CLW1-S385	400 - 415 V AC	max. 5 VA

CE UNE-EN 60947-5-1:2018

### CLBOX\* - Cajas estancas / Sealed enclosures

Cajas estancas de material ABS. Ensayo con hilo incandescente a 650°C

ABS enclosures. Glow wire tested at 650°C.

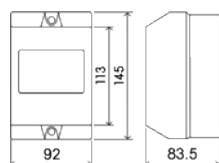

Referencia Reference	Protección IP IP protection	Potencia Power
CLBOX44	IP44	max. 5 VA
CLBOX55	IP55	max. 5 VA

CE UNE-EN 60947-5-1:2018



**CLZ2C - Bobinas para contactores / Coils for contactors**

Para contactores / For contactors: **CLZ2-B, CLZ2-C, CLZ2-D**

Tensión circuito controlado Control circuit voltage Uc (V)	50Hz			60Hz		
	Resistencia media Average resistance 20°C +/- 10% (Ω)	Inductancia circuito cerrado Inductance closed circuit (H)	Referencia Reference	Resistencia media Average resistance 20°C +/- 10% (Ω)	Inductancia circuito cerrado Inductance closed circuit (H)	Referencia Reference
24	6,82	0,3	CLZ2C-D2B5	5,45	0,25	CLZ2C-D2B6
36	12,26	0,48	CLZ2C-D2C5	-	-	-
48	28,05	1,22	CLZ2C-D2E5	22,09	1,02	CLZ2C-D2E6
110	148,2	5,7	CLZ2C-D2F5	116,6	4,5	CLZ2C-D2F6
220	-	-	-	490,2	18,5	CLZ2C-D2M6
230	649,7	25	CLZ2C-D2P5	-	-	-
240	726,6	25	CLZ2C-D2U5	587,4	21	CLZ2C-D2U6
380	-	-	-	1486	55	CLZ2C-D2Q6
415	2219	78	CLZ2C-D2N5	1826	69	CLZ2C-D2N6
440	2549	82	CLZ2C-D2R5	1892	71	CLZ2C-D2R6

**Consumo medio a 20°C / Average consumption at 20°C**

Corriente inrush / Inrush current: (cos θ = 0,75) 50Hz : 60VA, 60Hz : 70VA

Corriente aislada / Sealed current: (cos θ = 0,30) 50Hz : 7VA, 60Hz : 7,5VA

Rango de operación / Operating range: (0 ≤ 55°C) : 0,85 ... 1,10 Uc

Para contactores / For contactors: **CLZ2-B, CLZ2-C, CLZ2-D**

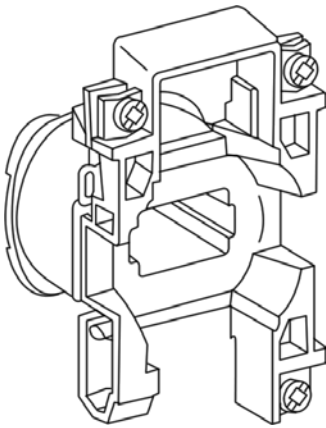

Tensión circuito controlado Control circuit voltage Uc (V)	50/60Hz		Referencia Reference
	Resistencia media Average resistance 20°C +/- 10% (Ω)	Inductancia circuito cerrado Inductance closed circuit (H)	
24	6,19	0,26	CLZ2C-D2B7
36	19,15	0,77	CLZ2C-D2D7
48	25	1,00	CLZ2C-D2E7
110	130	5,50	CLZ2C-D2F7
220/230	539	22	CLZ2C-D2M7
240	645	25	CLZ2C-D2U7
380	1580	60	CLZ2C-D2Q7
400	1938	74	CLZ2C-D2N7
440	2242	79	CLZ2C-D2R7

**Consumo medio a 20°C / Average consumption at 20°C**

Corriente inrush / Inrush current: (cos θ = 0,76) 50/60Hz : 70VA, 50Hz

Corriente aislada / Sealed current: (cos θ = 0,30) 50/60Hz : 8VA, 50Hz

Rango de operación / Operating range: (0 ≤ 55°C) : 0,85 ... 1,10 Uc

## CLZ2C - Bobinas para contactores / Coils for contactors

Para contactores / For contactors: **CLZ2-E, CLZ2-F**

Tensión circuito controlado Control circuit voltage Uc (V)	50Hz			60Hz		
	Resistencia media Average resistance 20°C +/- 10% (Ω)	Inductancia circuito cerrado Inductance closed circuit (H)	Referencia Reference	Resistencia media Average resistance 20°C +/- 10% (Ω)	Inductancia circuito cerrado Inductance closed circuit (H)	Referencia Reference
24	4,5	0,25	CLZ2C-D4B5	3,5	0,18	CLZ2C-D4B6
36	8,6	0,45	CLZ2C-D4C5	-	-	-
48	18,6	1,1	CLZ2C-D4E5	14,5	0,72	CLZ2C-D4E6
110	105	5,4	CLZ2C-D4F5	81	3,8	CLZ2C-D4F6
220	-	-	-	325	15	CLZ2C-D4M6
230	454	23	CLZ2C-D4P5	-	-	-
240	526	25	CLZ2C-D4U5	405	18	CLZ2C-D4U6
380	-	-	-	1010	30	CLZ2C-D4Q6
415	1595	76	CLZ2C-D4N5	-	-	-
440	1710	85	CLZ2C-D4R5	1315	61	CLZ2C-D4R6

### Consumo medio a 20°C / Average consumption at 20°C

Corriente inrush / Inrush current: (cos θ = 0,75) 50Hz : 90VA, 60Hz : 100VA

Corriente aislada / Sealed current: (cos θ = 0,30) 50Hz : 7,5VA, 60Hz : 8,5VA

Rango de operación / Operating range: (0 ≤ 55°C) : 0,80 ... 1,10 Uc

Para contactores / For contactors: **CLZ2-E, CLZ2-F**

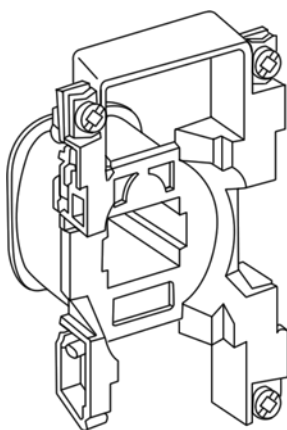

Tensión circuito controlado Control circuit voltage Uc (V)	50/60Hz		
	Resistencia media Average resistance 20°C +/- 10% (Ω)	Inductancia circuito cerrado Inductance closed circuit (H)	Referencia Reference
24	4,3	0,23	CLZ2C-D4B7
36	13,5	0,69	CLZ2C-D4D7
48	16	0,92	CLZ2C-D4E7
110	91	4,9	CLZ2C-D4F7
220	367	16	CLZ2C-D4M7
230	377	21	CLZ2C-D4P7
240	452	23	CLZ2C-D4U7
380	1186	32	CLZ2C-D4Q7
400	1383	70	CLZ2C-D4N7
440	1478	78	CLZ2C-D4R7

### Consumo medio a 20°C / Average consumption at 20°C

Corriente inrush / Inrush current: (cos θ = 0,75) 50/60Hz : 100VA, 50Hz

Corriente aislada / Sealed current: (cos θ = 0,30) 50/60Hz : 8,5VA, 50Hz

Rango de operación / Operating range: (0 ≤ 55°C) : 0,85 ... 1,10 Uc

**CLZ2C - Bobinas para contactores / Coils for contactors**

Para contactores / For contactors: **CLZ2-G, CLZ2-I, CLZ2-L, CLZ2-M, CLZ2-N**

Tensión circuito controlado Control circuit voltage Uc (V)	50Hz			60Hz		
	Resistencia media Average resistance 20°C +/- 10% (Ω)	Inductancia circuito cerrado Inductance closed circuit (H)	Referencia Reference	Resistencia media Average resistance 20°C +/- 10% (Ω)	Inductancia circuito cerrado Inductance closed circuit (H)	Referencia Reference
24	1,4	0,09	CLZ2C-D6B5	1,05	0,06	CLZ2C-D6B6
36	4,4	0,27	CLZ2C-D6D5	-	-	-
48	5,5	0,35	CLZ2C-D6E5	4,2	0,23	CLZ2C-D6E6
110	31	1,9	CLZ2C-D6F5	22	1,2	CLZ2C-D6F6
220	-	-	-	98	4,8	CLZ2C-D6M6
230	133	8,1	CLZ2C-D6P5	-	-	-
240	152	8,7	CLZ2C-D6U5	120	5,7	CLZ2C-D6U6
380	-	-	-	300	14	CLZ2C-D6Q6
415	463	26	CLZ2C-D6N5	-	-	-
440	513	30	CLZ2C-D6R5	392	19	CLZ2C-D6R6

**Consumo medio a 20°C / Average consumption at 20°C:**

Corriente inrush / Inrush current: (cos θ = 0,75) 50Hz : 200VA, 60Hz : 220VA

Corriente aislada / Sealed current: (cos θ = 0,30) 50Hz : 20VA, 60Hz : 22VA

Rango de operación / Operating range: (0 ≤ 55°C) : 0,80 ... 1,10 Uc

Para contactores / For contactors: **CLZ2-G, CLZ2-I, CLZ2-L, CLZ2-M, CLZ2-N**

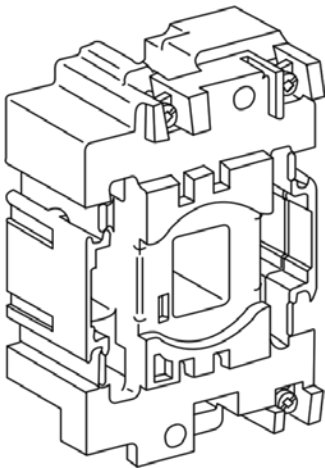

Tensión circuito controlado Control circuit voltage Uc (V)	50/60Hz		
	Resistencia media Average resistance 20°C +/- 10% (Ω)	Inductancia circuito cerrado Inductance closed circuit (H)	Referencia Reference
24	1,22	0,08	CLZ2C-D6B7
36	3,5	0,25	CLZ2C-D6D7
48	5	0,32	CLZ2C-D6E7
110	26	1,7	CLZ2C-D6F7
220	102	6,7	CLZ2C-D6M7
230	115	7,7	CLZ2C-D6P7
240	131	8,3	CLZ2C-D6U7
380	310	20	CLZ2C-D6Q7
415	390	24	CLZ2C-D6N7
440	410	27	CLZ2C-D6R7

**Consumo medio a 20°C / Average consumption at 20°C:**

Corriente inrush / Inrush current: (cos θ = 0,75) 50/60Hz : 245VA, 50Hz

Corriente aislada / Sealed current: (cos θ = 0,30) 50/60Hz : 26VA, 50Hz

Rango de operación / Operating range: (0 ≤ 55°C) : 0,85 ... 1,10 Uc

**CLZ3C - Bobinas para contactores / Coils for contactors**

Para contactores / For contactors: **CLZ3-O, CLZ3-Q**

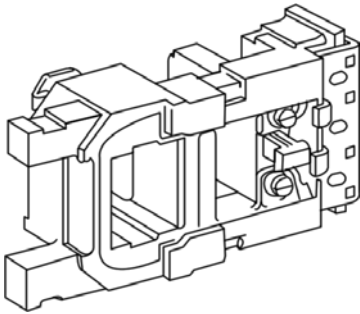

Tensión circuito controlado Control circuit voltage Uc		Resistencia media Average resistance 20°C +/- 10% (Ω)	Inductancia circuito cerrado Inductance closed circuit (H)	Código de voltaje Voltage code	Referencia Reference
50H	50Hz				
-	110	4,55	0,59	F6	CLZ3C-FF092
110	-	6,38	0,86	F5	CLZ3C-FF110
-	220	18,4	2,38	M6	CLZ3C-FF184
-	230/240	18,9	2,5	U6	CLZ3C-FF187
220/230	265/277	28,1	3,44	M5	CLZ3C-FF220
240	-	31,1	4,1	U5	CLZ3C-FF240
-	380	57,2	7,05	Q6	CLZ3C-FF316
-	415	67,9	8,21	N6	CLZ3C-FF340
-	440	72,6	9,21	R6	CLZ3C-FF360
380/400	460/480	86,9	10,3	Q5	CLZ3C-FF380
415/440	-	95,1	12	N5	CLZ3C-FF415

**Consumo medio a 20°C / Average consumption at 20°C:**

Corriente inrush / Inrush current: **50Hz : 550VA, 60Hz : 660VA**

Corriente aislada / Sealed current: **45VA; 60Hz : 55VA, cos θ = 0,32**

Ciclos de operación / Operating cycles: **(0 ≤ 55°C) : < 2400**

Para contactores / For contactors: **CLZ3-S, CLZ3-T**

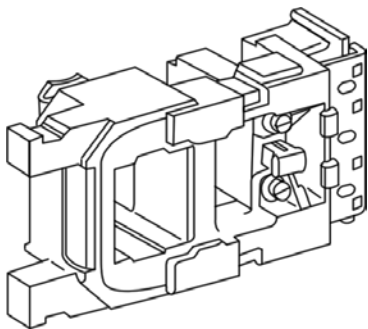

Tensión circuito controlado Control circuit voltage Uc		Resistencia media Average resistance 20°C +/- 10% (Ω)	Inductancia circuito cerrado Inductance closed circuit (H)	Código de voltaje Voltage code	Referencia Reference
50H	50Hz				
-	110	2,74	0,44	F6	CLZ3C-FG092
110	-	4,18	0,65	F5	CLZ3C-FG110
-	220	11,1	1,8	M6	CLZ3C-FG184
-	230/240	11,4	1,87	U6	CLZ3C-FG187
220/230	265/277	16,5	2,59	M5	CLZ3C-FG220
240	-	20,1	3,09	U5	CLZ3C-FG240
-	380	34	5,32	Q6	CLZ3C-FG316
-	415	40,8	6,2	N6	CLZ3C-FF340
-	440	43,5	6,94	R6	CLZ3C-FF360
380/400	460/480	51,3	7,75	Q5	CLZ3C-FF380
415/440	-	62,3	9,06	N5	CLZ3C-FF415

**Consumo medio a 20°C / Average consumption at 20°C:**

Corriente inrush / Inrush current: **50Hz : 805VA, 60Hz : 970VA**

Corriente aislada / Sealed current: **55VA; 60Hz : 66VA, cos θ = 0,34**

Ciclos de operación / Operating cycles: **(0 ≤ 55°C) : < 2400**

**CLZ3C - Bobinas para contactores / Coils for contactors**

Para contactores / For contactors: **CLZ3-U, CLZ3-V**

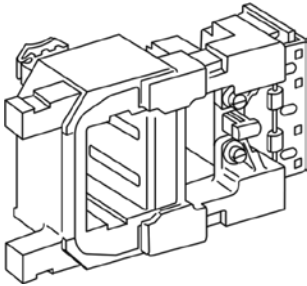

Tensión circuito controlado Uc Control circuit voltage Uc V	Resistencia media Average resistance 20°C +/- 10% (Ω)		Inductancia circuito cerrado Inductance closed circuit (H)	Código de voltaje Voltage code	Referencia Reference
	Irrupción inrush	Sellado Sealed			
110/115	18,7	415	1	F7	CLZ3C-FH1102
220/230	71,6	1621	1	M7	CLZ3C-FH2202
240	71,6	1621	1	U7	CLZ3C-FH2402
380/415	222	5075	1	Q7	CLZ3C-FH3802
480/500	345	7990	1	S7	CLZ3C-FH5002

**Consumo medio a 20°C / Average consumption at 20°C (50 o/or 60Hz, cos = φ0,9)**

Corriente inrush / Inrush current: **600...700 VA**

Corriente aislada / Sealed current: **8...10 VA**

Ciclos de operación / Operating cycles: **(0 ≤ 55°C) : 2400**

Para contactores / For contactors: **CLZ3-W**

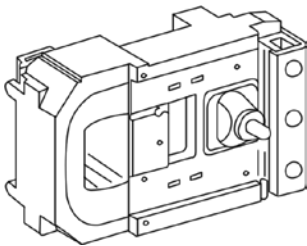

Tensión circuito controlado Uc Control circuit voltage Uc V	Resistencia media Average resistance 20°C +/- 10% (Ω)		Inductancia circuito cerrado Inductance closed circuit (H)	Código de voltaje Voltage code	Referencia Reference
	Irrupción inrush	Sellado Sealed			
110/115	18,7	415	1	F7	CLZ3C-FJ110
220/230	71,6	1621	1	M7	CLZ3C-FJ220
240	71,6	1621	1	U7	CLZ3C-FJ240
380/415	222	5075	1	Q7	CLZ3C-FJ380
480/500	345	7990	1	S7	CLZ3C-FJ500

**Consumo medio a 20°C / Average consumption at 20°C (50 o/or 60Hz, cos = φ0,9)**

Corriente inrush / Inrush current: **1000...1150 VA**

Corriente aislada / Sealed current: **12...18 VA**

Ciclos de operación / Operating cycles: **(0 ≤ 55°C) : 2400**

Para contactores / For contactors: **CLZ3-X**

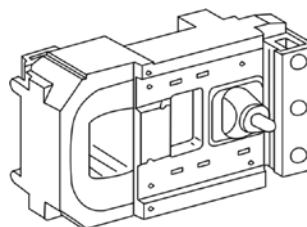

Tensión circuito controlado Uc Control circuit voltage Uc V	Resistencia media Average resistance 20°C +/- 10% (Ω)		Inductancia circuito cerrado Inductance closed circuit (H)	Código de voltaje Voltage code	Referencia Reference
	Irrupción inrush	Sellado Sealed			
110/115	18,7	415	1	F7	CLZ3C-FK110
220/230	71,6	1621	1	M7	CLZ3C-FK220
240	71,6	1621	1	U7	CLZ3C-FK240
380/415	222	5075	1	Q7	CLZ3C-FJ380
480/500	345	7990	1	S7	CLZ3C-FK500

**Consumo medio a 20°C / Average consumption at 20°C (50 o/or 60Hz, cos = φ0,9)**

Corriente inrush / Inrush current: **1050...1150 VA**

Corriente aislada / Sealed current: **16...20 VA**

Ciclos de operación / Operating cycles: **(0 ≤ 55°C) : 2400**



**CLZ3C - Bobinas para contactores / Coils for contactors**

Para contactores / For contactors: **CLZ3-Y**

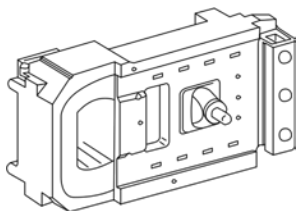

Tensión circuito controlado U <sub>c</sub> Control circuit voltage U <sub>c</sub> V	Resistencia media Average resistance 20°C +/- 10% (Ω)		Inductancia circuito cerrado Inductance closed circuit (H)	Código de voltaje Voltage code	Referencia Reference
	Irrupción Inrush	Sellado Sealed			
110/115	6,45	165	1,85	F7	CLZ3C-FL1102
220/230	25,5	730	3,35	M7	CLZ3C-FL2202
240	31	900	4,1	U7	CLZ3C-FL2402
380/415	96	2960	13	Q7	CLZ3C-FL3802
480/500	120	3660	16,5	S7	CLZ3C-FL5002

**Consumo medio a 20°C / Average consumption at 20°C (50 o/or 60Hz, cos = φ 0,9):**

Corriente inrush / Inrush current: **600...700 VA**

Corriente aislada / Sealed current: **8...10 VA**

Ciclos de operación / Operating cycles: **(0 ≤ 55°C) : 2400**

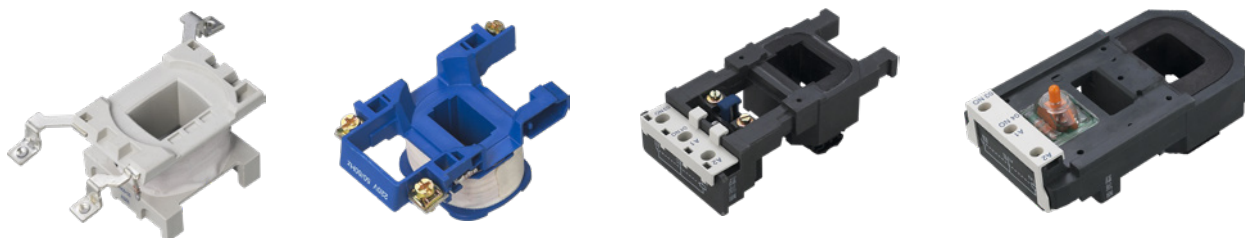

CE UNE-EN 60947-4-1

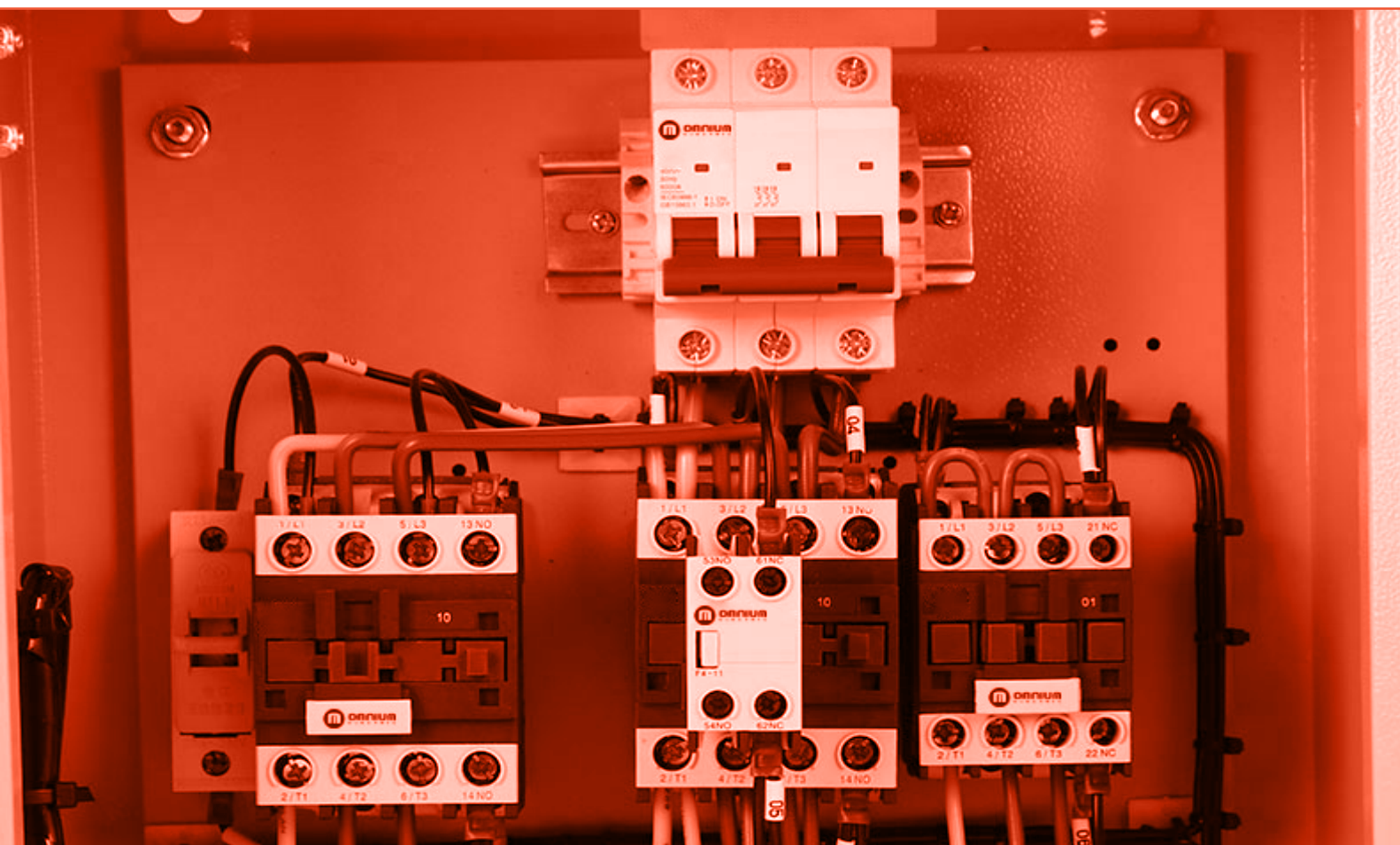

**CLV - Identificación de referencia y producto**  
**CLV - Product and reference identification**

CLV	Tipo Type		Tamaño Cuadro Frame Size		Polos Poles		Tensión Nominal Rated Current		Código de Corte Breaking Code	
	F	Fijo / Fixed		0125	125A	1	1 Polo / 1 Pole	0010	10A	B
A	Ajustable / Adjustable		0160	160A	2	2 Polos / 2 Poles	0013	12,5A	N	35kA
			0200	200A	3	3 Polos / 3 Poles	0016	16A	R	36kA
			0250	250A	4	4 Polos / 4 Poles	0020	20A	S	50kA
			0400	400			0025	25A	H	65kA
			0800	800A			0032	32A	G	85kA
			1600	1600A			0040	40A	C	100kA
							0050	50A		
							0063	63A		
							0080	80A		
							0100	100A		
							0125	125A		
							0160	160A		
							0200	200A		
							0250	250A		
							0315	315A		
							0400	400A		
							0500	500A		
							0630	630A		
							0800	800A		
							1000	1000A		
							1250	1250A		
							1600	1600A		

**Aplicación**

Los interruptores automáticos magnetotérmicos en caja moldeada de la serie CLV, con relés térmicos y magnéticos fijos, se usan principalmente en redes de distribución de 50/60Hz, con una tensión nominal de funcionamiento de hasta 690V y corrientes de hasta 2500A, para la distribución y protección de líneas y equipos contra daños por sobrecargas, cortocircuitos y cambios importantes del valor de la tensión de servicio (sobretensión o bajadas de tensión).

Esta serie también se puede usar para la protección de motores y los interruptores se pueden instalar en posición vertical o horizontal.

**Application**

CLV series moulded case circuit breakers, with fixed thermal and magnetic relays are used primarily in distribution networks of 50/60Hz, with a nominal working tension of up to 690V and currents of up to 2500A, for the distribution and protection of lines and equipment from damages caused by surges, shortcircuits or significant tension fluctuations.

This series can also be used for protecting motors and can be installed both vertically or horizontally.

CLVF0160-1\* - Interruptores magnetotérmicos en caja moldeada / Moulded case circuit breakers

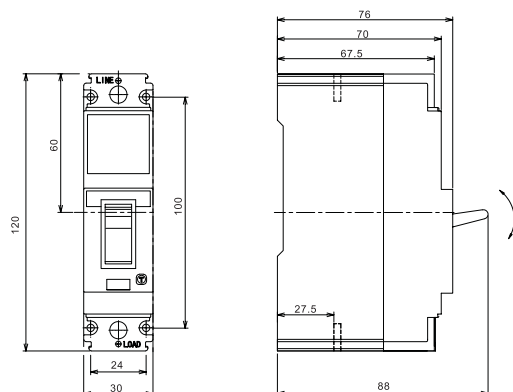

MODELO LIBERACIÓN FIJA / FIXED RELEASE MODEL		CLVF0160-1*		
Código de corte / Breaking capacity code		B	R	
Tipo / Frame Size - (Inm)		160A		
Corriente Nominal / Rated Current - (In 40, 50, 55°C)		12.5A, 16A, 20A, 25A, 32A, 40A, 50A, 63A, 80A, 100A, 125A, 160A		
Corriente nominal aislado / Rated insulated voltage - Ui(AC) 50/60Hz		500V		
Corriente nominal en operación / Rated operating voltage - Ue(AC) 50/60Hz		230V		
Polos / Poles		1P		
Capacidad nominal máxima de corte en cortocircuito / Rated ultimate short circuit breaking capacity - kA Icu AC400V/50Hz O-CO		25	36	
Capacidad nominal servicio de corte en operación / Rated service short circuit breaking capacity - kA Ics AC400V/50Hz O-CO-CO		18.75	27	
Capacidad nominal de corte en cortocircuito / Rated short circuit breaking capacity - Icm(pico/peak)/cos Φ AC400/50Hz O-CO		40/0.3	135/0.25	
Tensión nominal soportada al impulso / Rated impulse withstand voltage - Uimp		10000		
Propiedad diaeléctrica / Dielectric property		2500		
Distancia ionización / Ionization distance		<=30/0		
Resistencia / Endurance	Ciclos / Cycles	20000		
	Vida eléctrica / Electrical life	3000		
	Vida mecánica / Mechanical life	17000		
Disparo por sobrecorriente / Overcurrent Trip	Liberación térmica mecánica / Mechanical thermal release	-		
	Liberación ajustable magnético / Adjustable magnetic release	-		
	Tipo de liberación térmica y magnética fija / Fixed thermal and magnetic release type	✓		
Categoría / Category - (EN 60947-2 / IEC 60947-2)	Circuito Principal / Main Circuit	A/0		
	Circuito Auxiliar / Auxiliary Circuit	AC15		
Liberación de bajo voltaje / Under voltage release		-		
Liberación de derivación / Shunt release		-		
Contacto auxiliar / Auxiliary contact		-		
Contacto alarma / Alarm contact		-		
Contacto auxiliar y alarma / Auxiliary and alarm contact		-		
Mecanismo manejo de operación / Handle operation mechanism		-		
Mecanismo de operación eléctrica / Electrical operation mechanism		-		
Clips carril DIN / DIN rail clips		✓		
Tapa terminal / Terminal cover		-		
Separador de fases / Phase separator		-		
Mango de extensión / Extension handle		-		
Esquema de dimensiones / Dimensions outline		W	3P	30
			4P	-
		L	3P	120
			4P	-
		H	3P	70
			4P	-

**CLVF0200-2\* - Interruptores magnetotérmicos en caja moldeada / Moulded case circuit breakers**

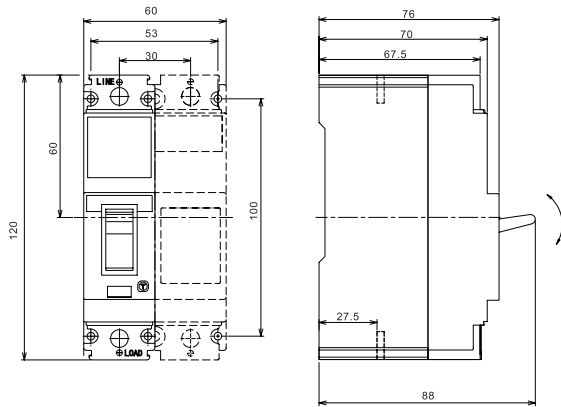

MODELO LIBERACIÓN FIJA / FIXED RELEASE MODEL		CLVF0200-2*		
Código de corte / Breaking capacity code		B	R	
Tipo / Frame Size - (Inm)		200A		
Corriente Nominal / Rated Current - (In 40, 50, 55°C)		16A, 20A, 25A, 32A, 40A, 50A, 63A, 80A, 100A, 125A, 160A, 200A		
Corriente nominal aislado / Rated insulated voltage - Ui(AC) 50/60Hz		750V		
Corriente nominal en operación / Rated operating voltage - Ue(AC) 50/60Hz		400V		
Polos / Poles		2P		
Capacidad nominal máxima de corte en cortocircuito / Rated ultimate short circuit breaking capacity - kA Icu AC400V/50Hz O-CO		25	36	
Capacidad nominal servicio de corte en operación / Rated service short circuit breaking capacity - kA Ics AC400V/50Hz O-CO-CO		18.75	27	
Capacidad nominal de corte en cortocircuito / Rated short circuit breaking capacity - Icm(pico/peak)/cos Φ AC400/50Hz O-CO		40/0.3		
Tensión nominal soportada al impulso / Rated impulse withstand voltage - Uimp		10000		
Propiedad diaeléctrica / Dielectric property		2500		
Distancia ionización / Ionization distance		<=30/0		
Resistencia / Endurance	Ciclos / Cycles	15000		
	Vida eléctrica / Electrical life	2500		
	Vida mecánica / Mechanical life	12500		
Disparo por sobrecorriente / Overcurrent Trip	Liberación térmica mecánica Mechanical thermal release	-		
	Liberación ajustable magnético Adjustable magnetic release	-		
	Tipo de liberación térmica y magnética fija Fixed thermal and magnetic release type	✓		
Categoría / Category - (EN 60947-2 / IEC 60947-2)	Circuito Principal / Main Circuit	A/0		
	Circuito Auxiliar / Auxiliary Circuit	AC15		
Liberación de bajo voltaje / Under voltage release		✓		
Liberación de derivación / Shunt release		✓		
Contacto auxiliar / Auxiliary contact		-		
Contacto alarma / Alarm contact		-		
Contacto auxiliar y alarma / Auxiliary and alarm contact		-		
Mecanismo manejo de operación / Handle operation mechanism		-		
Mecanismo de operación eléctrica / Electrical operation mechanism		-		
Clips carril DIN / DIN rail clips		✓		
Tapa terminal / Terminal cover		-		
Separador de fases / Phase separator		✓		
Mango de extensión / Extension handle		-		
Esquema de dimensiones / Dimensions outline		W	3P	60
			4P	-
		L	3P	120
			4P	-
		H	3P	70
			4P	-

CLVF0125\*- Interruptores magnetotérmicos en caja moldeable / Moulded case circuit breakers

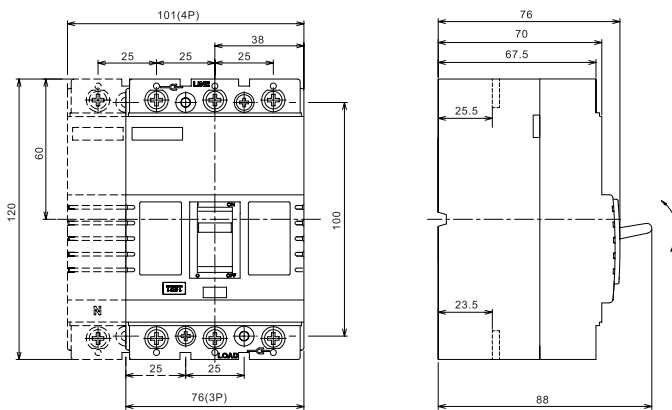

MODELO LIBERACIÓN FIJA / FIXED RELEASE MODEL		CLVF0125*		
Código de corte / Breaking capacity code		B	N	S
Tipo / Frame Size - (Inm)			125A	
Corriente Nominal / Rated Current - (In 40, 50, 55°C)		10A, 12.5A, 16A, 20A, 25A, 32(30)A, 40A, 50A, 63(60)A, 80A, 100A, 125A		
Corriente nominal aislado / Rated insulated voltage - Ui(AC) 50/60Hz			750V	
Corriente nominal en operación / Rated operating voltage - Ue(AC) 50/60Hz			400V	
Polos / Poles			3P / 4P	
Capacidad nominal máxima de corte en cortocircuito / Rated ultimate short circuit breaking capacity - kA Icu AC400V/50Hz O-CO		25	35	50
Capacidad nominal servicio de corte en operación / Rated service short circuit breaking capacity - kA Ics AC400V/50Hz O-CO-CO		12.5	17.5	37.5
Capacidad nominal de corte en cortocircuito / Rated short circuit breaking capacity - Icm(pico/peak)/cos Φ AC400/50Hz O-CO		40/0.3	73.5/0.25	105/0.25
Tensión nominal soportada al impulso / Rated impulse withstand voltage - Uimp			10000	
Propiedad dielectrica / Dielectric property			2500	
Distancia ionización / Ionization distance			<=30/0	
Resistencia / Endurance	Ciclos / Cycles		8000	
	Vida eléctrica / Electrical life		1000	
	Vida mecánica / Mechanical life		7000	
Disparo por sobrecorriente / Overcurrent Trip	Liberación térmica mecánica / Mechanical thermal release		-	
	Liberación ajustable magnético / Adjustable magnetic release		-	
	Tipo de liberación térmica y magnética fija / Fixed thermal and magnetic release type		✓	
Categoría / Category - (EN 60947-2 / IEC 60947-2)	Circuito Principal / Main Circuit		A/0	
	Circuito Auxiliar / Auxiliary Circuit		AC15	
Liberación de bajo voltaje / Under voltage release			✓	
Liberación de derivación / Shunt release			✓	
Contacto auxiliar / Auxiliary contact			✓	
Contacto alarma / Alarm contact			✓	
Contacto auxiliar y alarma / Auxiliary and alarm contact			✓	
Mecanismo manejo de operación / Handle operation mechanism			✓	
Mecanismo de operación eléctrica / Electrical operation mechanism			✓	
Clips carril DIN / DIN rail clips			✓	
Tapa terminal / Terminal cover			✓	
Separador de fases / Phase separator			✓	
Mango de extensión / Extension handle			-	
Esquema de dimensiones / Dimensions outline		W	3P	76
			4P	101
		L	3P	120
			4P	120
		H	3P	70
			4P	70



**CLVF160\* - Interruptores magnetotérmicos en caja moldeable / Moulded case circuit breakers**

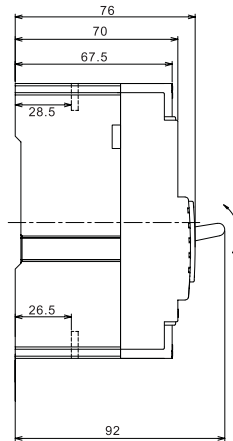
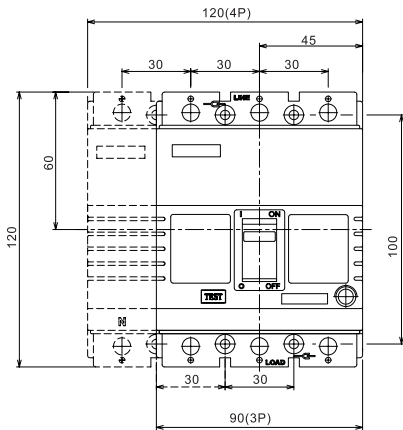

MODELO LIBERACIÓN FIJA / FIXED RELEASE MODEL		CLVF160*		
Código de corte / Breaking capacity code		B	N	S
Tipo / Frame Size - (Inm)			160A	
Corriente Nominal / Rated Current - (In 40, 50, 55°C)		10A, 12.5A, 16A, 20A, 25A, 32A, 40A, 50A, 63A, 80A, 100A, 125A, 160(150)A		
Corriente nominal aislado / Rated insulated voltage - Ui(AC) 50/60Hz		750V		
Corriente nominal en operación / Rated operating voltage - Ue(AC) 50/60Hz		400/415V		
Polos / Poles		3P / 4P		
Capacidad nominal máxima de corte en cortocircuito / Rated ultimate short circuit breaking capacity - kA Icu AC400V/50Hz O-CO		25	35	50
Capacidad nominal servicio de corte en operación / Rated service short circuit breaking capacity - kA Ics AC400V/50Hz O-CO-CO		12.5	26.25	37.5
Capacidad nominal de corte en cortocircuito / Rated short circuit breaking capacity - Icm(pico/peak)/cos Φ AC400/50Hz O-CO		41/0.3	75.5/0.25	110/0.25
Tensión nominal soportada al impulso / Rated impulse withstand voltage - Uimp		8000		
Propiedad dielectrica / Dielectric property		3000		
Distancia ionización / Ionization distance		<=30/0		
Resistencia / Endurance	Ciclos / Cycles	8000		
	Vida eléctrica / Electrical life	1000		
	Vida mecánica / Mechanical life	7000		
Disparo por sobrecorriente / Overcurrent Trip	Liberación térmica mecánica / Mechanical thermal release	Min: 0.8In - Max: 1In		
	Liberación ajustable magnético / Adjustable magnetic release	-		
	Tipo de liberación térmica y magnética fija / Fixed thermal and magnetic release type	✓		
Categoría / Category - (EN 60947-2 / IEC 60947-2)	Circuito Principal / Main Circuit	A/0		
	Circuito Auxiliar / Auxiliary Circuit	AC15		
Liberación de bajo voltaje / Under voltage release		✓		
Liberación de derivación / Shunt release		✓		
Contacto auxiliar / Auxiliary contact		✓		
Contacto alarma / Alarm contact		✓		
Contacto auxiliar y alarma / Auxiliary and alarm contact		✓		
Mecanismo manejo de operación / Handle operation mechanism		✓		
Mecanismo de operación eléctrica / Electrical operation mechanism		✓		
Clips carril DIN / DIN rail clips		✓		
Tapa terminal / Terminal cover		✓		
Separador de fases / Phase separator		✓		
Mango de extensión / Extension handle		-		
Esquema de dimensiones / Dimensions outline		W	3P	90
			4P	120
		L	3P	120
			4P	120
		H	3P	70
			4P	70

CLV0250\* - Interruptores magnetotérmicos en caja moldeada / Moulded case circuit breakers

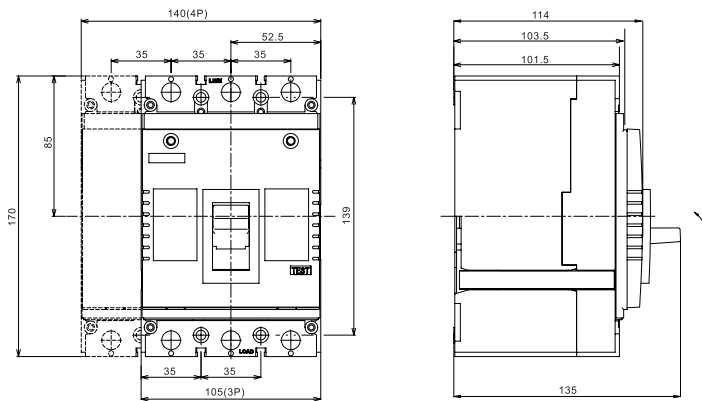

MODELO LIBERACIÓN FIJA / FIXED RELEASE MODEL		CLVF0250*			
Código de corte / Breaking capacity code		N	S	H	G
Tipo / Frame Size - (Inm)		250A			
Corriente Nominal / Rated Current - (In 40, 50, 55°C)		63A, 80A, 100A, 125A, 160A, 200(225)A, 250(320)A			
Corriente nominal aislado / Rated insulated voltage - Ui(AC) 50/60Hz		750V			
Corriente nominal en operación / Rated operating voltage - Ue(AC) 50/60Hz		400/415V			
Polos / Poles		3P / 4P			
Capacidad nominal máxima de corte en cortocircuito / Rated ultimate short circuit breaking capacity - kA Icu AC400V/50Hz O-CO		35	50	65	85
Capacidad nominal servicio de corte en operación / Rated service short circuit breaking capacity - kA Ics AC400V/50Hz O-CO-CO		26.25	37.5	48.75	51
Capacidad nominal de corte en cortocircuito / Rated short circuit breaking capacity - Icm(pico/peak)/cos Φ AC400/50Hz O-CO		77/0.25	114/0.25	143/0.2	178/0.2
Tensión nominal soportada al impulso / Rated impulse withstand voltage - Uimp		8000			
Propiedad dielectrica / Dielectric property		3000			
Distancia ionización / Ionization distance		<=30/0*			
Resistencia / Endurance	Ciclos / Cycles	8000			
	Vida eléctrica / Electrical life	1000			
	Vida mecánica / Mechanical life	7000			
Disparo por sobrecorriente / Overcurrent Trip	Liberación térmica mecánica / Mechanical thermal release	Min: 0.8In - Max: 1In			
	Liberación ajustable magnético / Adjustable magnetic release	-			
	Tipo de liberación térmica y magnética fija / Fixed thermal and magnetic release type	✓			
Categoría / Category - (EN 60947-2 / IEC 60947-2)	Circuito Principal / Main Circuit	A/B			
	Circuito Auxiliar / Auxiliary Circuit	AC15			
Liberación de bajo voltaje / Under voltage release		✓			
Liberación de derivación / Shunt release		✓			
Contacto auxiliar / Auxiliary contact		✓			
Contacto alarma / Alarm contact		✓			
Contacto auxiliar y alarma / Auxiliary and alarm contact		✓			
Mecanismo manejo de operación / Handle operation mechanism		✓			
Mecanismo de operación eléctrica / Electrical operation mechanism		✓			
Clips carril DIN / DIN rail clips		-			
Tapa terminal / Terminal cover		✓			
Separador de fases / Phase separator		✓			
Mango de extensión / Extension handle		-			
Esquema de dimensiones / Dimensions outline		W	3P	105	
			4P	140	
		L	3P	170	
			4P	170	
		H	3P	103.5	
			4P	103.5	

CLVF0400\* - Interruptores magnetotérmicos en caja moldeada / Moulded case circuit breakers

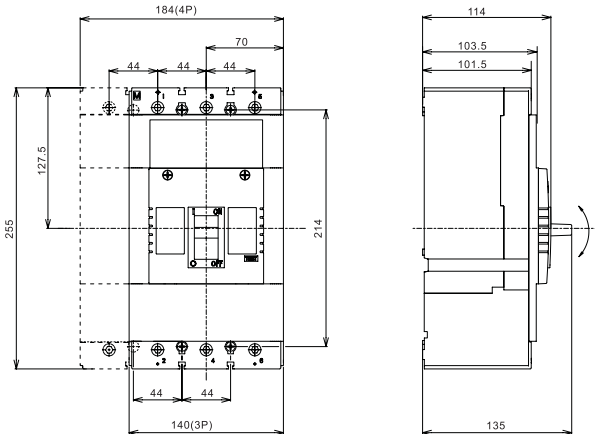

MODELO LIBERACIÓN FIJA / FIXED RELEASE MODEL		CLVF0400* (0630)			
Código de corte / Breaking capacity code		N	S	H	G
Tipo / Frame Size - (Inm)		400A			
Corriente Nominal / Rated Current - (In 40, 50, 55°C)		250A, 315(350)A, 400A, 500, 630A			
Corriente nominal aislado / Rated insulated voltage - Ui(AC) 50/60Hz		750V			
Corriente nominal en operación / Rated operating voltage - Ue(AC) 50/60Hz		400/415V			
Polos / Poles		3P / 4P			
Capacidad nominal máxima de corte en cortocircuito / Rated ultimate short circuit breaking capacity - kA Icu AC400V/50Hz O-CO		35	50	65	85
Capacidad nominal servicio de corte en operación / Rated service short circuit breaking capacity - kA Ics AC400V/50Hz O-CO-CO		26.25	37.5	52.5	52.5
Capacidad nominal de corte en cortocircuito / Rated short circuit breaking capacity - Icm(pico/peak)cos Φ AC400/50Hz O-CO		70/0.25	110/0.25	154/0.2	187/0.2
Tensión nominal soportada al impulso / Rated impulse withstand voltage - Uimp		8000			
Propiedad dielectrica / Dielectric property		3000			
Distancia ionización / Ionization distance		<=60/0*			
Resistencia / Endurance	Ciclos / Cycles	5000			
	Vida eléctrica / Electrical life	1000			
	Vida mecánica / Mechanical life	4000			
Disparo por sobrecorriente / Overcurrent Trip	Liberación térmica mecánica Mechanical thermal release	Min: 0.8In - Max: 1In			
	Liberación ajustable magnético Adjustable magnetic release	-			
	Tipo de liberación térmica y magnética fija Fixed thermal and magnetic release type	✓			
Categoría / Category - (EN 60947-2 / IEC 60947-2)	Circuito Principal / Main Circuit	A/B			
	Circuito Auxiliar / Auxiliary Circuit	AC15			
Liberación de bajo voltaje / Under voltage release		✓			
Liberación de derivación / Shunt release		✓			
Contacto auxiliar / Auxiliary contact		✓			
Contacto alarma / Alarm contact		✓			
Contacto auxiliar y alarma / Auxiliary and alarm contact		✓			
Mecanismo manejo de operación / Handle operation mechanism		✓			
Mecanismo de operación eléctrica / Electrical operation mechanism		✓			
Clips carril DIN / DIN rail clips		-			
Tapa terminal / Terminal cover		✓			
Separador de fases / Phase separator		✓			
Mango de extensión / Extension handle		✓			
Esquema de dimensiones / Dimensions outline		W	3P	140	
			4P	184	
		L	3P	255	
			4P	255	
		H	3P	103.5	
			4P	103.5	

CLVF0800\*- Interruptores magnetotérmicos en caja moldeada / Moulded case circuit breakers

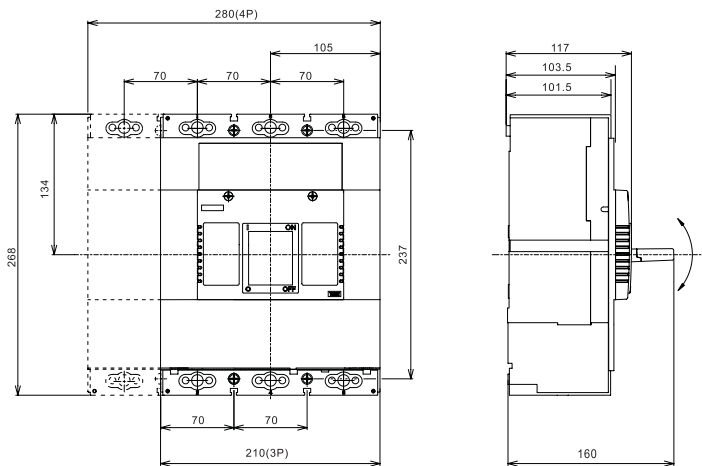

MODELO LIBERACIÓN FIJA / FIXED RELEASE MODEL		CLVF0800*			
Código de corte / Breaking capacity code		N	S	H	G
Tipo / Frame Size - (Inm)		800A			
Corriente Nominal / Rated Current - (In 40, 50, 55°C)		400A, 500A, 630(700)A, 800A, 1000A			
Corriente nominal aislado / Rated insulated voltage - Ui(AC) 50/60Hz		750V			
Corriente nominal en operación / Rated operating voltage - Ue(AC) 50/60Hz		400/415V			
Polos / Poles		3P / 4P			
Capacidad nominal máxima de corte en cortocircuito / Rated ultimate short circuit breaking capacity - kA Icu AC400V/50Hz O-CO		35	50	65	85
Capacidad nominal servicio de corte en operación / Rated service short circuit breaking capacity - kA Ics AC400V/50Hz O-CO-CO		26.25	37.5	52.5	52.5
Capacidad nominal de corte en cortocircuito / Rated short circuit breaking capacity - Icm(pico/peak)cos Φ AC400/50Hz O-CO		77/0.25	100/0.25	154/0.2	187/0.2
Tensión nominal soportada al impulso / Rated impulse withstand voltage - Uimp		8000			
Propiedad dieléctrica / Dielectric property		3000			
Distancia ionización / Ionization distance		<=80/0*			
Resistencia / Endurance	Ciclos / Cycles	5000			
	Vida eléctrica / Electrical life	1000			
	Vida mecánica / Mechanical life	4000			
Disparo por sobrecorriente / Overcurrent Trip	Liberación térmica mecánica Mechanical thermal release	Min: 0.8In - Max: 1In			
	Liberación ajustable magnético Adjustable magnetic release	-			
	Tipo de liberación térmica y magnética fija Fixed thermal and magnetic release type	✓			
Categoría / Category - (EN 60947-2 / IEC 60947-2)	Circuito Principal / Main Circuit	A/B			
	Circuito Auxiliar / Auxiliary Circuit	AC15			
Liberación de bajo voltaje / Under voltage release		✓			
Liberación de derivación / Shunt release		✓			
Contacto auxiliar / Auxiliary contact		✓			
Contacto alarma / Alarm contact		✓			
Contacto auxiliar y alarma / Auxiliary and alarm contact		✓			
Mecanismo manejo de operación / Handle operation mechanism		✓			
Mecanismo de operación eléctrica / Electrical operation mechanism		✓			
Clips carril DIN / DIN rail clips		-			
Tapa terminal / Terminal cover		✓			
Separador de fases / Phase separator		✓			
Mango de extensión / Extension handle		✓			
Esquema de dimensiones / Dimensions outline		W	3P	210	
		W	4P	280	
		L	3P	268	
		L	4P	268	
		H	3P	103.5	
		H	4P	103.5	

CLVF1600\* - Interruptores magnetotérmicos en caja moldeada / Moulded case circuit breakers

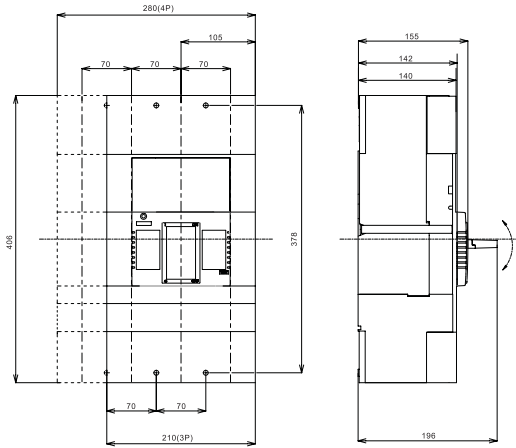

MODELO LIBERACIÓN FIJA / FIXED RELEASE MODEL		CLVF1600*		
Código de corte / Breaking capacity code		H	G	C
Tipo / Frame Size - (Inm)			1600A	
Corriente Nominal / Rated Current - (In 40, 50, 55°C)			800A, 1000A, 1250A, 1600A	
Corriente nominal aislado / Rated insulated voltage - Ui(AC) 50/60Hz			750V	
Corriente nominal en operación / Rated operating voltage - Ue(AC) 50/60Hz			400/415V	
Polos / Poles			3P / 4P	
Capacidad nominal máxima de corte en cortocircuito / Rated ultimate short circuit breaking capacity - kA Icu AC400V/50Hz O-CO	65		85	100
Capacidad nominal servicio de corte en operación / Rated service short circuit breaking capacity - kA Ics AC400V/50Hz O-CO-CO	50		50	50
Capacidad nominal de corte en cortocircuito / Rated short circuit breaking capacity - Icm(pico/peak)/cos Φ AC400/50Hz O-CO	105/0.25		143/0.2	
Tensión nominal soportada al impulso / Rated impulse withstand voltage - Uimp			8000	
Propiedad dielectrica / Dielectric property			3000	
Distancia ionización / Ionization distance			<=80/0*	
Resistencia / Endurance	Ciclos / Cycles		3000	
	Vida eléctrica / Electrical life		500	
	Vida mecánica / Mechanical life		2500	
Disparo por sobrecorriente / Overcurrent Trip	Liberación térmica mecánica / Mechanical thermal release		Min: 0.8In - Max: 1In	
	Liberación ajustable magnético / Adjustable magnetic release		-	
	Tipo de liberación térmica y magnética fija / Fixed thermal and magnetic release type		✓	
Categoría / Category - (EN 60947-2 / IEC 60947-2)	Circuito Principal / Main Circuit		A/B	
	Circuito Auxiliar / Auxiliary Circuit		AC15	
Liberación de bajo voltaje / Under voltage release			✓	
Liberación de derivación / Shunt release			✓	
Contacto auxiliar / Auxiliary contact			✓	
Contacto alarma / Alarm contact			✓	
Contacto auxiliar y alarma / Auxiliary and alarm contact			✓	
Mecanismo manejo de operación / Handle operation mechanism			✓	
Mecanismo de operación eléctrica / Electrical operation mechanism			✓	
Clips carril DIN / DIN rail clips			-	
Tapa terminal / Terminal cover			✓	
Separador de fases / Phase separator			✓	
Mango de extensión / Extension handle			✓	
Esquema de dimensiones / Dimensions outline		W	3P	210
			4P	280
		L	3P	406
			4P	406
		H	3P	138.5
			4P	138.5



CLVA0250\* - Interruptores magnetotérmicos en caja moldeada / Moulded case circuit breakers

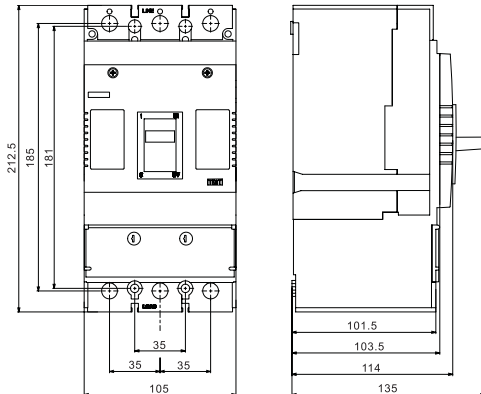

MODELO LIBERACIÓN AJUSTABLE / ADJUSTABLE RELEASE MODEL		CLVA0250*			
Código de corte / Breaking capacity code		N	S	H	G
Tipo / Frame Size - (Inm)		250A			
Corriente Nominal / Rated Current - (In 40, 50, 55°C)		125A, 160(180)A, 200(225)A, 250A, 320A			
Corriente nominal aislado / Rated insulated voltage - Ui(AC) 50/60Hz		750V			
Corriente nominal en operación / Rated operating voltage - Ue(AC) 50/60Hz		400/415V			
Polos / Poles		3P			
Capacidad nominal máxima de corte en cortocircuito / Rated ultimate short circuit breaking capacity - kA Icu AC400V/50Hz O-CO		35	50	65	85
Capacidad nominal servicio de corte en operación / Rated service short circuit breaking capacity - kA Ics AC400V/50Hz O-CO-CO		26.25	37.5	48.75	51
Capacidad nominal de corte en cortocircuito / Rated short circuit breaking capacity - Icm(pico/peak)/cos Φ AC400/50Hz O-CO		77/0.25	114/0.25	143/0.2	178/0.2
Tensión nominal soportada al impulso / Rated impulse withstand voltage - Uimp		8000			
Propiedad dielectrica / Dielectric property		3000			
Distancia ionización / Ionization distance		<=30/0*			
Resistencia / Endurance	Ciclos / Cycles	8000			
	Vida eléctrica / Electrical life	1000			
	Vida mecánica / Mechanical life	7000			
Disparo por sobrecorriente / Overcurrent Trip	Liberación térmica mecánica / Mechanical thermal release	Min: 0.7In - Max: 1In			
	Liberación ajustable magnético / Adjustable magnetic release	5In - 10In			
	Tipo de liberación térmica y magnética ajustable / Adjustable thermal and magnetic release type	✓			
Categoría / Category - (EN 60947-2 / IEC 60947-2)	Circuito Principal / Main Circuit	A/B			
	Circuito Auxiliar / Auxiliary Circuit	AC15			
Liberación de bajo voltaje / Under voltage release		✓			
Liberación de derivación / Shunt release		✓			
Contacto auxiliar / Auxiliary contact		✓			
Contacto alarma / Alarm contact		✓			
Contacto auxiliar y alarma / Auxiliary and alarm contact		✓			
Mecanismo manejo de operación / Handle operation mechanism		✓			
Mecanismo de operación eléctrica / Electrical operation mechanism		✓			
Clips carril DIN / DIN rail clips		-			
Tapa terminal / Terminal cover		✓			
Separador de fases / Phase separator		✓			
Mango de extensión / Extension handle		✓			
Esquema de dimensiones / Dimensions outline		W	3P	105	
			4P	-	
		L	3P	170	
			4P	-	
		H	3P	103.5	
			4P	-	

CLVA0400\* - Interruptores magnetotérmicos en caja moldeada / Moulded case circuit breakers

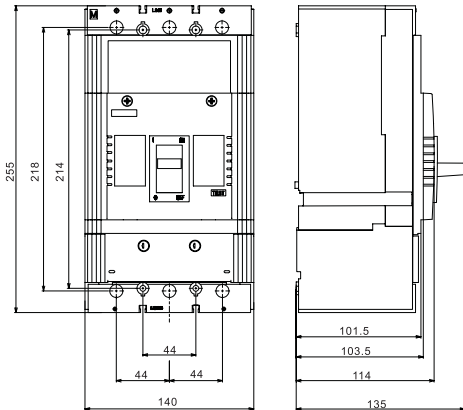

MODELO LIBERACIÓN AJUSTABLE / ADJUSTABLE RELEASE MODEL		CLVA0400* (0630)			
Código de corte / Breaking capacity code		N	S	H	G
Tipo / Frame Size - (Inm)		400A			
Corriente Nominal / Rated Current - (In 40, 50, 55°C)		250A, 315(350)A, 400A, 500A, 630A			
Corriente nominal aislado / Rated insulated voltage - Ui(AC) 50/60Hz		750V			
Corriente nominal en operación / Rated operating voltage - Ue(AC) 50/60Hz		400/415V			
Polos / Poles		3P / 4P			
Capacidad nominal máxima de corte en cortocircuito / Rated ultimate short circuit breaking capacity - Icu AC400V/50Hz O-CO		35	50	65	85
Capacidad nominal servicio de corte en operación / Rated service short circuit breaking capacity - Ics AC400V/50Hz O-CO-CO		26.25	37.5	52.5	52.5
Capacidad nominal de corte en cortocircuito / Rated short circuit breaking capacity - Icm(pico/peak)/cos Φ AC400/50Hz O-CO		70/0.251	10/0.25	154/0.2	187/0.2
Tensión nominal soportada al impulso / Rated impulse withstand voltage - Uimp		8000			
Propiedad dielectrica / Dielectric property		3000			
Distancia ionización / Ionization distance		<=60/0*			
Resistencia / Endurance	Ciclos / Cycles	5000			
	Vida eléctrica / Electrical life	1000			
	Vida mecánica / Mechanical life	4000			
Disparo por sobrecorriente / Overcurrent Trip	Liberación térmica mecánica / Mechanical thermal release	Min: 0.7In - Max: 1In			
	Liberación ajustable magnético / Adjustable magnetic release	5In - 10In			
	Tipo de liberación térmica y magnética ajustable / Adjustable thermal and magnetic release type	✓			
Categoría / Category - (EN 60947-2 / IEC 60947-2)	Circuito Principal / Main Circuit	A/B			
	Circuito Auxiliar / Auxiliary Circuit	AC15			
Liberación de bajo voltaje / Under voltage release		✓			
Liberación de derivación / Shunt release		✓			
Contacto auxiliar / Auxiliary contact		✓			
Contacto alarma / Alarm contact		✓			
Contacto auxiliar y alarma / Auxiliary and alarm contact		✓			
Mecanismo manejo de operación / Handle operation mechanism		✓			
Mecanismo de operación eléctrica / Electrical operation mechanism		✓			
Clips carril DIN / DIN rail clips		-			
Tapa terminal / Terminal cover		✓			
Separador de fases / Phase separator		✓			
Mango de extensión / Extension handle		✓			
Esquema de dimensiones / Dimensions outline		W	3P	140	
			4P	184	
		L	3P	255	
			4P	255	
		H	3P	103.5	
			4P	103.5	

CLVA0800\* - Interruptores magnetotérmicos en caja moldeada / Moulded case circuit breakers

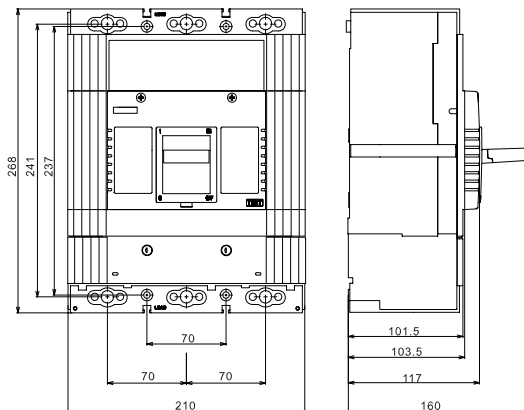

MODELO LIBERACIÓN AJUSTABLE / ADJUSTABLE RELEASE MODEL		CLVA0800*			
Código de corte / Breaking capacity code		N	S	H	G
Tipo / Frame Size - (Inm)		800A			
Corriente Nominal / Rated Current - (In 40, 50, 55°C)		400A, 500A, 630(700)A, 800A, 1000A			
Corriente nominal aislado / Rated insulated voltage - Ui(AC) 50/60Hz		750V			
Corriente nominal en operación / Rated operating voltage - Ue(AC) 50/60Hz		400/415V			
Polos / Poles		3P			
Capacidad nominal máxima de corte en cortocircuito / Rated ultimate short circuit breaking capacity - kA Icu AC400V/50Hz O-CO		35	50	65	85
Capacidad nominal servicio de corte en operación / Rated service short circuit breaking capacity - kA Ics AC400V/50Hz O-CO-CO		26.25	37.5	52.5	52.5
Capacidad nominal de corte en cortocircuito / Rated short circuit breaking capacity - Icm(pico/peak)/cos Φ AC400/50Hz O-CO		77/0.25	100/0.25	154/0.2	187/0.2
Tensión nominal soportada al impulso / Rated impulse withstand voltage - Uimp		8000			
Propiedad dielectrica / Dielectric property		3000			
Distancia ionización / Ionization distance		≤80/0*			
Resistencia / Endurance	Ciclos / Cycles	5000			
	Vida eléctrica / Electrical life	1000			
	Vida mecánica / Mechanical life	4000			
Disparo por sobrecorriente / Overcurrent Trip	Liberación térmica mecánica / Mechanical thermal release	Min: 0.7In - Max: 1In			
	Liberación ajustable magnético / Adjustable magnetic release	5In - 10In			
	Tipo de liberación térmica y magnética ajustable / Adjustable thermal and magnetic release type	✓			
Categoría / Category - (EN 60947-2 / IEC 60947-2)	Circuito Principal / Main Circuit	A/B			
	Circuito Auxiliar / Auxiliary Circuit	AC15			
Liberación de bajo voltaje / Under voltage release		✓			
Liberación de derivación / Shunt release		✓			
Contacto auxiliar / Auxiliary contact		✓			
Contacto alarma / Alarm contact		✓			
Contacto auxiliar y alarma / Auxiliary and alarm contact		✓			
Mecanismo manejo de operación / Handle operation mechanism		✓			
Mecanismo de operación eléctrica / Electrical operation mechanism		✓			
Clips carril DIN / DIN rail clips		-			
Tapa terminal / Terminal cover		✓			
Separador de fases / Phase separator		✓			
Mango de extensión / Extension handle		✓			
Esquema de dimensiones / Dimensions outline		W	3P	210	
		W	4P	-	
		L	3P	268	
		L	4P	-	
		H	3P	103.5	
		H	4P	-	

CLVA1600\* - Interruptores magnetotérmicos en caja moldeada / Moulded case circuit breakers

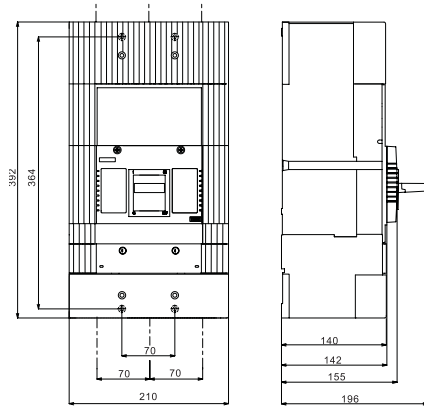

MODELO LIBERACIÓN AJUSTABLE / ADJUSTABLE RELEASE MODEL		CLVA1600*		
Código de corte / Breaking capacity code		H	G	C
Tipo / Frame Size - (Inm)		1600A		
Corriente Nominal / Rated Current - (In 40, 50, 55°C)		800A, 1000A, 1250A, 1600A		
Corriente nominal aislado / Rated insulated voltage - Ui(AC) 50/60Hz		750V		
Corriente nominal en operación / Rated operating voltage - Ue(AC) 50/60Hz		400/415V		
Polos / Poles		3P		
Capacidad nominal máxima de corte en cortocircuito / Rated ultimate short circuit breaking capacity - kA Icu AC400V/50Hz O-CO		65	85	100
Capacidad nominal servicio de corte en operación / Rated service short circuit breaking capacity - kA Ics AC400V/50Hz O-CO-CO		50	50	50
Capacidad nominal de corte en cortocircuito / Rated short circuit breaking capacity - Icm(pico/peak)/cos Φ AC400/50Hz O-CO		105/0.25	143/0.2	
Tensión nominal soportada al impulso / Rated impulse withstand voltage - Uimp		8000		
Propiedad dielectrica / Dielectric property		3000		
Distancia ionización / Ionization distance		<=80/0*		
Resistencia / Endurance	Ciclos / Cycles	3000		
	Vida eléctrica / Electrical life	500		
	Vida mecánica / Mechanical life	2500		
Disparo por sobrecorriente / Overcurrent Trip	Liberación térmica mecánica / Mechanical thermal release	Min: 0.7In - Max: 1In		
	Liberación ajustable magnético / Adjustable magnetic release	5In - 10In		
	Tipo de liberación térmica y magnética ajustable / Adjustable thermal and magnetic release type	✓		
Categoría / Category - (EN 60947-2 / IEC 60947-2)	Circuito Principal / Main Circuit	A/B		
	Circuito Auxiliar / Auxiliary Circuit	AC15		
Liberación de bajo voltaje / Under voltage release		✓		
Liberación de derivación / Shunt release		✓		
Contacto auxiliar / Auxiliary contact		✓		
Contacto alarma / Alarm contact		✓		
Contacto auxiliar y alarma / Auxiliary and alarm contact		✓		
Mecanismo manejo de operación / Handle operation mechanism		✓		
Mecanismo de operación eléctrica / Electrical operation mechanism		✓		
Clips carril DIN / DIN rail clips		-		
Tapa terminal / Terminal cover		✓		
Separador de fases / Phase separator		✓		
Mango de extensión / Extension handle		✓		
Esquema de dimensiones / Dimensions outline		W	3P	210
			4P	-
		L	3P	406
			4P	-
		H	3P	138.5
			4P	-

### CLV\* - Ventajas de Interruptores magnetotérmicos en caja moldeada / Advantages of MCCBs

- Los magnetotérmicos en caja moldeada evitan que los dispositivos eléctricos se dañen o se queden inutilizables debido a fallas en la red eléctrica.

- De tamaño compacto, tienen un efecto notable en el espacio de instalación y, a consecuencia, en el diseño del panel.

- Reducen significativamente los tiempos de reposición cuando se dispara por fallas.

- El mantenimiento general es gratuito y los costes de mantenimiento se reducen significativamente.

- Además de los MCCB, la gama omnicontrol ofrece accesorios que se pueden instalar en conjunto.

- MCCBs prevent electrical devices from being damaged or rendered useless due to faults.

- Compact in size, they have a notable effect on the installation space and in effect the panel design.

- Notably reduces reset times when tripped by faults.

- Overall upkeep is free and maintenance fees are significantly reduced.

- In addition to the MCCBs, the Omnicontrol range offers accessories that can be installed in conjunction.

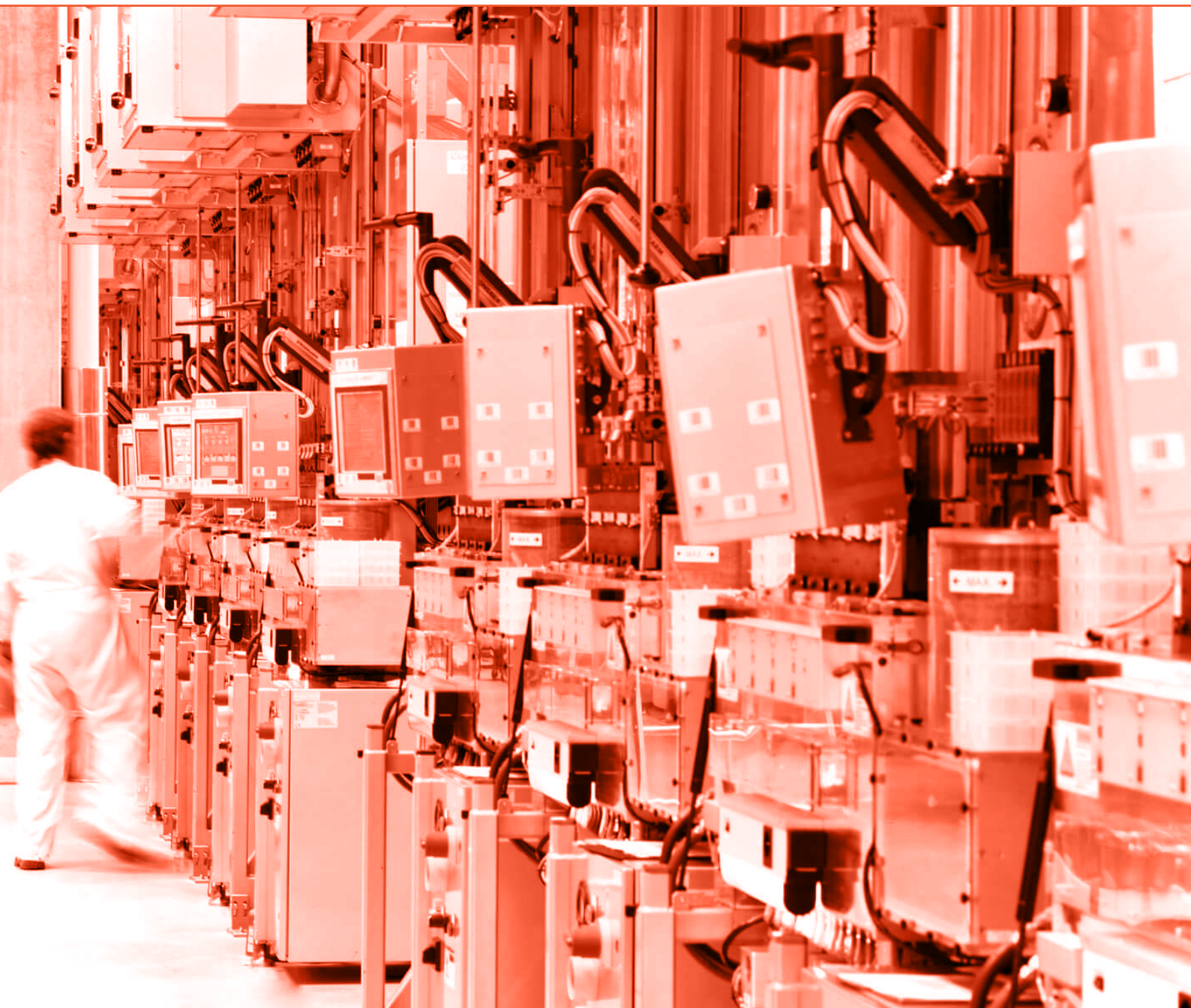



**CLV - Accesorios para Interruptores automáticos en caja moldeada / Accessories for MCCB's**

**CLVST\* - Bobina de disparo / Shunt tripper:**



Voltaje / Voltage	Tipo / Frame Size						
	63	100	225	400	630	800	1600
400V AC 50/60Hz	CLVST1-0063	CLVST1-0100	CLVST1-0225	CLVST1-0400	CLVST1-0630	CLVST1-0800	CLVST1-1600
230V AC 50/60Hz	CLVST2-0063	CLVST2-0100	CLVST2-0225	CLVST2-0400	CLVST2-0630	CLVST2-0800	CLVST2-1600
110V AC 50/60Hz	CLVST3-0063	CLVST3-0100	CLVST3-0225	CLVST3-0400	CLVST3-0630	CLVST3-0800	CLVST3-1600
230V DC	CLVST4-0063	CLVST4-0100	CLVST4-0225	CLVST4-0400	CLVST4-0630	CLVST4-0800	CLVST4-1600
110V DC	CLVST5-0063	CLVST5-0100	CLVST5-0225	CLVST5-0400	CLVST5-0630	CLVST5-0800	CLVST5-1600
24V DC	CLVST6-0063	CLVST6-0100	CLVST6-0225	CLVST6-0400	CLVST6-0630	CLVST6-0800	CLVST6-1600

**CLVUV\* - Bobina de subtensión / Under-voltage tripper:**



Voltaje / Voltage	Tipo / Frame Size						
	63	100	225	400	630	800	1600
400V AC 50/60Hz	CLVUV1-0063	CLVUV1-0100	CLVUV1-0225	CLVUV1-0400	CLVUV1-0630	CLVUV1-0800	CLVUV1-1600
230V AC 50/60Hz	CLVUV2-0063	CLVUV2-0100	CLVUV2-0225	CLVUV2-0400	CLVUV2-0630	CLVUV2-0800	CLVUV2-1600

**CLVAC\* - Contacto auxiliar / Auxiliary contact:**

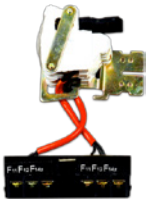

Contacto / Contact	Tipo / Frame Size						
	63	100	225	400	630	800	1600
1 X C/O	CLVAC1-0063	CLVAC1-0100	CLVAC1-0225	CLVAC1-0400	CLVAC1-0630	CLVAC1-0800	CLVAC1-1600
2 X C/O	-	-	-	CLVAC2-0400	CLVAC2-0630	CLVAC2-0800	CLVAC2-1600

**CLVAL1\* - Contacto alarma / Alarm contact:**

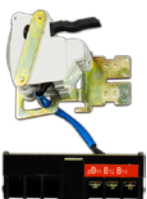

Contacto / Contact	Tipo / Frame Size						
	63	100	225	400	630	800	1600
1 X C/O	CLVAL1-0063	CLVAL1-0100	CLVAL1-0225	CLVAL1-0400	CLVAL1-0630	CLVAL1-0800	CLVAL1-1600

**CLV - Accesorios para Interruptores automáticos en caja moldeada / Accessories for MCCB's**

**CLVMA\* - Mecanismo de operación manual / Manual operating mechanism:**



Tipo / Type	Tipo / Frame Size						
	63	100	225	400	630	800	1600
F	CLVMA1-0063	CLVMA1-0100	CLVMA1-0225	CLVMA1-0400	CLVMA1-0630	CLVMA1-0800	CLVMA1-1600
A	CLVMA2-0063	CLVMA2-0100	CLVMA2-0225	CLVMA2-0400	CLVMA2-0630	CLVMA2-0800	CLVMA2-1600

**CLVMB\* - Mecanismo de operación motorizada / Motorised operating mechanism**



Voltaje / Voltage	Tipo / Frame Size						
	63	100	225	400	630	800	1600
400V AC 50/60Hz	CLVMB1-0063	CLVMB1-0100	CLVMB1-0225	CLVMB1-0400	CLVMB1-0630	CLVMB1-0800	CLVMB1-1600
230V AC 50/60Hz	CLVMB2-0063	CLVMB2-0100	CLVMB2-0225	CLVMB2-0400	CLVMB2-0630	CLVMB2-0800	CLVMB2-1600

**CLVRA\* - Adaptador de conexión trasero / Rear connection adaptor mechanism**



Polos / Poles	Tipo / Frame Size						
	63	100	225	400	630	800	1600
3	CLVRA1-0063	CLVRA1-0100	CLVRA1-0225	CLVRA1-0400	CLVRA1-0630	CLVRA1-0800	CLVRA1-1600
4	CLVRA2-0063	CLVRA2-0100	CLVRA2-0225	CLVRA2-0400	CLVRA2-0630	CLVRA2-0800	-

**CLVPI\* - Adaptador de conexión plug-in / Plug-in connection adaptor:**



Polos / Poles	Tipo / Frame Size						
	63	100	225	400	630	800	1600
3	CLVPI1-0063	CLVPI1-0100	CLVPI1-0225	CLVPI1-0400	CLVPI1-0630	CLVPI1-0800	CLVPI1-1600
4	CLVPI2-0063	CLVPI2-0100	CLVPI2-0225	CLVPI2-0400	CLVPI2-0630	CLVPI2-0800	-

**CLIS - Identificación de referencia y producto**  
**CLIS - Product and reference identification**

CLIS	Corriente Nominal Rated Current		Polos Poles		Tipo mando operación Operation handle type	
0100	100A		3	3P	E	Mango Exterior / Exterior Handle
0125	125A		4	4P	I	Mango Interior / Interior Handle
0160	160A					
0200	200A					
0250	250A					
0315	315A					
0400	400A					
0500	500A					
0630	630A					
1000	1000A					
1250	1250A					

- **Altitud de instalación / Installation altitude**  $\leq 200\text{mm}$
- **Rango de temperatura ambiente / Ambient temperature range:**  $-5^{\circ}\text{C} \sim 40^{\circ}\text{C}$
- **Humedad relativa / Relative humidity:**  $\leq 95\%$
- **No debe exponerse a ningun medio explosivo / Must not be exposed to any explosive medium**
- **No debe exponerse a lluvia ni nieve / Must not be exposed to rain or snow**



CLIS - Interruptor de aislamiento de carga / Load isolation switch

<b>Corriente de calefacción convencional (Ith A)</b> Conventional heating current(Ith A)		40A	63A	80A	100A	125A	160A	200A	250A	315A	400A	500A	630A	1000A	1250A	1600A	2000A	2500A	3150A		
<b>Tensión nominal de aislamiento (Ui V)</b> Rated insulation voltage (Ui V)		40	63	80	100	750	750	750	750	1000	1000	1000	1000	1000	1000	1000	1000	1000	1000	1000	
<b>Resistencia dieléctrica (V)</b> Dielectric strength (V)		5000	5000	5000	5000	5000	5000	5000	5000	8000	8000	8000	8000	10000	10000	10000	10000	10000	10000		
<b>Tensión nominal soportada de impacto Uimp KV (Tipo de instalación IV)</b> Rated impact withstand voltage Uimp KV (Installation sort IV)		6	6	6	6	8	8	8	8	12	12	12	12	12	12	12	12	12	12		
	<b>400V</b>	<b>AC21B</b>	40	63	80	100	125	160	200	250	315	400	500	630	1000	1250	1600	2000	2500	3150	
		<b>AC22B</b>	40	63	80	100	125	160	200	250	315	400	500	630	1000	1250	1600	2000	2500	2500	
		<b>AC23B</b>	40	63	80	100	125	160	200	250	315	400	425	500	800	1000	1250	1250	1250	1250	
	<b>750V</b>	<b>DC21</b>	40	63	80	100	125	160	160	200	315	400	400	500	1000	1000	1600	2000	2500	3150	
		<b>DC22</b>	40	63	80	100	125	160	160	160	315	315	315	315	800	800	800	2000	2000	2000	
		<b>DC23</b>	20	20	40	50	80	80	100	125	125	125	125	125	400	400	500	1000	1000	1000	
	<b>220V</b>	<b>AC21B</b>	40	63	80	100	125	160	200	250	315	400	500	630	-	-	-	-	-	-	
		<b>AC22B</b>	40	63	80	100	125	160	200	250	315	400	400	500	-	-	-	-	-	-	
		<b>AC23B</b>	35	50	65	80	125	125	160	200	-	-	-	-	-	-	-	-	-	-	
	<b>440V</b>	<b>DC21</b>	35	50	65	80	100	125	160	200	315	400	400	500	-	-	-	-	-	-	
		<b>DC22</b>	35	50	65	80	100	125	160	200	315	400	400	500	-	-	-	-	-	-	
		<b>DC23</b>	35	50	65	80	100	125	160	200	-	-	-	-	-	-	-	-	-	-	
<b>Potencia Motor P(kW)</b> Motor Power P(kW)		<b>400V</b>		25	35	45	55	63	80	100	132	160	220	280	315	560	560	560	710	710	710
		<b>750V</b>		20	30	40	45	75	75	90	110	185	185	185	185	475	475	475	750	750	750
<b>Corriente nominal soportada a corto plazo (Icw (kA Rms) 0.1S / 1.0S)</b> Rated short term withstand current (Icw(kA Rms) 0.1S/1.0S)		0.756	0.756	1.2	1.2	20/10	20/10	30/12	30/12	45/20	45/20	50/25	50/25	90/50	90/50	90/50	90/50	90/50	90/50	90/50	
<b>Capacidad de realización nominal Icn (A Rms) AC23B 400V</b> Nominal making capacity Icn (A Rms) AC23B 400V		400	640	800	1000	1250	1250	2000	2000	3150	4000	4000	4000	10000	10000	10000	10000	10000	10000	10000	
<b>Capacidad de corte nominal Icm (A Rms) AC23B 400V</b> Nominal making capacity Icm (A Rms) AC23B 400V		320	504	640	800	1000	1000	1600	1600	2500	3200	3200	3200	8000	8000	8000	8000	8000	8000	8000	
<b>Capacidad nominal de cortocircuito Icm (KA) valor pico</b> Rated short circuit making capacity Icm (KA peak value)		1.066	1.066	1.7	1.7	12	12	17	17	30	30	40	40	70	70	70	70	70	70	70	
<b>Vida mecánica (Tiempo de operación de rotación)</b> Mechanical life (Rotation operation time)		10000	10000	10000	10000	10000	10000	10000	10000	5500	5500	5500	5500	4000	4000	3000	2500	2500	2500	2500	
<b>Vida eléctrica (Tiempo operación de rotación)</b> Voltage nominal Ue = 750V <b>Corriente nominal (Ie)</b> Electrical life (Rotation operation time) Rated voltage Ue = 750V Rated current (Ie)		cos φ=95 AC21B	3000	3000	3000	3000	1500	1500	1500	1500	750	750	750	750	600	600	450	400	400	350	
		cos φ=65 AC22B	2000	2000	2000	2000	1000	1000	1000	1000	500	500	500	500	400	400	300	200	200	200	
		cos φ=35 AC23B	1000	1000	1000	1000	500	500	500	500	250	250	250	250	200	200	150	100	100	100	
<b>Par de operación (Nm)</b> Operation torque (Nm)		0,41	0,41	0,41	0,41	1,5	1,5	2,5	2,5	4	4	4,5	4,5	13	13	20	40	40	49	49	

CLIS - Interruptor de aislamiento de carga / Load isolation switch

40-63A Dimensiones frontales directa / Front direct operation

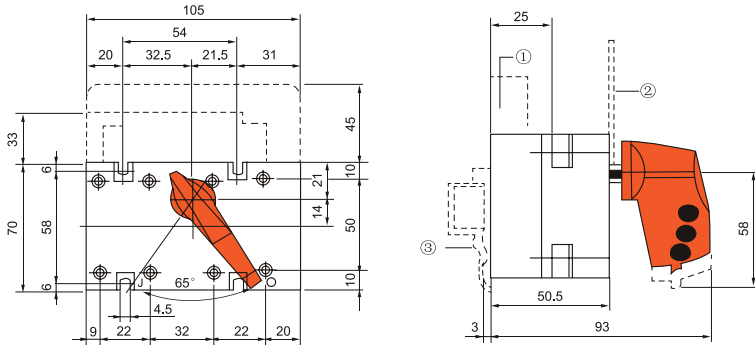

Operación frontal externo  
Front external direct operation

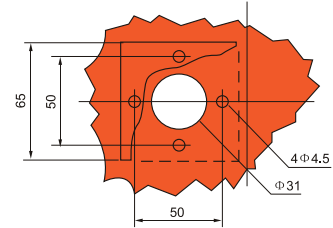

80-100A Operación frontal directa / Front direct operation

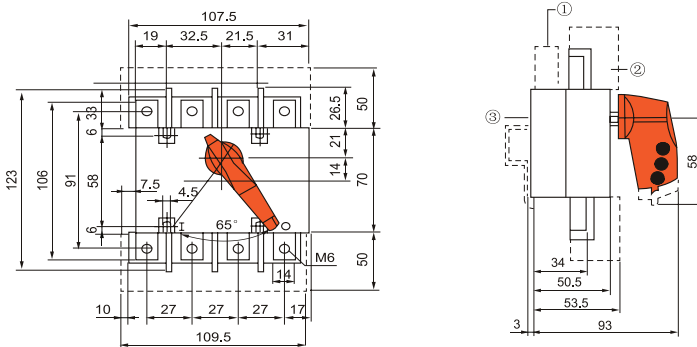

Operación frontal externo  
Front external direct operation

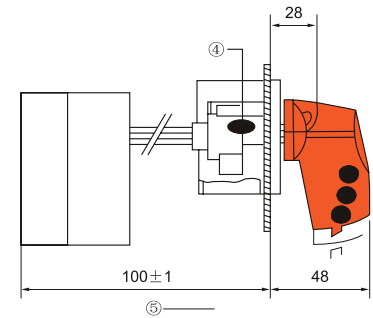

125-630A Operación frontal directa / Front direct operation

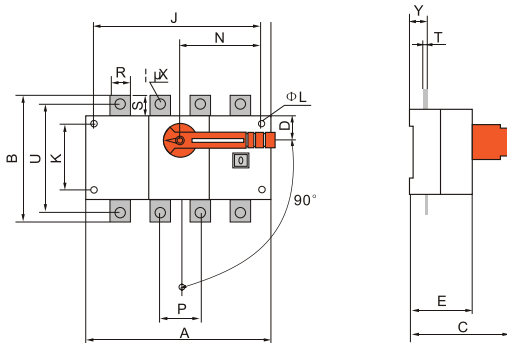

Instalación manilla y placa inferior ext.  
Ext. handle and bottom plate installation

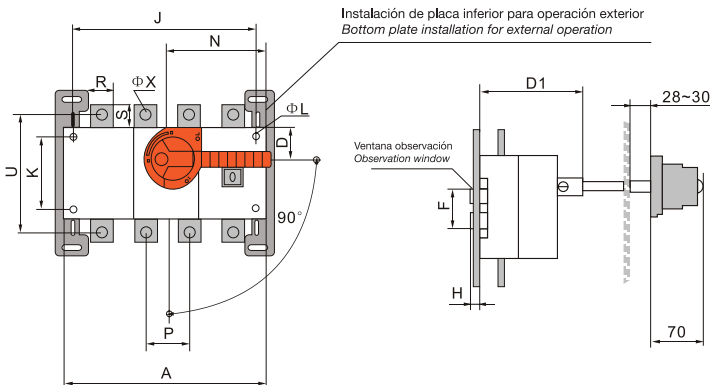
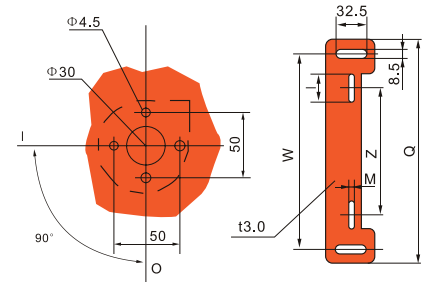

Dimensiones del cuadro inferior / Dimensions of bottom board

Referencia	I	M	Z	W	Q
CLIS0125*	55	5.5	85	190	218
CLIS0160*	55	5.5	85	190	218
CLIS0200*	55	5.5	85	190	218
CLIS0250*	55	5.5	85	190	218
CLIS0315*	60	6.5	130	240	270
CLIS0400*	60	6.5	130	240	270
CLIS0500*	60	6.5	130	240	270
CLIS0630*	60	6.5	130	240	270



**CLIS - Interruptor de aislamiento de carga / Load isolation switch**

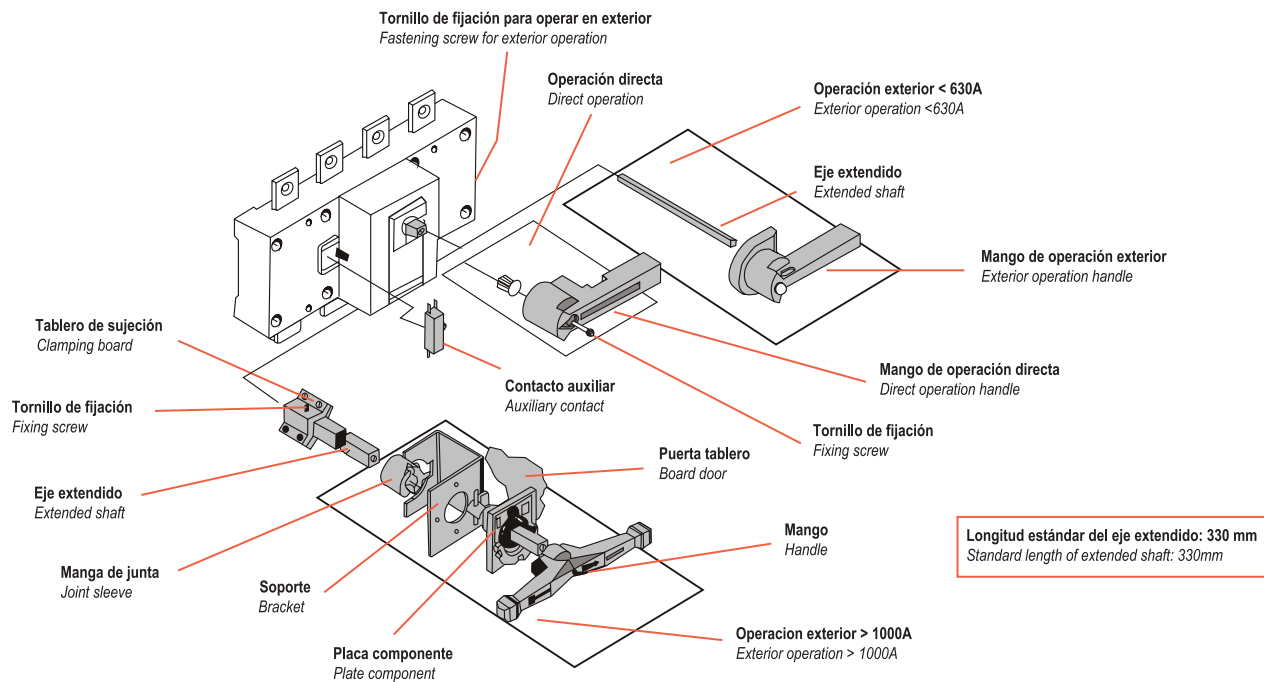

UNE EN IEC 60947-1

**DIMENSIONES EXTERNAS Y DE INSTALACIÓN / EXTERNAL PRODUCT AND INSTALLATION DIMENSIONS**

REFERENCIA	A	B	C	D	D1	E	øL	J	K	N	P	R	S	T	U	øX	Y	F	H
CLIS01253*	140	135	120	27	93	73	5.5	120	65	85	36	20	25	3	114	10	24	49	10
CLIS01254*	170	135	120	27	93	73	5.5	150	65	85	36	20	25	3	114	10	24	49	10
CLIS01603*	140	135	120	27	93	73	5.5	120	65	85	36	20	25	3	114	10	24	49	10
CLIS01604*	170	135	120	27	93	73	5.5	150	65	85	36	20	25	3	114	10	24	49	10
CLIS02003*	180	165	140	35	103	86	7	160	90	115	50	25	30	3.5	134	11	27	79	15
CLIS02004*	230	165	140	35	103	86	7	210	90	115	50	25	30	3.5	134	11	27	79	15
CLIS02503*	180	165	140	35	103	86	7	160	90	115	50	25	30	3.5	134	11	27	79	15
CLIS02504*	230	165	140	35	103	86	7	210	90	115	50	25	30	3.5	134	11	27	79	15
CLIS03153*	230	234	140	50	138	116	7	210	140	145	65	32	38	5	205	11	37	94	20
CLIS03154*	290	234	140	50	138	116	7	270	140	145	65	32	38	5	205	11	37	94	20
CLIS04003*	230	234	185	50	138	116	7	210	140	145	65	32	38	5	205	11	37	94	20
CLIS04004*	290	234	185	50	138	116	7	270	140	145	65	32	38	5	205	11	37	94	20
CLIS05003*	230	250	185	50	138	116	7	210	140	145	65	40	45	6	215	12.5	38	94	20
CLIS05004*	290	250	185	50	138	116	7	270	140	145	65	40	45	6	215	12.5	38	94	20
CLIS06303*	230	250	185	50	138	116	7	210	140	145	65	40	45	6	215	12.5	38	94	20
CLIS06304*	290	250	185	50	138	116	7	270	140	145	65	40	45	6	215	12.5	38	94	20

CL\* - Señalizadores LED / LED signal lights

CL	X Producto Product		XX Voltaje Voltage	X Color Colour	X Corriente Current	X Contacto Contact
A		Indicador LED LED Indicator	01 = 6V	B	1 - AC	0 = Unit Only
			02 = 12V	R		
B		Indicador LED Intermitente LED Indicator Flash Light	03 = 24V	W	2 - DC	1 = NO
			04 = 36V	A		
C		Indicador LED con Timbre LED Indicator Flash Buzzer	05 = 48V	Y	3 - AC / DC	2 = NC
			06 = 110V	V		
D		Timbre Negro Black Buzzer	07 = 127V	X	/	3 = NC / NO
			08 = 130V			
E		Indicador LED Anti-interferencia LED Anti-interference Indicator	09 = 220V			4 = NO / NO
			10 = 380V			
F		Luz Neón Neon Light				
I		Voltímetro Voltmeter				
J		Ampímetro-Voltímetro Ampmeter-Voltmeter				

## CL\* - Señalizadores LED, botones y selectores / LED signal lights, push buttons and switches

### Información técnica / Technical information

- Humedad relativa / *Relative Humidity*: 98%
- Rango de frecuencia de vibraciones en operación normal / *Normal operating vibration frequency range*: 2-80Hz (accel 0.7g)
- Operación en uso continuo / *Continuous operating life*: >= 30,000 horas
- Grado de protección / *Protection grade*: IP40
- Cumple con las siguientes normativas / *Complies with the following standards*: GB/T14048.5 / IEC60947-5-1

### Ventajas / Advantages

- Fácil repuesto de bloques de contacto / *Easy replacement of contact blocks*
- Terminales protegidos para incrementar la seguridad y fiabilidad / *Terminals are protected to increase security and reliability*
- Cuerpo y elemento de fijación en aleación de zinc y aluminio / *Body and fixing element made with alloy of zinc and aluminium*
- Fijación posterior. El botón no puede ser desmontado desde la parte frontal del aparato / *Rear mounted. (Button cannot be dismantled from the front part of the unit)*
- Los bloques de contactos NO y NC son independientes entre si para facilitar la función final de cada elemento de mando / *Both NO and NC contact blocks are independant so as to facilitate the final function of each control element*
- También disponible con grado de protección IP65 e IP67 bajo pedido / *Also available with protection grade of IP65 & IP67 upon request.*

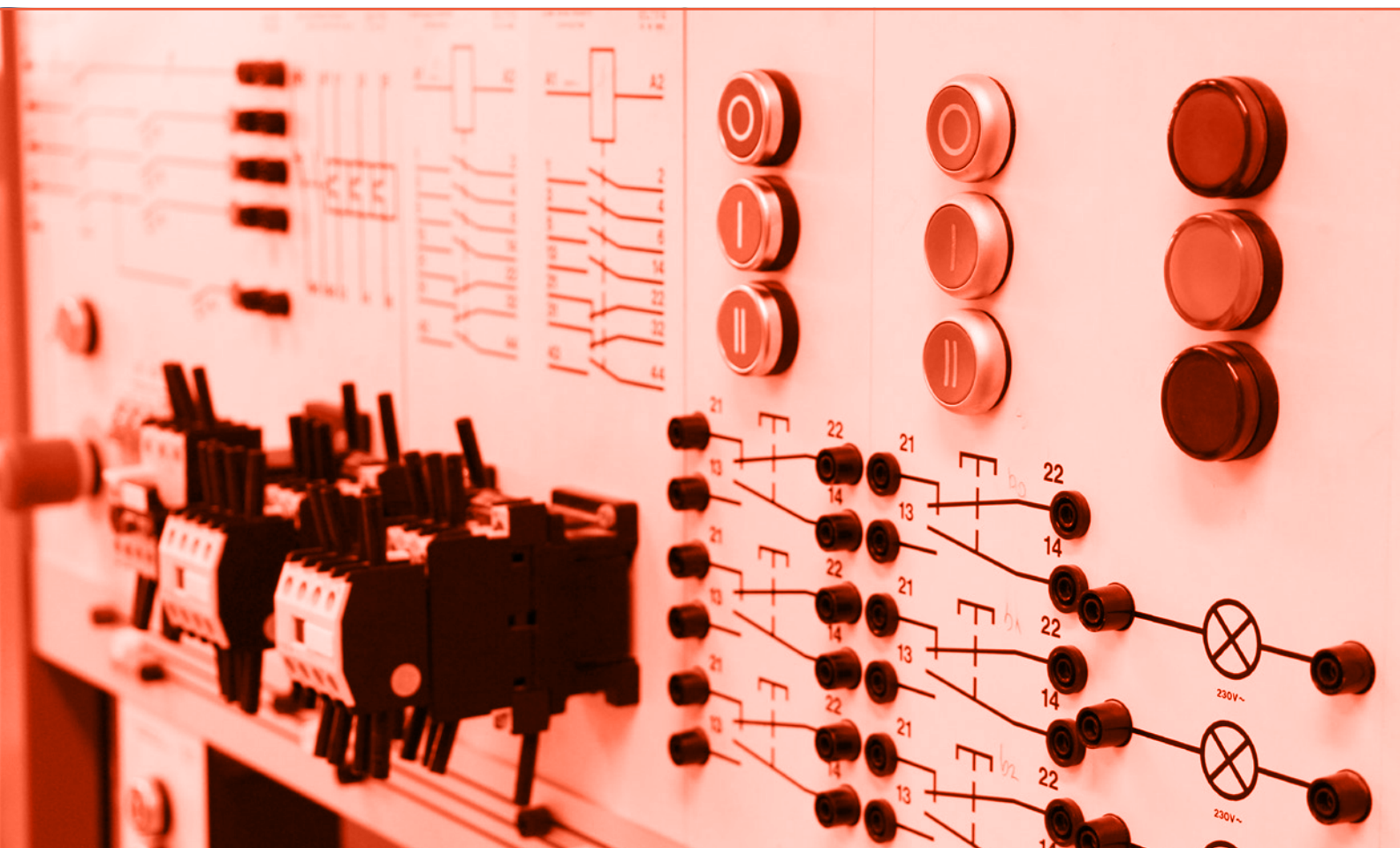

CL\* - Señalizadores LED / LED signal lights



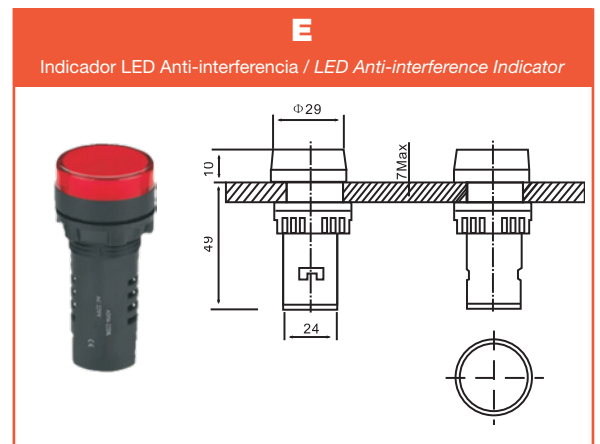
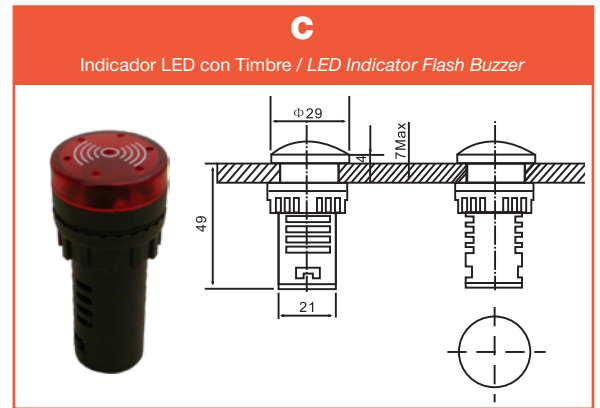
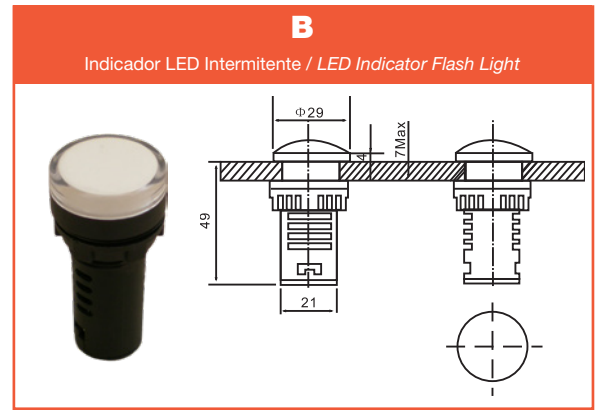
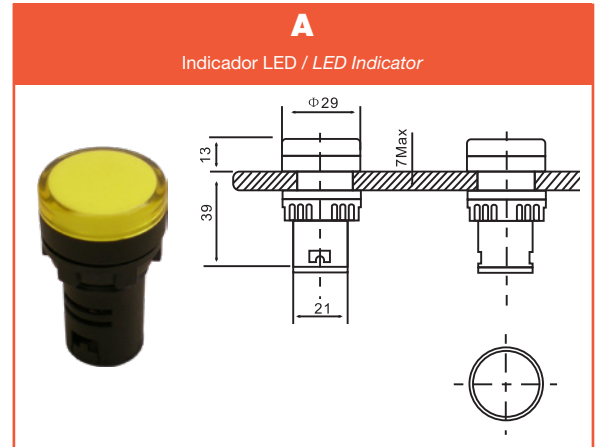

Voltage Voltage	Corriente Current	Color Colour	Referencia / Reference			
			A	B	C	E
6V	AC / DC	Red	CLA01R3	CLB01R3	CLC01R3	CLE01R3
		Green	CLA01V3	CLB01V3	CLC01V3	CLE01V3
		Blue	CLA01A3	CLB01A3	CLC01A3	CLE01A3
		Yellow	CLA01Y3	CLB01Y3	CLC01Y3	CLE01Y3
		White	CLA01W3	CLB01W3	CLC01W3	CLE01W3
12V	AC / DC	Red	CLA02R3	CLB02R3	CLC02R3	CLE02R3
		Green	CLA02V3	CLB02V3	CLC02V3	CLE02V3
		Blue	CLA02A3	CLB02A3	CLC02A3	CLE02A3
		Yellow	CLA02Y3	CLB02Y3	CLC02Y3	CLE02Y3
		White	CLA02W3	CLB02W3	CLC02W3	CLE02W3
24V	AC / DC	Red	CLA03R3	CLB03R3	CLC03R3	CLE03R3
		Green	CLA03V3	CLB03V3	CLC03V3	CLE03V3
		Blue	CLA03A3	CLB03A3	CLC03A3	CLE03A3
		Yellow	CLA03Y3	CLB03Y3	CLC03Y3	CLE03Y3
		White	CLA03W3	CLB03W3	CLC03W3	CLE03W3
36V	AC / DC	Red	CLA04R3	CLB04R3	CLC04R3	CLE04R3
		Green	CLA04V3	CLB04V3	CLC04V3	CLE04V3
		Blue	CLA04A3	CLB04A3	CLC04A3	CLE04A3
		Yellow	CLA04Y3	CLB04Y3	CLC04Y3	CLE04Y3
		White	CLA04W3	CLB04W3	CLC04W3	CLE04W3
48V	AC / DC	Red	CLA05R3	CLB05R3	CLC05R3	CLE05R3
		Green	CLA05V3	CLB05V3	CLC05V3	CLE05V3
		Blue	CLA05A3	CLB05A3	CLC05A3	CLE05A3
		Yellow	CLA05Y3	CLB05Y3	CLC05Y3	CLE05Y3
		White	CLA05W3	CLB05W3	CLC05W3	CLE05W3
110V	AC / DC	Red	CLA06R3	CLB06R3	CLC06R3	CLE06R3
		Green	CLA06V3	CLB06V3	CLC06V3	CLE06V3
		Blue	CLA06A3	CLB06A3	CLC06A3	CLE06A3
		Yellow	CLA06Y3	CLB06Y3	CLC06Y3	CLE06Y3
		White	CLA06W3	CLB06W3	CLC06W3	CLE06W3
127V	AC / DC	Red	CLA07R3	CLB07R3	CLC07R3	CLE07R3
		Green	CLA07V3	CLB07V3	CLC07V3	CLE07V3
		Blue	CLA07A3	CLB07A3	CLC07A3	CLE07A3
		Yellow	CLA07Y3	CLB07Y3	CLC07Y3	CLE07Y3
		White	CLA07W3	CLB07W3	CLC07W3	CLE07W3
220V	AC	Red	CLA09R1	CLB09R1	CLC09R1	CLE09R1
		Green	CLA09V1	CLB09V1	CLC09V1	CLE09V1
		Blue	CLA09A1	CLB09A1	CLC09A1	CLE09A1
		Yellow	CLA09Y1	CLB09Y1	CLC09Y1	CLE09Y1
		White	CLA09W1	CLB09W1	CLC09W1	CLE09W1
220V	DC	Red	CLA09R2	CLB09R2	CLC09R2	CLE09R2
		Green	CLA09V2	CLB09V2	CLC09V2	CLE09V2
		Blue	CLA09A2	CLB09A2	CLC09A2	CLE09A2
		Yellow	CLA09Y2	CLB09Y2	CLC09Y2	CLE09Y2
		White	CLA09W2	CLB09W2	CLC09W2	CLE09W2
380V	AC	Red	CLA10R1	CLB10R1	CLC10R1	CLE10R1
		Green	CLA10V1	CLB10V1	CLC10V1	CLE10V1
		Blue	CLA10A1	CLB10A1	CLC10A1	CLE10A1
		Yellow	CLA10Y1	CLB10Y1	CLC10Y1	CLE10Y1
		White	CLA10W1	CLB10W1	CLC10W1	CLE10W1





CL\* - Señalizadores LED / LED signal lights

Voltaje Voltage	Corriente Current	Referencia / Reference	
		D	
6V	AC / DC	CLD01B3	
12V	AC / DC	CLD02B3	
24V	AC / DC	CLD03B3	
36V	AC / DC	CLD04B3	
48V	AC / DC	CLD05B3	
110V	AC / DC	CLD06B3	
127V	AC / DC	CLD07B3	
220V	AC	CLD09B1	
380V	AC	CLD10B1	
220V	DC	CLD09B2	

Voltaje Voltage	Corriente Current	Color Colour	Referencia / Reference	
			F	
130V Bulb (380V)	50 / 60 Hz		CLF08R	
			CLF08V	
			CLF08A	
			CLF08Y	
			CLF08W	

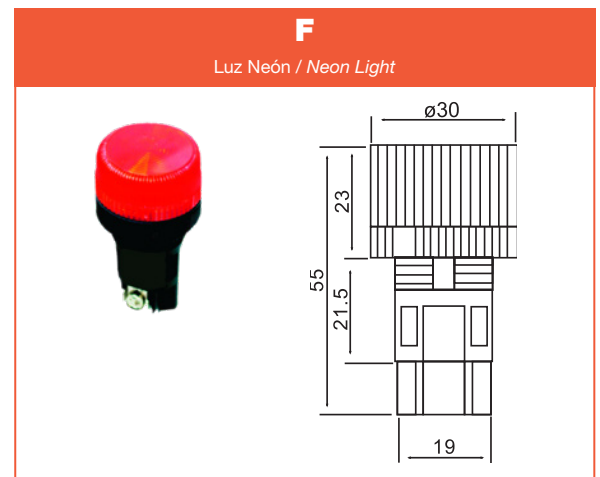
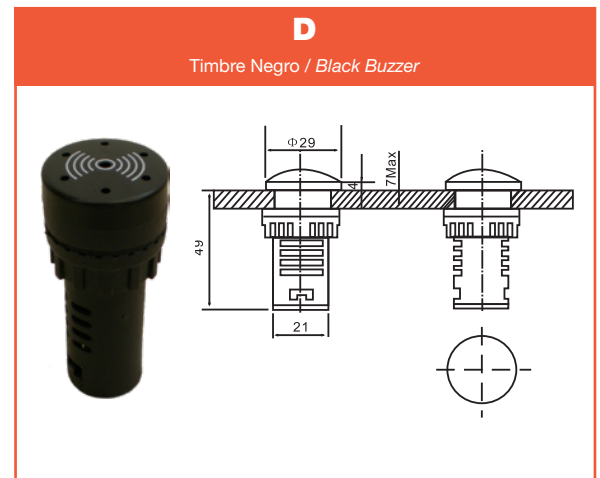

<p><b>CLI09X-10</b> Voltímetro / Voltmeter</p>  <p><b>220V [20 - 500V AC]</b></p>	<p><b>CLJ09X-10</b> Voltímetro-Ampímetro / Voltmeter-Ampmeter</p>  <p><b>220V [20 - 500V AC] [0-50A]</b></p>
--	---

CE UNE EN IEC 60947-4-1

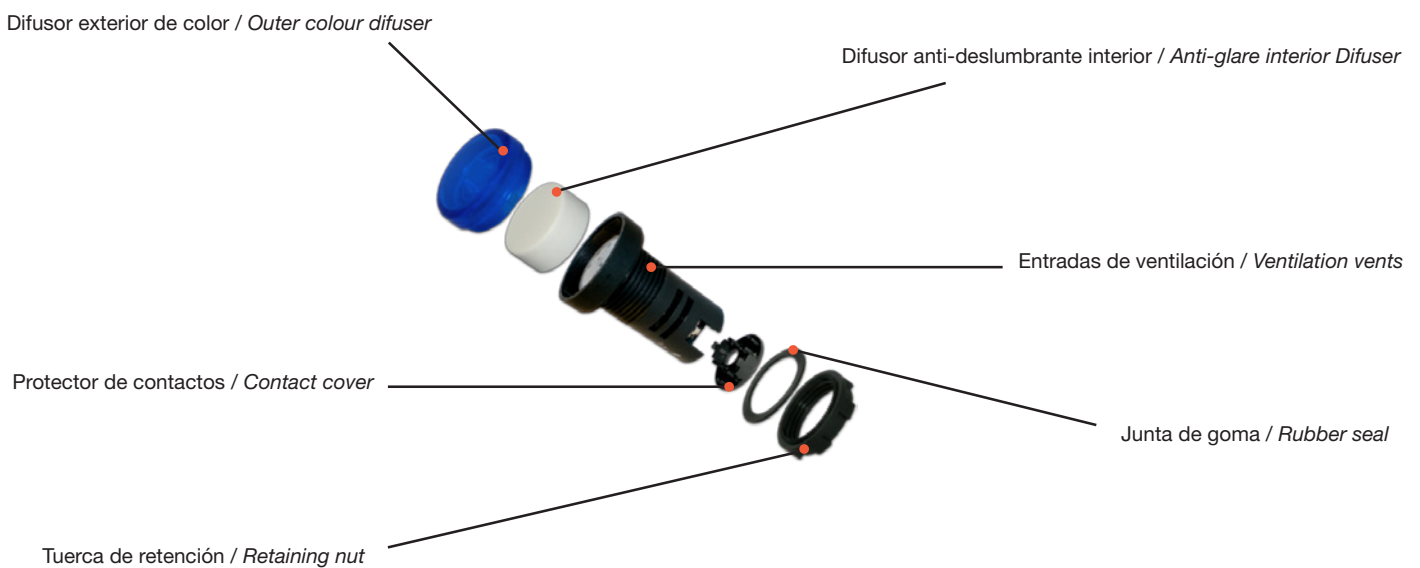

Información general / General information:





Identificación de referencia y producto / Product and reference identification





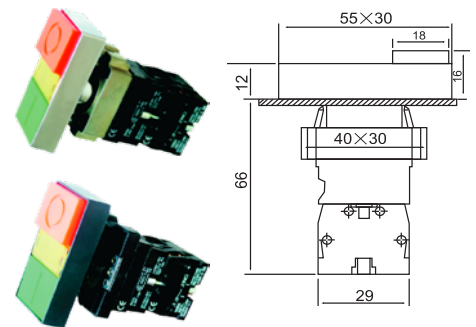
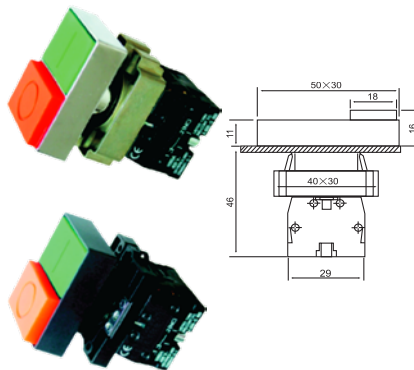
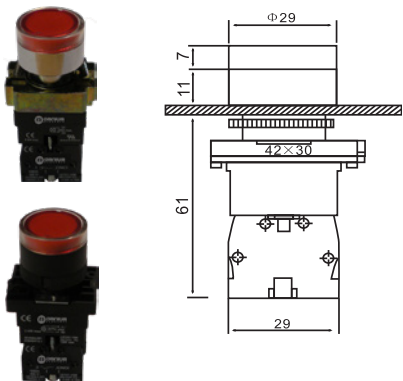
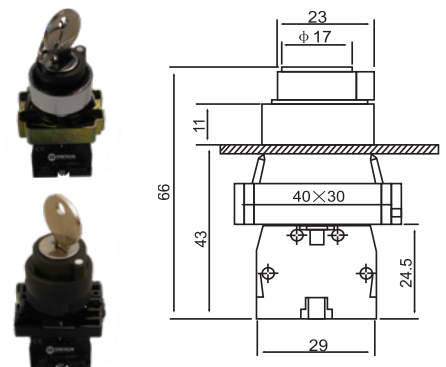
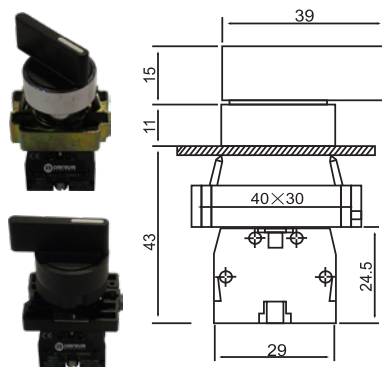
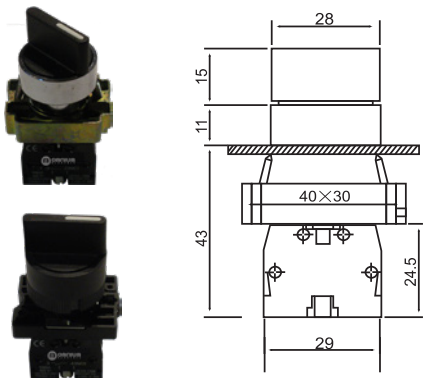
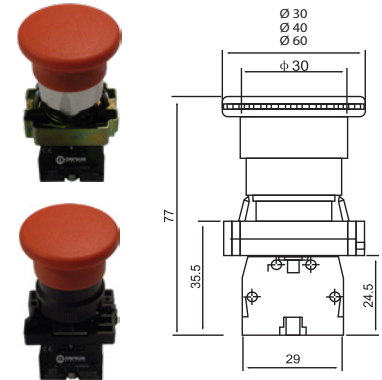
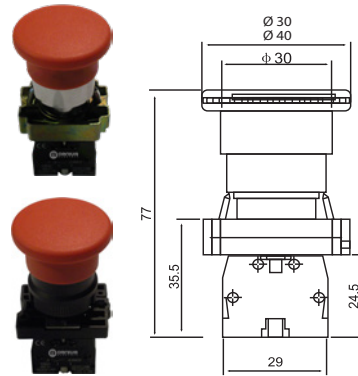
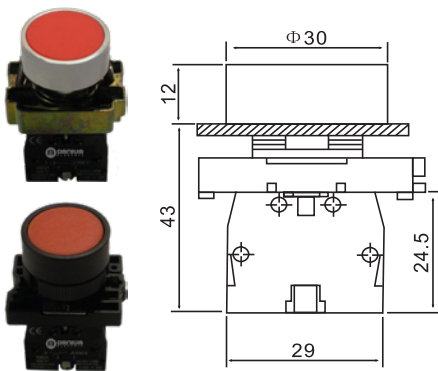

A	Botón rasante - muelle retorno / Flush button - spring return
B	Botón rasante iluminado - muelle retorno / Illuminated Flush button - spring return
C	Botón saliente - muelle retorno / Protruding button - spring return
D	Pulsador doble rasante - muelle retorno / Flush double push button - spring return
E	Pulsador doble (verde rasante/rojo saliente) / Double push button (flush green/protruding red)
F	Pulsador doble - luz piloto (verde rasante/rojo saliente) / Double push button - pilot light (flush green/protruding red)
G	Botón de seta 40Ø / Mushroom Button 40Ø
H	Botón de seta (tirar para retorno) 40Ø / Mushroom Button (push pull) 40Ø
I	Botón de seta (retorno giro) 30Ø / Mushroom Button (turn to release) 30Ø
J	Botón de seta (retorno giro) 40Ø / Mushroom Button (turn to release) 40Ø
K	Botón de seta (retorno giro) 60Ø / Mushroom Button (turn to release) 60Ø
L	Botón de seta (llave para retorno) 30Ø / Mushroom Button (key to release) 30Ø
M	Botón de seta (llave para retorno) 40Ø / Mushroom Button (key to release) 40Ø
N	Botón de seta (llave para retorno) 60Ø / Mushroom Button (key to release) 60Ø
O	Interruptor IP65 (manga corta) / Rotary switch IP65 (short handle)
P	Interruptor IP65 (manga larga) / Rotary switch IP65 (long handle)
Q	Interruptor IP65 (con llave) / Rotary switch IP65 (with key)







	Material Material		X	Tipo Type		X	Posición Position	X	Color Colour		X	Símbolo Symbol		X	Contacto Contact		X	Voltaje Voltage			
	P	M		A	R				B	S		B	I		J	K		L	M	N	O
CL	P	Plástico / Plastic		A	R		0	Pulsador Button		B		I	O	-	Unidad (Sin montar) Unit (Non Mounted)		0		N/A		
	M	Metálico / Metalic		B	S		0			R		J	I	1	NO		1	24V			
				C			1				V		K	II	2	NC		2	110V		
				D			1				A		L	↑	3	NC / NO		3	130V		
				E			1				Y		M	↑	4	NO / NO		4	220V		
				F			1				W		N	START				5	380V		
				G			2				X		O	STOP							
				H			2						P	0 1							
				I									-	N / A							
				J			3														
				K			3														
				L			4														
			M			4															
			N			5															
			O			5															
			P			6															
			Q			6															

Botones y selectores rotativos montados / Mounted push buttons and rotary switches



Botones y selectores rotativos montados / Mounted push buttons and rotary switches



	Producto Product	Contactor Cantactor	Color / Colour					
PLÁSTICO / PLASTIC	 A	NO	CLPAR0B*10	-	CLPAR0V*10	CLPAR0A10	CLPAR0Y10	-
		NC	-	CLPAR0R*20	-	-	-	-
		NO + NC	CLPAR0B*30	CLPAR0R*30	CLPAR0V*30	-	-	-
	 G 40Ø	NC	CLPGR0B20	CLPGR0R20	CLPGR0V20	-	CLPGR0Y20	-
		 H 60Ø	NC	CLPHR0B20	CLPHR0R20	CLPHR0V20	-	CLPHR0Y20
	 I 30Ø		NC	-	CLPIR0R20	-	-	-
 J 40Ø		NC	-	CLPJR0R20	-	-	-	-
	 K 60Ø	NC	-	CLPKR0R20	-	-	-	-

	Producto Product	Contactor Cantactor	Color / Colour					
MEÁLICO / METALIC	 A	NO	CLMAR0B*10	-	CLMAR0V*10	CLMAR0A*10	CLMAR0Y*10	-
		NC	-	CLMAR0R*20	-	-	-	-
		NO + NC	CLMAR0B*30	CLMAR0R*30	CLMAR0V*30	-	-	-
	 G 40Ø	NC	CLMGR0B-20	CLMGR0R-20	CLMGR0V-20	-	CLMGR0Y-20	-
		 H 60Ø	NC	CLMHR0B-20	CLMHR0R-20	CLMHR0V-20	-	CLMHR0Y-20
	 I 30Ø		NC	-	CLMIR0R-20	-	-	-
 J 40Ø		NC	-	CLMJR0R-20	-	-	-	-
	 K 60Ø	NC	-	CLMKR0R-20	-	-	-	-

Botones y selectores rotativos montados / Mounted push buttons and rotary switches

	Producto Product	Posiciones / Positions						Contactos Contacts
								
PLÁSTICO / PLASTIC		CLPOR1B-10	CLPOR2B-10	CLPOR3B-10	CLPOR4B-10	CLPOR5B-10	-	NO
		CLPOR1B-30	CLPOR2B-30	CLPOR3B-30	CLPOR4B-30	CLPOR5B-30	-	NO+NC
		-	-	CLPOR3B-40	-	-	CLPOR6B-40	NO+NO
		CLPPR1B-10	CLPPR2B-10	CLPPR3B-10	CLPPR4B-10	CLPPR5B-10	-	NO
		CLPPR1B-30	CLPPR2B-30	CLPPR3B-30	CLPPR4B-30	CLPPR5B-30	-	NO+NC
		-	-	CLPPR3B-40	-	-	CLPPR6B-40	NO+NO
		CLPQR1B-10	CLPQR2B-10	CLPQR3B-10	CLPQR4B-10	CLPQR5B-10	-	NO
		CLPQR1B-30	CLPQR2B-30	CLPQR3B-30	CLPQR4B-30	CLPQR5B-30	-	NO+NC
		-	-	CLPQR3B-40	-	-	CLPQR6B-40	NO+NO
MEÁLICO / METALLO		CLMOR1B-10	CLMOR2B-10	CLMOR3B-10	CLMOR4B-10	CLMOR5B-10	-	NO
		CLMOR1B-30	CLMOR2B-30	CLMOR3B-30	CLMOR4B-30	CLMOR5B-30	-	NO+NC
		-	-	CLMOR3B-40	-	-	CLMOR6B-40	NO+NO
		CLMPR1B-10	CLMPR2B-10	CLMPR3B-10	CLMPR4B-10	CLMPR5B-10	-	NO
		CLMPR1B-30	CLMPR2B-30	CLMPR3B-30	CLMPR4B-30	CLMPR5B-30	-	NO+NC
		-	-	CLMPR3B-40	-	-	CLMPR6B-40	NO+NO
		CLMQR1B-10	CLMQR2B-10	CLMQR3B-10	CLMQR4B-10	CLMSR5B-10	-	NO
		CLMQR1B-30	CLMQR2B-30	CLMQR3B-30	CLMQR4B-30	CLMQR5B-30	-	NO+NC
		-	-	CLMQR3B-40	-	-	CLMQR6B-40	NO+NO

Botones y selectores rotativos montados / Mounted push buttons and rotary switches

	Producto Product	Voltaje Voltage	Color / Colour					Contacto Contact
PLÁSTICO / PLASTIC		130V	-	CLPBR0R13	CLPBR0V13	CLPBR0A13	CLPBR0Y13	CLPBR0W13
		220V	-	CLPBR0R14	CLPBR0V14	CLPBR0A14	CLPBR0Y14	CLPBR0W14
		380V	-	CLPBR0R15	CLPBR0V15	CLPBR0A15	CLPBR0Y15	CLPBR0W15
MEÁLICO / METALIC		130V	-	CLMBR0R13	CLMBR0V13	CLMBR0A13	CLMBR0Y13	CLMBR0W13
		220V	-	CLMBR0R14	CLMBR0V14	CLMBR0A14	CLMBR0Y14	CLMBR0W14
		380V	-	CLMBR0R15	CLMBR0V15	CLMBR0A15	CLMBR0Y15	CLMBR0W15

	Producto Product	Voltaje Voltage	Color / Colour					Contactos Contacts	
MEÁLICO / METALIC		N/A		CLPDS0X30				NO+NC	
			N/A		CLPES0X30				
				130V		CLPFS0X33			
220V				CLPFS0X34					
380V		CLPFS0X35							
MEÁLICO / METALIC		N/A		CLMDS0X30				NO+NC	
			N/A		CLMES0X30				
				130V		CLMFS0X33			
220V				CLMFS0X34					
380V		CLMFS0X35							



Accesorios para botones y selectores rotativos / Push button and rotary switch accessories

Producto Product	Descripción Description	Referencia Reference	
	Contactador tipo NO / NO Type Contactor	CLNO	
	Contactador tipo NC / NC Type Contactor	CLNC	
	Chasis de plástico / Plastic Chassis	CLPX	
	Chasis metálico / Metal Chassis	CLMX	
	Tapón de silicona / Silica gel cover	CLSGC	
	Modulo de cierre automático / Self-locking module	CLSLM	
	Portalámparas (tipo rosca) / Bulb Unit (screw type)	CLBUS	
	Portalámparas (tipo bayoneta) / Bulb Unit (push/twist type)	CLBUB	
	Tapa ciega 22Ø / Panel Plug 22Ø	CLPP	
	Caja para pulsadores y selectores / Pushbutton and switch box	1 Modulo/Module	CLPXBOX1
		2 Modulos/Modules	CLPXBOX2
		3 Modulos/Modules	CLPXBOX3
		4 Modulos/Modules	CLPXBOX4





## óptima

Una extensa serie de cajas de distribución IP30 - IP40 de empotrar y de superficie, con diseño moderno, para instalación en el interior de viviendas, locales comerciales, oficinas, etc. La serie Optima incluye todos los accesorios necesarios para garantizar una instalación segura, profesional y elegante.

*An extensive range of flush and surface fit IP30 - IP40 distribution box, with a modern design, suitable for indoor installations in houses, shops, offices, etc. The Optima range includes all the necessary accessories to guarantee a secure, professional and elegant installation.*

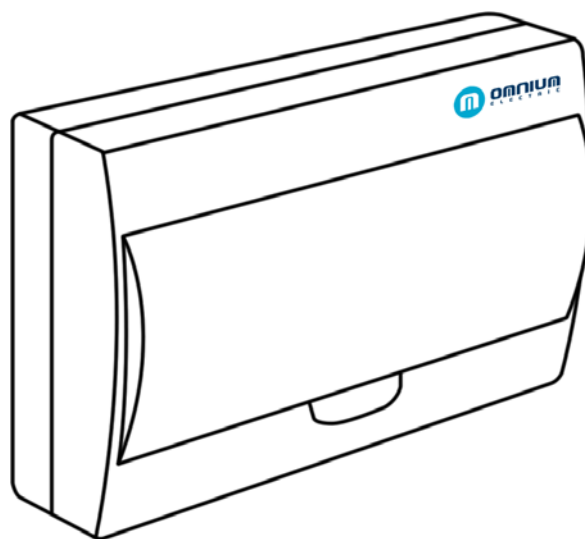

**Cajas de distribución IP30 - IK07**

*Distribution boxes IP30 - IK07*

104

**Cajas de distribución IP40 - IK07**

*Distribution boxes IP40 - IK07*

105

**IP30 - IK07 - Cajas de distribución / Distribution boxes**

- Protección: IP30 & IK07  
*Protection: IP40 & IK07*
- Fabricadas conforme UNE EN 62208  
*Manufactured conforming to UNE EN 62208*
- Material aislante, resistente a impactos  
*Insulating, Impact-proof material*
- Ensayo hilo incandescente a 650°C  
*Glow wire tested at 650°C*
- Ensayo bola a presión a 70°C  
*Ball pressure tested at 70°C*
- Temperatura ambiente en lugar de utilización -5°C hasta 40°C  
*Suitable for installation and use in ambient temperatures of -5°C up to 40°C*
- Temperatura durante transporte y almacenaje -25°C hasta 55°C  
*Suitable for transportation and storage at temperatures of -25°C up to 55°C*
- Enlazables entre si vía accesorio  
*Can be joined together via accessory*



Referencia <i>Reference</i>	Módulos <i>Modules</i>	Dimensiones / <i>Dimensions</i>			Embalaje / <i>Packing</i> Unid./Caja- <i>Unit/Box</i>
		W	L	D	
O30S02	2	45	130	80	1/200
O30S04	4	90	130	80	1/120
O30S06	6	135	130	80	1/80
O30S08	8	180	130	80	1/20
O30S12	12	225	130	80	1/12

IP30

IK07



UNE EN 62208

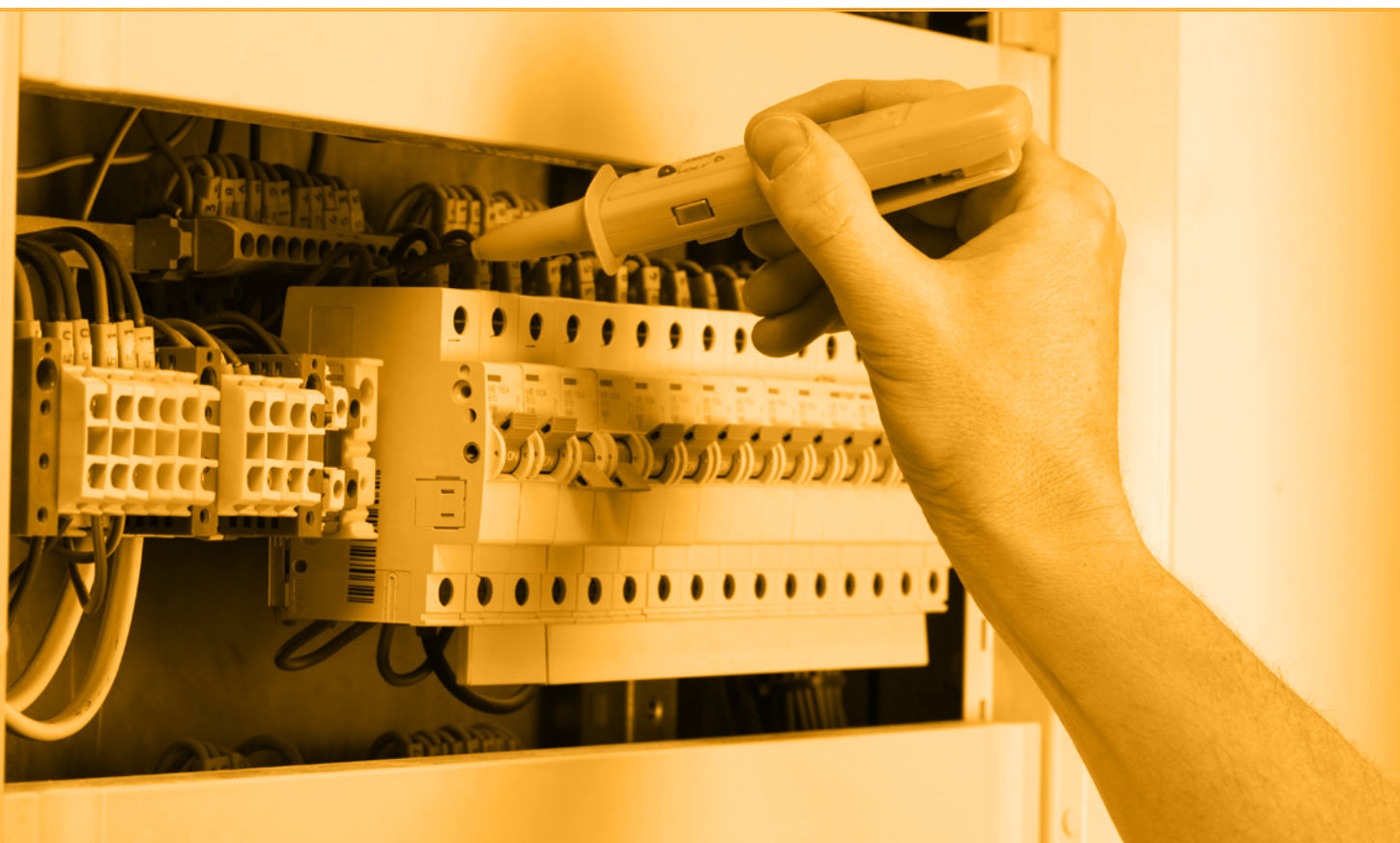

IP40 - IK07 - Cajas de distribución / Distribution boxes

Pretroquelados para ampliar la capacidad de módulos  
Snap-off module covers for additional installation space

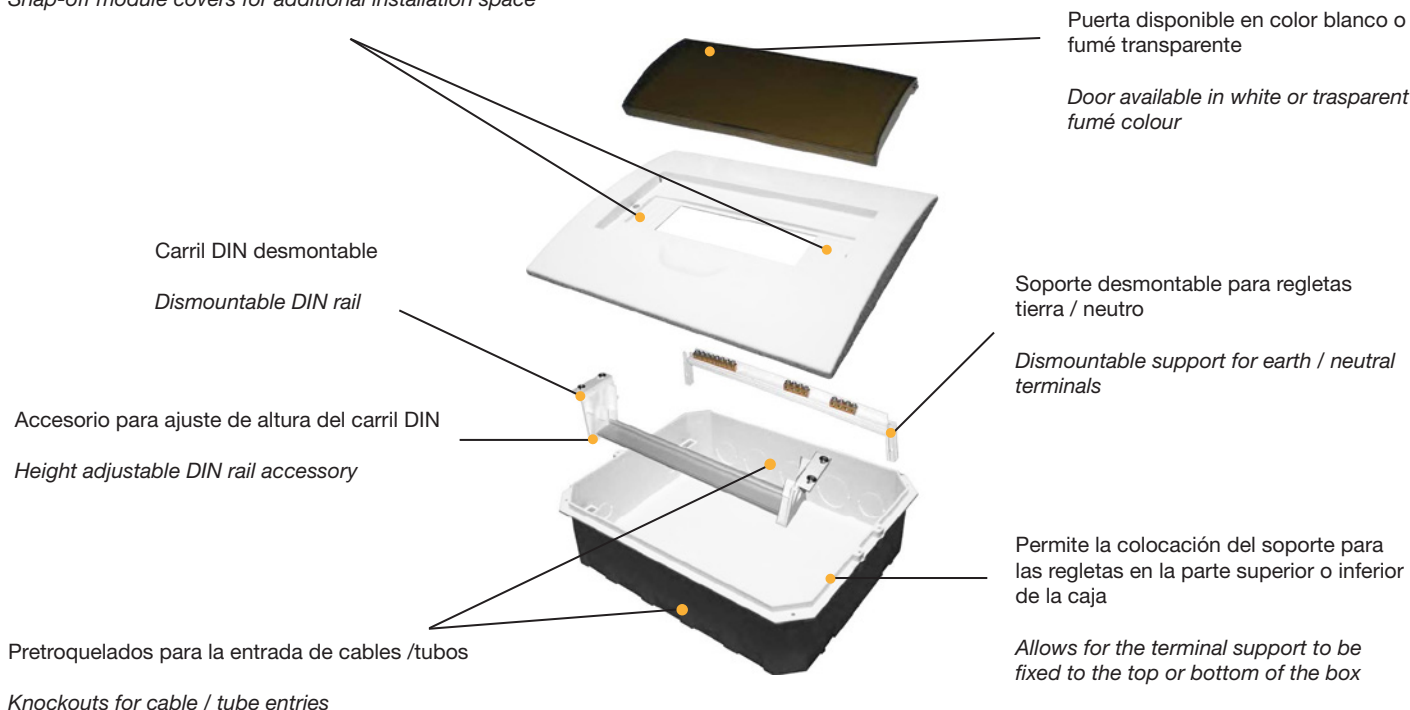

IP40 - IK07 - Cajas de distribución / Distribution boxes

- Protección: IP40 & IK07  
Protection: IP40 & IK07
- Fabricadas conforme UNE EN 60670  
Manufactured conforming to UNE EN 60670
- Material aislante, resistente a impactos  
Insulating, Impact-proof material
- Ensayo hilo incandescente a 650°C  
Glow wire tested at 650°C
- Ensayo bola a presión a 70°C  
Ball pressure tested at 70°C
- Temperatura ambiente en lugar de utilización -5°C hasta 40°C  
Suitable for installation and use in ambient temperatures of -5°C up to 40°C
- Temperatura durante transporte y almacenaje -25°C hasta 55°C  
Suitable for transportation and storage at temperatures of -25°C up to 55°C
- Enlazables entre si vía accesorio  
Can be joined together via accessory

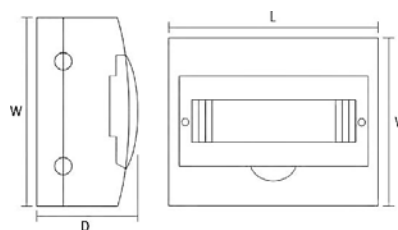

Referencia Reference	Módulos Modules	Dimensiones / Dimensions		
		W	L	D
O40 ★ 04	4	112 (136)	210 (222)	100 (93)
O40 ★ 06	6	148 (172)	210 (222)	100 (93)
O40 ★ 08	8	184 (208)	210 (222)	100 (93)
O40 ★ 12	12	256 (280)	210 (222)	100 (93)
O40 ★ 18	18	364 (398)	222 (252)	100 (127)
O40 ★ 24	24	270 (300)	325 (345)	100 (127)
O40 ★ 36	36	305 (341)	473 (503)	100 (127)

★	Tipo de instalación Type of installation
E	Empotrado / Flush
S	Superficie / Surface

+	Color de puerta Door color
-	Blanco / White
F	Fumé / Tinted







## spa

Una extensa serie de cajas estancas de distribución IP65 de superficie, con diseño moderno, para instalación en zonas exteriores. La serie Spa incluye todos los accesorios necesarios para garantizar una instalación segura, profesional y elegante.

---

*An extensive range of sealed IP65 distribution boxes, with a modern design, for outdoor installations. The range includes all the necessary accessories to guarantee a secure, professional and elegant installation.*

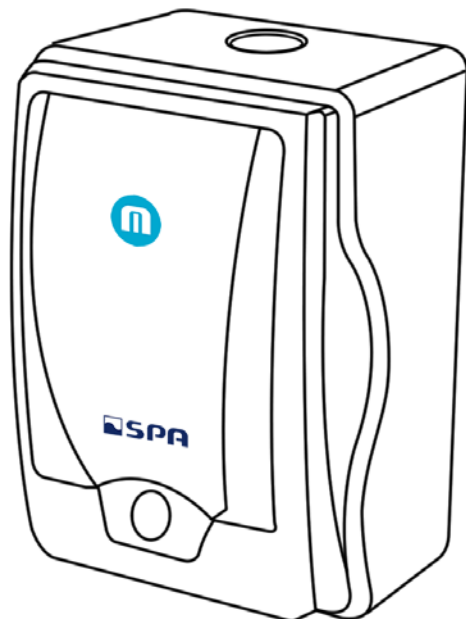



**Información técnica**  
*Technical information*

108

**Cajas de distribución IP65 - IK09**  
*Distribution boxes IP65 - IK09*

109

**IP65 - IK09 - Cajas de distribución / Distribution boxes**
**Información técnica**

- Grados de protección IP65, IK09.
- Fabricadas conforme UNE EN 62208.
- Material termoplástico autoextinguible. Ensayado con hilo incandescente a 850°C.
- Regletas de tierra y neutro con un avanzado sistema de fijación. Disponible con o sin regletas.
- Opción de cerradura metálica como accesorio.
- Amplio espacio para cableado que facilita la instalación.
- Etiquetas para el marcaje de los circuitos.
- Tapones para cubrir los tornillos de fijación y mantener el grado de protección.
- Pretoquelados, en medidas Métricas y PG, para entrada de tubos y para uso de prensaestopos o conos pasa cables.

**Technical information**

- Protection grades: IP65, IK09.
- Manufactured conforming to UNE EN 62208.
- Self-quenching thermoplastic material. Glow wire tested to 850°C.
- Earth and neutral terminal bars with an advanced fixing system. Available with or without terminal bars.
- Metal lock accessory option.
- Ample space for cabling which facilitates installation.
- Labels for markings and circuit identification.
- Stoppers to cover the fixing screws and maintain the protection grade.
- Knockouts, in Metric and PG sizes, for entry of pipes and for use of cable glands and / or cones.

**Opción de cerradura metálica como accesorio**  
*Metal lock accessory option*

**Tapa transparente**  
*Transparent cover*

**Marco con juntas de espuma de poliuretano para mantener el grado de protección**  
*Frame with foamed-in polyurethane gaskets to maintain the protection grade*

**Espacio para el uso de prensaestopos y conos pasa cables**  
*Space for the use of cable glands and cones*

**Regletas de tierra y neutro con un avanzado sistema de fijación. (Disponible como opción)**  
*Earth and neutral terminal bars with an advanced fixing system. (Available as an option)*

**Pretoquelados en medidas Métricas y PG**  
*Knockouts available in Metric and PG sizes*

**Tapones para cubrir los tornillos de fijación y mantener el grado de protección**  
*Stoppers to cover the fixing screws and maintain de protection grade*

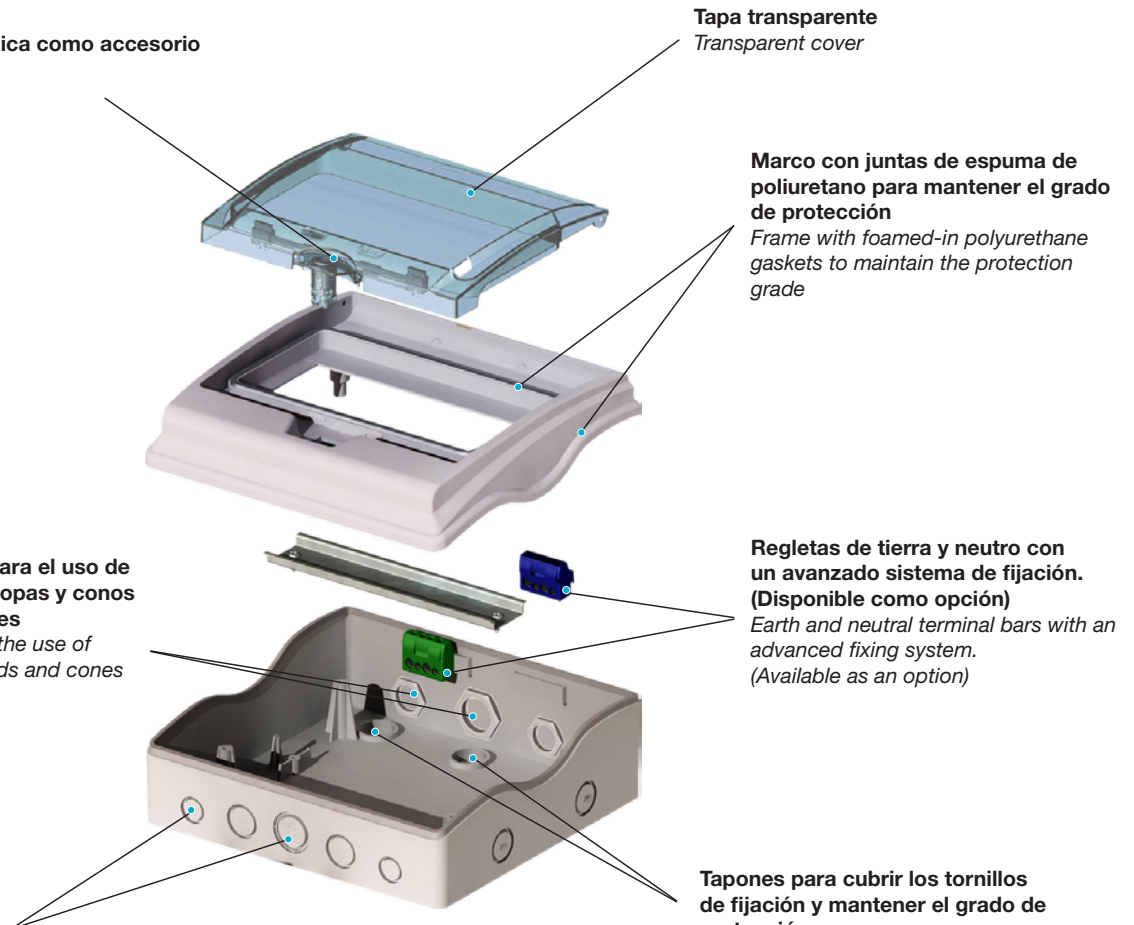

## Características / Features



**Regletas de tierra y neutro con un avanzado sistema de fijación**  
*Earth and neutral terminal bars with an advanced fixing system*



**Opción de cerradura metálica como accesorio**  
*Metal lock accessory option*



**Pretroquelados en medidas Métricas y PG**  
*Metric and PG knockout sizes*



**Tapones para cubrir los tornillos de fijación y mantener el grado de protección**  
*Stoppers to cover the fixing screws and maintain the protection grade*

## SP65\* - IP65 / IK09 - Cajas de distribución / Distribution boxes



Referencia Reference	Módulos Modules	Dimensiones / Dimensions		
		W	L	D
SP6503 ★	3	155	85	90
SP6504 ★	4	155	100	90
SP6506 ★	6	195	150	90
SP6508 ★	8	195	205	90
SP6512 ★	12	195	275	90

★	Tipo de instalación Type of installation
-	Sin terminales / Without terminals
T	Con terminales / With terminals



CE UNE EN 62208

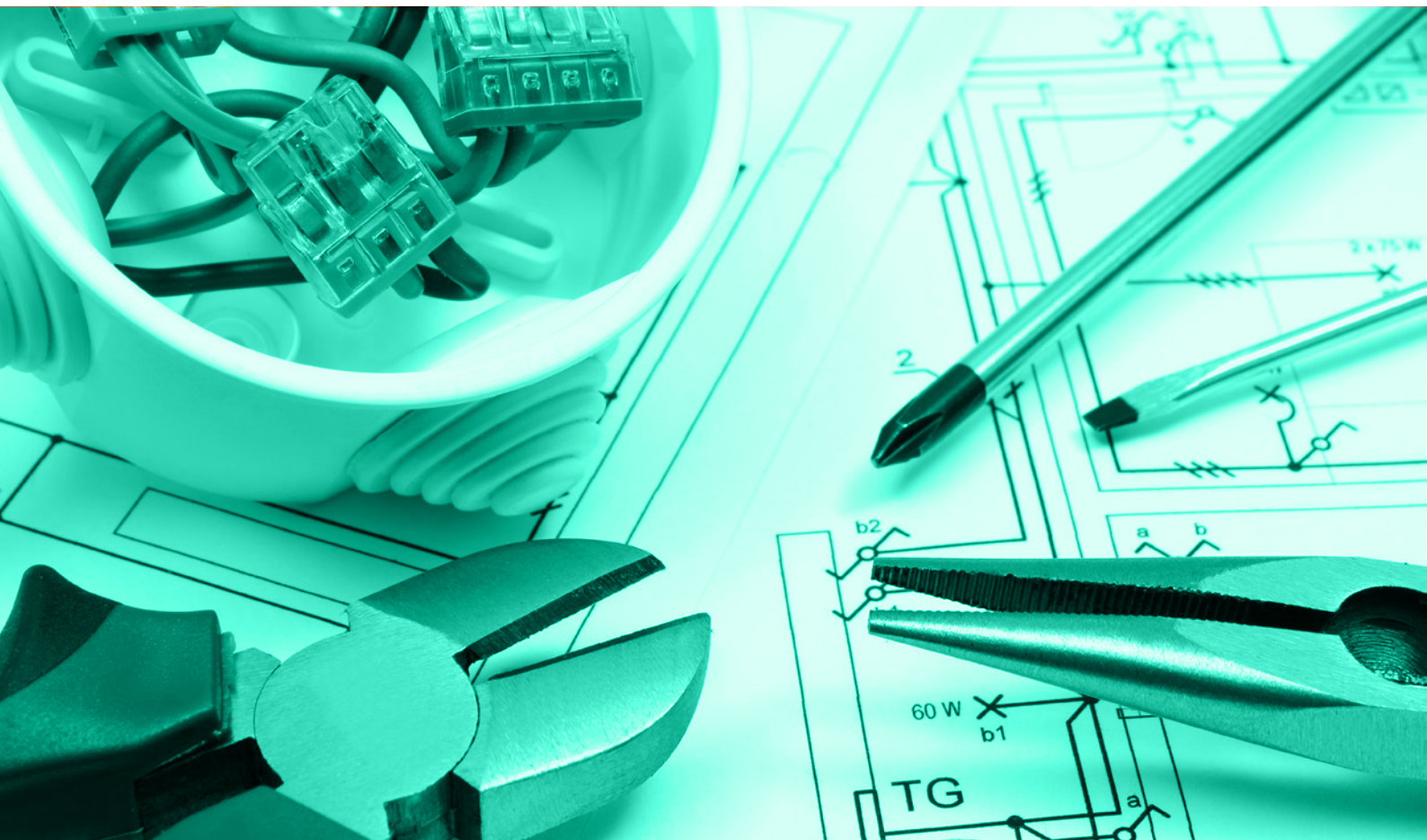

## omnibox

Una extensa serie de cajas estancas IP55 - IP65 & IK09 de superficie, con diseño moderno, para instalación en zonas exteriores. La serie Omnibox incluye todos los accesorios necesarios para garantizar una instalación segura, profesional y elegante.

*An extensive range of sealed IP65 distribution boxes, with a modern design, for outdoor installations. The range includes all the necessary accessories to guarantee a secure, professional and elegant installation.*

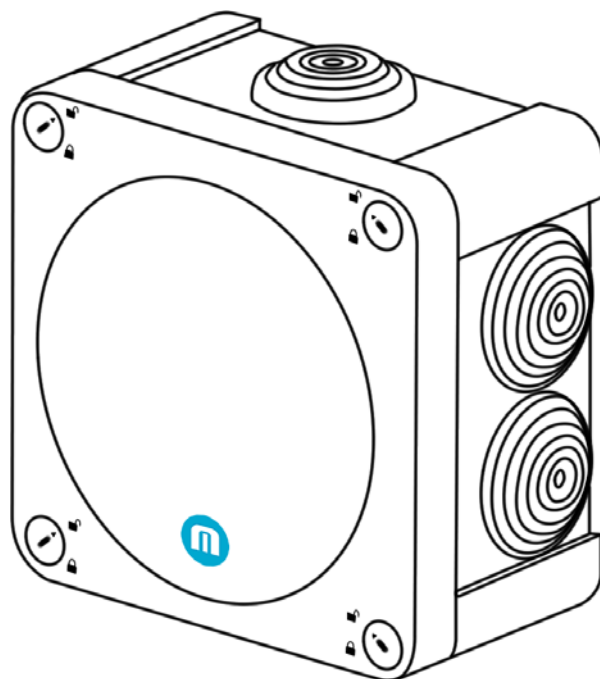

<b>Información técnica</b> <i>Technical information</i>	<b>110</b>
<b>Cajas estancas IP55 - IP65</b> <i>Sealed enclosures IP55 - IP65</i>	<b>112</b>
<b>Cajas estancas universales con tapa transparente IP55</b> <i>Sealed universal enclosures with transparent lid IP55</i>	<b>113</b>

**IP55 - IP65 - Cajas estancas / Sealed enclosures**

**Información técnica**

- Grados de protección IP55 - IP65, IK09
- Fabricadas según la Norma UNE 60670-1
- Material termoplástico. Auto-extinguible
- Ensayo hilo incandescente a 750°C
- 3 versiones: conos, pre-troquelados, paredes lisas
- Tornillos ¼ vuelta para su fácil instalación y uso
- Accesorio para la fijación de regletas de conexión u aparatos eléctricos
- Ranuras para la fijación de placas o aparatos eléctricos
- Tapas imperdibles
- Entradas numeradas para facilitar la identificación de circuitos

**Technical information**

- Protection grades: IP55 - IP65, IK09
- Manufactured in compliance to UNE 60670-1
- Self-quenching thermoplastic material
- Glow wire tested to 750°C
- 3 versions: cones, knockouts, flat walls
- Easy to use ¼ turn screws
- Accessory for fixing terminal bars or other electrical equipment
- Grooves designed to fix plates or electrical equipment
- Captive lids
- Numbered cable entries to facilitate circuit identification

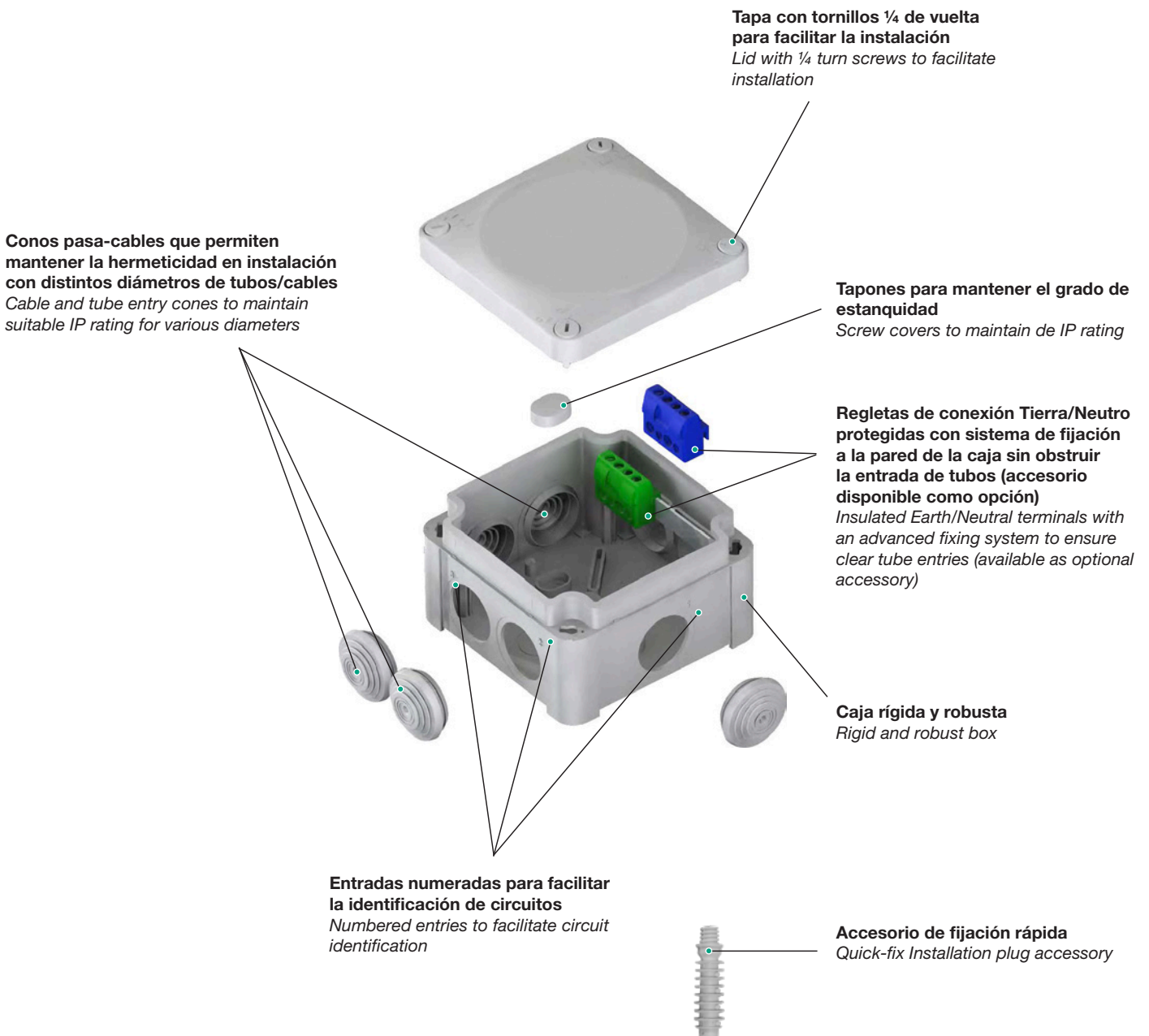



IP55 - IP65 - Cajas estancas / Sealed enclosures



CE

★	Tipo de instalación Type of installation
C	Conos / Cones
P	Pretoquelado / Knockouts
L	Lisa / Flat

Referencia Reference	Grado IP IP Grade	Medidas interiores Internal Dimensions	Tipo de tapa Lid type	Para ref. con conos / For ref. with cones			
				N° entradas & ø (mm) / N° of entries and ø			
				ø 20 (mm) (M20)	ø 25 (M25)	ø 32 (M32)	ø 40 (M40)
OBC0704P	55	ø 70x40mm	Presión / Pressure	4	-	-	-
OB ★ 0808P	55	80x80x45mm	Presión / Pressure	7	-	-	-
OB ★ 1010P	55 & 65	100x100x45mm	Presión / Pressure	7	-	-	-
OB ★ 1010S	55 & 65	100x100x55mm	Tornillo / Screw	-	7	-	-
OB ★ 1510S	55 & 65	150x105x80mm	Tornillo / Screw	-	10	-	-
OB ★ 1715S	55 & 65	175x150x80mm	Tornillo / Screw	-	10	2	-
OB ★ 2217S	55 & 65	225x175x100mm	Tornillo / Screw	-	4	8	-
OB ★ 3227S	55 & 65	325x275x120mm	Tornillo / Screw	-	-	10	10

CE UNE EN 60670-1

Accesorios / Accessories

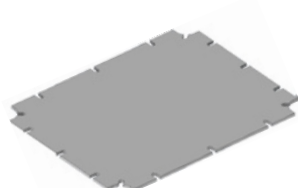

Placa / Plate	
Referencia guía DIN DIN rail reference	Para referencias For references
OBB1510	OBC1510S, OBP1510S, OBL1510S
OBB1715	OBC1715S, OBP1715S, OBL1715S
OBB2217	OBC2217S, OBP2217S, OBL2217S



Accesorio taco pared / Wall Plug Accessory	
Referencia References	Para referencias For references
OBM8	OB*0704P, OB*0808P, OB*1010P, OB*1010S



Accesorio terminales / Terminal Accessory	
Referencia References	Para referencias For references
OBBA	OB*1010S, OB*1510S

IP55 - Cajas estancas universales con tapa transparente / Universal sealed enclosures with transparent lid



Referencia Reference	Grado IP IP Grade	Dimensiones Dimensions	Tipo de tapa Lid type	Materiales Materials
OBL283813STP	55	280 x 380 x 130mm	Tornillo / Screw	Base ABS / ABS Base Tapa PC / PC Lid
OBL303812STP	55	300 x 380 x 120mm	Tornillo / Screw	
OBL303816STP	55	300 x 380 x 160mm	Tornillo / Screw	Placa Montaje ABS Perforada / Perforated ABS Mounting Plate
OBL304018STP	55	300 x 400 x 180mm	Tornillo / Screw	

CE UNE EN 60670-1



## acerbox

La serie AcerBox se compone de cajas estancas de acero, con panel trasero incluido, que ofrecen un grado de protección IP66. Cada caja es tratada con productos especiales de tecnología avanzada, incluyendo una capa de poliéster híbrido, que le proporciona una alta protección contra la corrosión.

*The AcerBox series is comprised of steel enclosures, including mounting plate, offering a protection rating of IP66. Each box is treated with special advanced technological products including a hybrid polyester powder coating that provides a high level of protection against corrosion.*

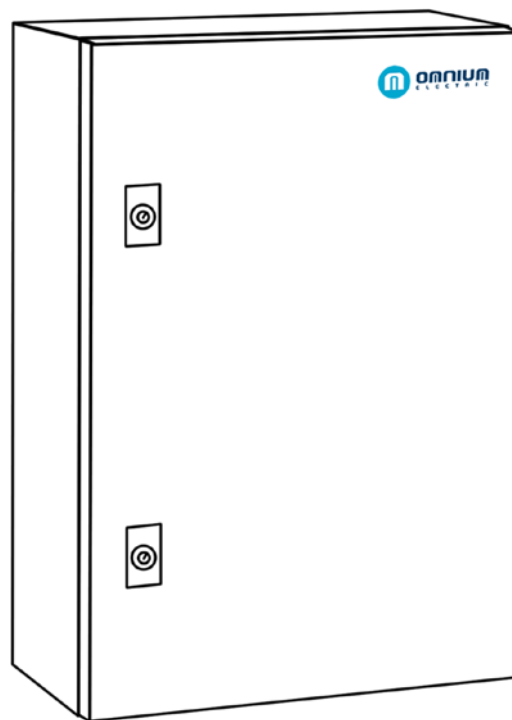

Armarios metálicos IP66  
*Metalic enclosures IP66*

116

**IP66 - Armarios metálicos / *Metalic enclosures***

**Información general**

- Grado de protección IP66 & IK10
- Fabricadas según la Norma UNE-EN 62208
- Fabricado de una longitud continua de acero
- Protegido con resina epoxy de poliéster
- Pintado en gris granulado a RAL-7032
- Pernos soldados en la parte posterior para fijación directa de la placa de montaje u otros accesorios
- Bisagras encubiertas y fácil de desprender
- Junta de espuma de poliuretano y canal de lluvia delantero; asegura un alto grado de protección

**General information**

- Protection grade IP66 & IK10
- Manufactured in compliance to UNE-EN 62208
- Made from a continuous length of steel
- Protected with polyester epoxy resin
- Painted in grained grey to RAL-7032
- Welded studs at the back for direct fixing of mounting plate and other accessories
- Concealed and easily removable hinges
- Foamed-in polyurethane gasket and front rain gutter ensures high degree of protection

**Detalles técnicos y ventajas / *Technical features and advantages***



Sistema de cierre resistente  
*Durable locking system*



Sistema de fijación a la pared  
*Wall fixing system*



Puertas con perfil reforzado  
*Reinforced door profile*



Bisagras encubiertas y desprendibles  
*Concealed and removable hinges*



Junta de espuma de poliuretano  
*Foamed-in polyurethane gasket*



Puerta reversible  
*Reversible door*

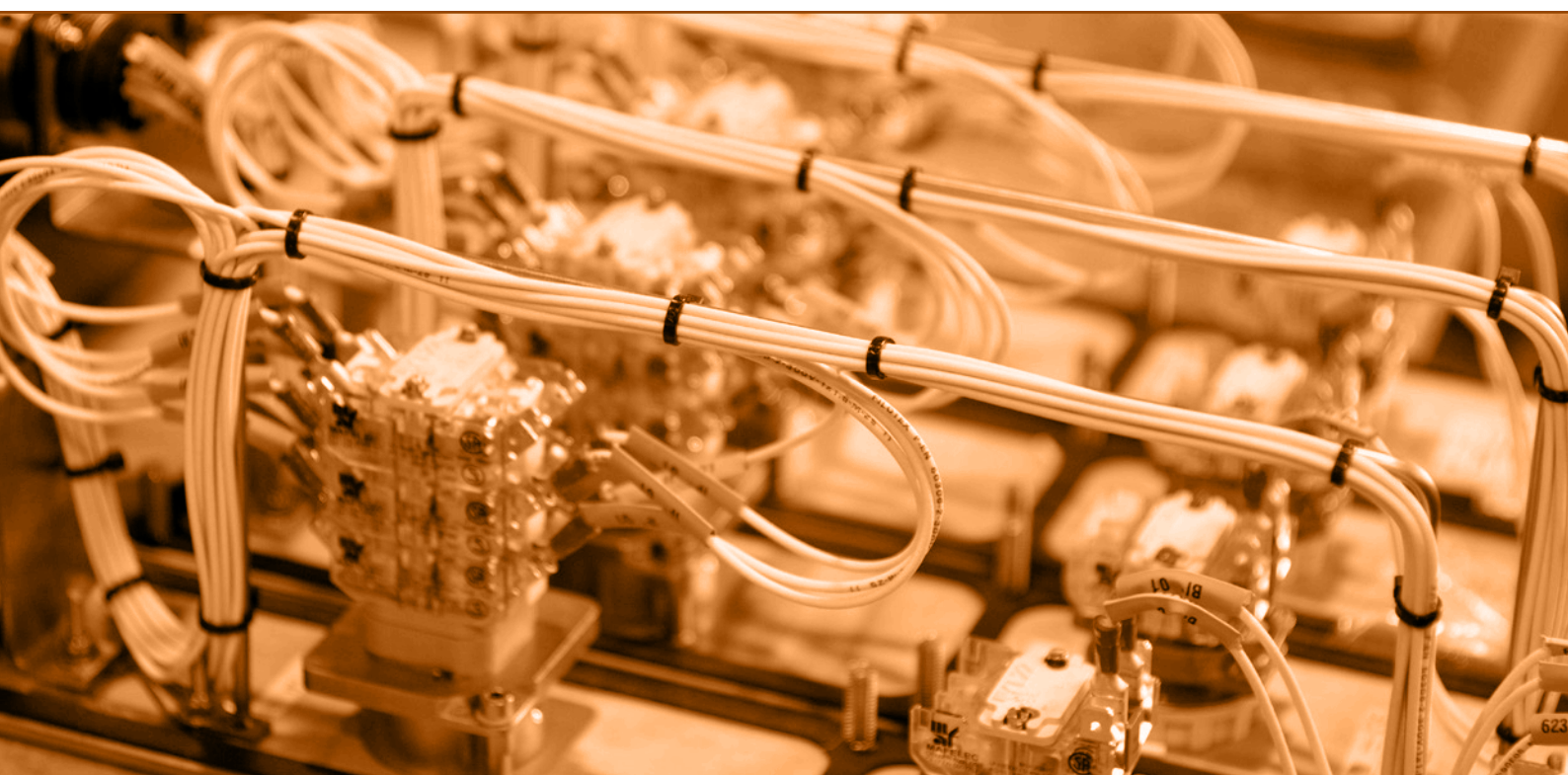

IP66 - Armarios metálicos / *Metalic enclosures*



Referencia <i>Reference</i>	Dimensiones (mm) <i>Dimensions (mm)</i>			Grosura Metal (mm) <i>Metal Thickness (mm)</i>			Tamaño Tornillo Panel Trasero <i>Back Panel Fixing screw</i>
	H	W	D	Cuerpo <i>Body</i>	Puerta <i>Door</i>	Panel Trasero <i>Back Panel</i>	
AB252015	250	200	150	1,00	1,00	2,00	M6
AB302515	300	250	150	1,00	1,00	2,00	M6
AB303015	300	300	150	1,20	1,20	2,00	M6
AB403015	400	300	150	1,20	1,20	2,00	M6
AB403020	400	300	200	1,20	1,20	2,00	M6
AB504015	500	400	150	1,20	1,20	2,00	M6
AB504020	500	400	200	1,20	1,20	2,00	M6
AB504025	500	400	250	1,20	1,20	2,00	M6
AB605015	600	500	150	1,20	1,20	2,00	M8
AB604020	600	400	200	1,20	1,20	2,00	M8
AB605020	600	500	200	1,20	1,20	2,00	M8
AB605025	600	500	250	1,20	1,20	2,00	M8
AB705020	700	500	200	1,20	1,20	2,00	M8
AB705025	700	500	250	1,20	1,20	2,00	M8
AB806020	800	600	200	1,50	1,50	2,50	M8
AB806025	800	600	250	1,50	1,50	2,50	M8
AB806030	800	600	300	1,50	1,50	2,50	M8
AB1006025	1000	600	250	1,50	1,50	2,50	M8
AB1008025	1000	800	250	1,50	1,50	2,50	M8
AB1008040	1000	800	400	1,50	1,50	2,50	M8
AB1008030	1000	800	300	1,50	1,50	2,50	M8
AB1208030	1200	800	300	1,50	1,50	2,50	M8

CE UNE EN 62208

IP66 - Accesorios / *Accessories*



Opciones adicionales disponibles (bajo pedido) / *Additional available options (upon request)*

- Doble puerta / *Double door*
- Panel trasero en acero galvanizado sin pintar / *Zinc galvanised unpainted back panel*
- Pintura en diferentes colores / *Different exterior colour finish*



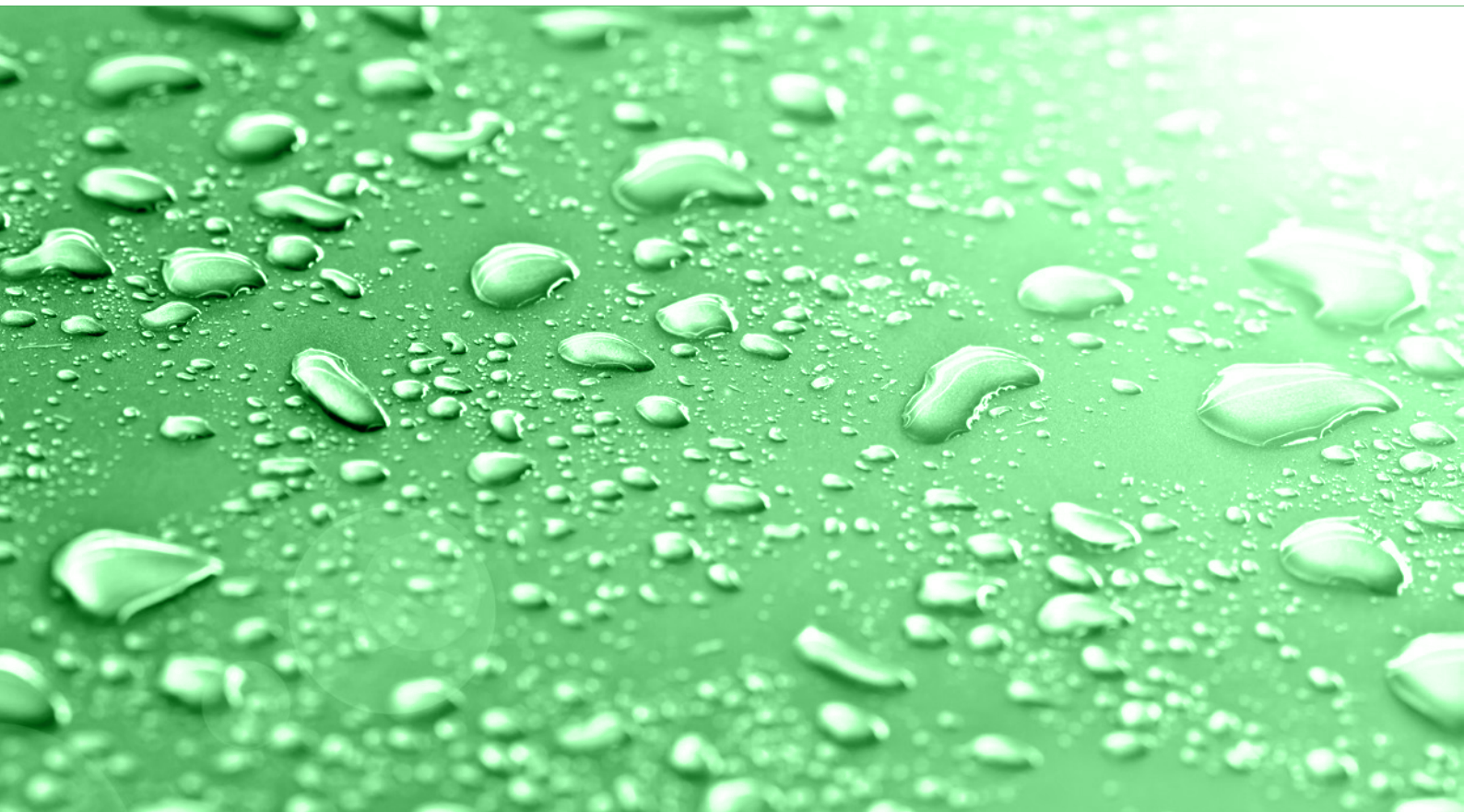

## **aquatite**

Una extensa gama de prensaestopas y membranas IP65 - IP68 que sirven como accesorios perfectos para una instalación estanca y segura. Estos productos son el complemento ideal para las series Omnibox y Spa.

*An extensive range of cable glands and membranes IP65-IP68 that are ideally suited for a perfectly sealed and secure installation. These products are an ideal compliment to the Omnibox and Spa series.*

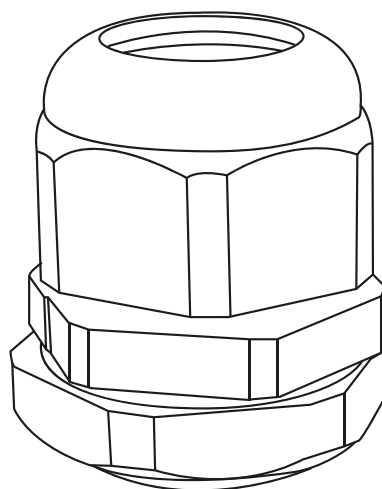



<p><b>Información técnica</b> <i>Technical information</i></p>	120
<p><b>Prensaestopa de nylon IP68</b> <i>Nylon cable glands IP68</i></p>	121
<p><b>Conectores de nylon IP55</b> <i>Nylon connectors IP55</i></p>	122
<p><b>Prensaestopa metálica IP68</b> <i>Metal cable glands Ip68</i></p>	123

**Accesorios estancos / Sealing accessories**

**Información técnica**

- Protección: IP54 hasta IP68
- Resistencia de temperatura: -40°C ~ +100°C
- Resistencia de temperatura a corto plazo: 120°C
- Alivio de tracción
- Disponible en varios colores

**Technical information**

- Protection: IP54 to IP68
- Temperature resistance: -40°C ~ +100°C
- Short time temperature resistance: 120°C
- Strain relief
- Available in a variety of different colours

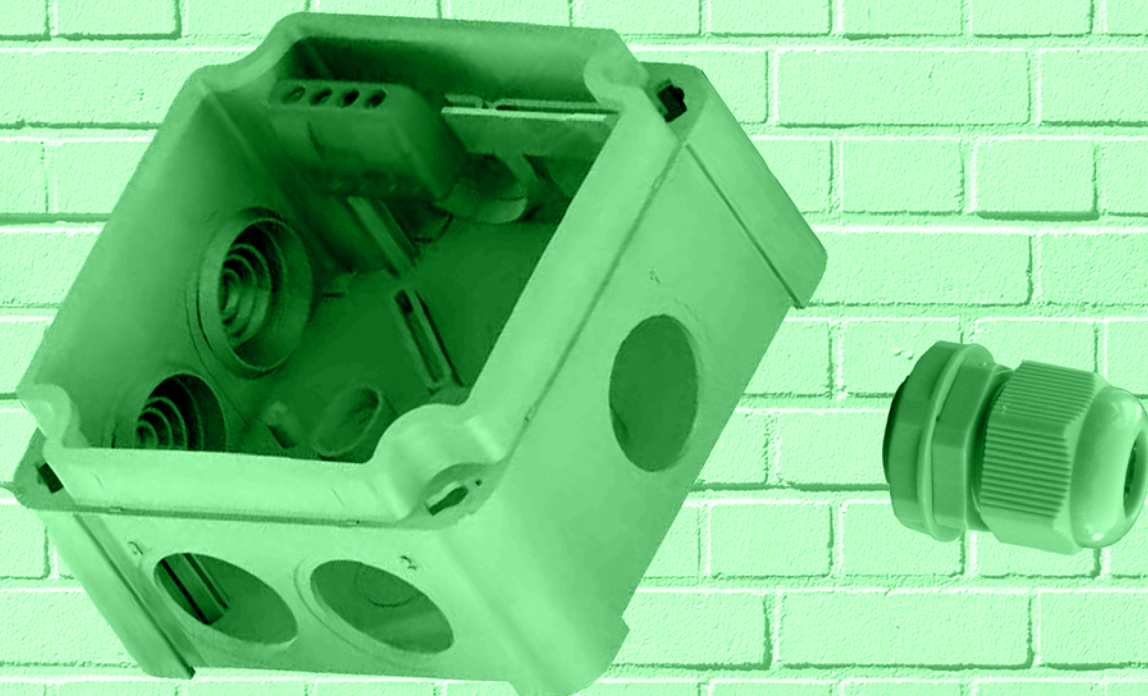

**IP68 - Prensaestopa de nylon / Nylon cable glands**

**Tuerca final fuerte y duradera**  
*Strong and durable end nut*

**Cuerpo con pared interna lisa para evitar el atasco de los cables**  
*Body with smooth internal wall avoids cables being jammed*

**Junta de sellado resistente a productos químicos**  
*Seal gasket resistant to chemicals*

**Junta tórica de sellado**  
*O-ring offers ideal sealing*

**Tuerca autoblocante, fuerte, duradera y resistente a vibraciones**  
*Self locking, strong, durable cap nut resists vibrations*

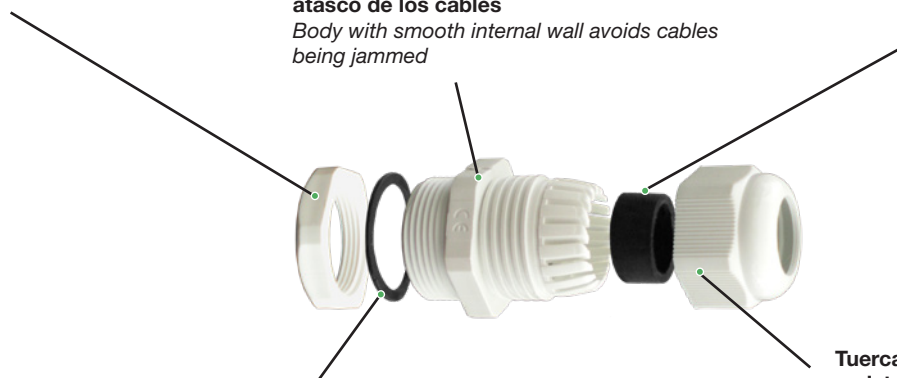

**PRENSAESTOPA DE NYLON (métrica) IP68**  
**NYLON CABLE GLANDS (metric) IP68**

Referencia Reference	AG (M)	GL (mm)	H (mm)	Llave Spanner	Rango de cable Cable range (mm)
ATM12*	M12x1,5	8,0	21,0	15	3,0 ~ 6,5
ATM16*	M16x1,5	8,0	22,0	19	4,0 ~ 8,0
ATM20*	M20x1,5	9,0	27,0	24	6,0 ~ 12,0
ATM25*	M25x1,5	11,0	29,0	27	12,0 ~ 16,0
ATM32*	M32x1,5	12,0	33,0	38	15,0 ~ 23,0
ATM40*	M40x1,5	18,0	45,0	46	22,0 ~ 32,0
ATM50*	M50x1,5	18,0	47,0	56	32,0 ~ 38,0
ATM63*	M63x1,5	20,0	47,0	68	37,0 ~ 44,0

**PRENSAESTOPA DE NYLON (PG) IP68**  
**NYLON CABLE GLANDS (PG) IP68**

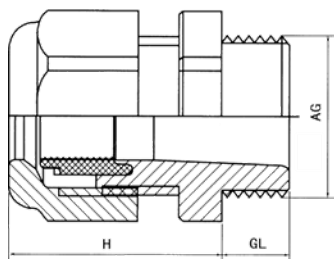

Referencia Reference	AG (PG)	GL (mm)	H (mm)	Llave Spanner	Rango de cable Cable range (mm)
ATPG07*	PG7	8,0	21,0	15	3,0 ~ 6,5
ATPG09*	PG9	8,0	22,0	19	4,0 ~ 8,0
ATPG11*	PG11	8,0	25,0	22	5,0 ~ 10,0
ATPG13*	PG13,5	9,0	27,0	24	6,0 ~ 12,0
ATPG16*	PG16	10,0	28,0	27	10,0 ~ 14,0
ATPG21*	PG21	11,0	31,0	33	13,0 ~ 18,0
ATPG29*	PG29	11,0	39,0	42	18,0 ~ 25,0
ATPG36*	PG36	13,0	48,0	53	22,0 ~ 32,0
ATPG42*	PG42	13,0	48,0	60	32,0 ~ 38,0
ATPG48*	PG48	14,0	49,0	65	37,0 ~ 44,0

**\* = Reemplazar con / Replace with:**

**B** = Negro / Black

**C** = Crema / Cream

**G** = Gris / Grey

**W** = Blanco / White

(Consulte para otros colores / enquire for other colours)

**IP55 - Conectores de nylon / Nylon connectors**

**Junta de sellado resistente a productos quimicos**  
*Seal gasket resistant to chemicals*

**Junta de sellado resistente a productos quimicos**  
*Seal gasket resistant to chemicals*



**CONECTOR DE NYLON (métrico) IP55  
NYLON CONNECTOR (metric) IP55**



Referencia Reference	AG (M)	GL (mm)	Rango de cable Cable range (mm)
ATCM16*	M16x1,5	12,0	5,0 ~ 10,0
ATCM20*	M20x1,5	13,0	6,0 ~ 13,0
ATCM25*	M25x1,5	13,0	10,0 ~ 18,0
ATCM32*	M32x1,5	15,0	16,0 ~ 22,0
ATCM40*	M40x1,5	21,0	20,0 ~ 27,0
ATCM50*	M50x1,5	23,0	30,0 ~ 41,0
ATCM63*	M63x1,5	25,0	40,0 ~ 53,0

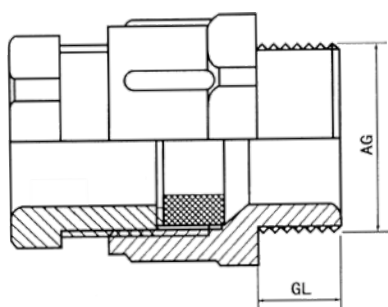

**CONECTOR DE NYLON (PG) IP55  
NYLON CONNECTOR (PG) IP55**

Referencia Reference	AG (M)	GL (mm)	Rango de cable Cable range (mm)
ATCPG07*	PG7	8,0	3,0 ~ 6,5
ATCPG09*	PG9	8,0	4,0 ~ 8,0
ATCPG11*	PG11	8,0	5,0 ~ 10,0
ATCPG13*	PG13,5	9,0	6,0 ~ 12,0
ATCPG16*	PG16	10,0	10,0 ~ 14,0
ATCPG21*	PG21	11,0	13,0 ~ 18,0
ATCPG29*	PG29	11,0	18,0 ~ 25,0
ATCPG36*	PG36	13,0	22,0 ~ 32,0
ATCPG42*	PG42	13,0	32,0 ~ 38,0
ATCPG48*	PG48	14,0	37,0 ~ 44,0

**\* = Reemplazar con / Replace with:**

**B** = Negro / Black

**C** = Crema / Cream

**G** = Gris / Grey

**W** = Blanco / White



**IP68 - Prensaestopa metálica / Metal cable glands**

**Garras que proporcionan un excelente sellado y adaptación a cables de sección no circular**  
*Claw shape provides large sealing area and excellent adaptation to cables with non-circular section*

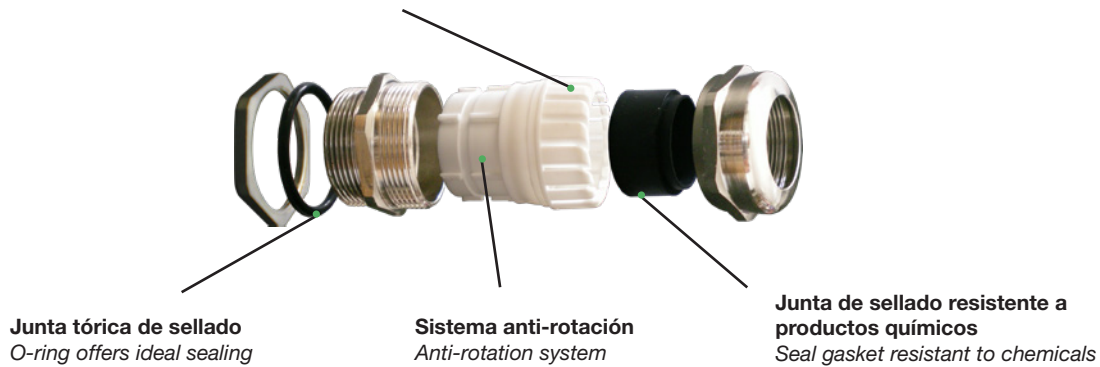

**PRENSAESTOPA METALICA (métrica) IP68**  
**METAL CABLE GLANDS (metric) IP68**



Referencia Reference	AG (M)	GL (mm)	H (mm)	Llave Spanner	Rango de cable Cable range (mm)
ATMM12	M12x1,5	5,0	19,0	14	3,0 ~ 6,5
ATMM16	M16x1,5	6,0	20,0	17	4,0 ~ 8,0
ATMM20	M20x1,5	6,0	22,0	22	6,0 ~ 12,0
ATMM25	M25x1,5	7,0	25,0	30	13,0 ~ 18,0
ATMM32	M32x1,5	8,0	29,0	40	18,0 ~ 25,0
ATMM40	M40x1,5	8,0	35,0	50	22,0 ~ 32,0
ATMM50	M50x1,5	9,0	37,0	57	32,0 ~ 38,0
ATMM63	M63x1,5	10,0	38,0	68	37,0 ~ 44,0

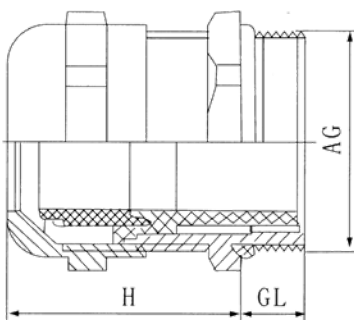

**PRENSAESTOPA METALICA (PG) IP68**  
**METAL CABLE GLANDS (PG) IP68**

Referencia Reference	AG (PG)	GL (mm)	H (mm)	Llave Spanner	Rango de cable Cable range (mm)
ATMPG07	PG7	5,0	19,0	14	3,0 ~ 6,5
ATMPG09	PG9	6,0	20,0	17	4,0 ~ 8,0
ATMPG11	PG11	6,0	21,0	20	5,0 ~ 10,0
ATMPG13	PG13,5	6,5	22,0	22	6,0 ~ 12,0
ATMPG16	PG16	6,5	23,0	24	10,0 ~ 14,0
ATMPG21	PG21	7,0	25,0	30	13,0 ~ 18,0
ATMPG29	PG29	8,0	29,0	40	18,0 ~ 25,0
ATMPG36	PG36	8,0	35,0	50	22,0 ~ 32,0
ATMPG42	PG42	9,0	37,0	57	32,0 ~ 38,0
ATMPG48	PG48	10,0	38,0	64	37,0 ~ 44,0





## omniumdata

Nuestra gama Omnium DATA ofrece gabinetes estándar ideales para almacenar y proteger de forma segura equipos de redes, accesorios, interruptores, paneles de conexión, etc. Todos los productos de esta gama se instalan fácilmente y son sencillos de operar y mantener. Proporcionan una solución elegante, robusta y amplia para la red.

*Our DATA range offers standard racks ideal for safely protecting and storing networking equipment, accessories, switches, patch panels, etc. All products in this range are easily installed, operated and maintained providing an elegant, robust and comprehensive networking solution.*

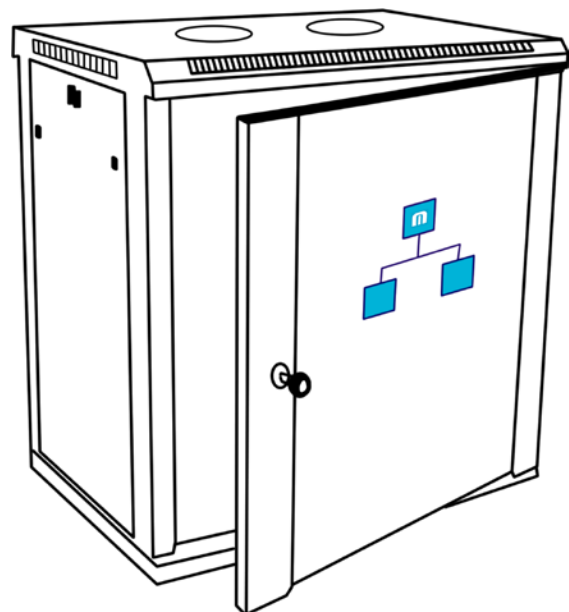

<b>Información técnica</b> <i>Technical information</i>	<b>126</b>
<b>Servidores de torre</b> <i>Standing server cabinets</i>	<b>127</b>
<b>Servidor de pared</b> <i>Wall mount server cabinets</i>	<b>128</b>
<b>Accesorios</b> <i>Accessories</i>	<b>129</b>

**OMNIUM DATA**

**Información técnica**

Los productos de la gama Omnium DATA son fabricados de acuerdo con las siguientes normativas internacionales:

**NSI /EAI RS-310-D, DIN-41491, IEC41494, UNE-EN 60297-3-100**

Compatible con norma internacional 19”, norma métrica y normas ETSI

**Technical information**

Products in the Omnium DATA range conform with the following international standards:

**NSI /EAI RS-310-D, DIN-41491, IEC41494, UNE-EN 60297-3-100**

Compatible with 19” international standard, metric standard & ETSI standards

OD	Tipo de Montaje Installation Type	Unidades Rack Rack Units	Ancho Width		Profundo Depth		Accesorio Gestión de Cableado Cable Management Accessory	
WM	Pared Wall	6U	60	600mm	45	450mm	-	Sin Accesorio Without Accessory
	Esquina Pared Corner Wall	9U	80	800mm	55	550mm	V	Con Gestion de Cableado Vertical With Vertical Cable Management Accessory
	De Pie Standing	12U	90	900mm	60	600mm		
		15U			80	800mm		
		18U			100	1000mm		
		20U						
		22U						
		24U						
		29U						
		33U						
		38U						
		42U						
		47U						



## Servidores de torre / Standing server cabinets

### Información técnica / Equipamento estándar

- Fabricado con SPCC de alta calidad (acero laminado)
- 4 x Railes 19": 2,0mm
- Cuadro: 1,5mm
- Postes Cuadrados: 2,0mm
- 2 x Paneles laterales: 1,0mm (con llave)
- Placa Estantería: 1,2mm
- Tapas para fondo y superiores: 1,2mm
- Cristal templado de alta resistencia: 5mm
- 4 x Soportes M12 de acero, ajustables (galvanizados).
- 4 x 2" Ruedas ajustables de alta resistencia (Ruedas y soportes pueden ser instalados simultáneamente, permitiendo una carga estática de hasta 1000 kg.)
- 4 x Paneles de entrada de cable
- Revestimiento en polvo 80-100µm en conformidad con la normativa RoHS
- 1 x Herramienta TORX

### Technical information / Standard equipment

- Manufactured with high quality SPCC (cold rolled steel)
- 4 x 19" Rails: 2,0mm
- Frame: 1,5mm
- Square Posts: 2,0mm
- 2 x Side Panels: 1,2mm (with lock)
- Shelf Board: 1,2mm
- Top & bottom covers: 1,2mm
- Highly resistant tempered glass: 5mm
- 4 x Adjustable steel (zinc plated) M12 supports
- 4 x 2" Heavy duty casters (Adjustable casters and supports can be installed simultaneously allowing a static load of up to 1000 kg.)
- 4 x Cable entry panels
- Powder coating 80-100µm conforming to RoHS standards
- 1 x TORX tooling



ODSC* ARMARIOS DE PIE / STANDING RACKS						
REFERENCIA REFERENCE	MEDIDAS / MEASUREMENTS			ALTURA HEIGHT	VENTILADORES FAN UNITS	TORNILLOS MONTAJE MOUNTING SCREWS
	Ancho / Width	Profundo / Depth	Alto / Height			
ODSC20U6060	600mm	600mm	1000mm	20U	2	20 Conjuntos / Sets
ODSC20U6080*		800mm			4	
ODSC24U6060	600mm	600mm	1200mm	24U	2	
ODSC24U6080*		800mm			4	
ODSC29U6060	600mm	600mm	1400mm	29U	2	
ODSC29U6080*		800mm			4	
ODSC33U6060	600mm	600mm	1600mm	33U	2	
ODSC33U6080*		800mm			4	
ODSC38U6060	600mm	600mm	1830mm	38U	2	
ODSC38U6080*		800mm			4	
ODSC38U60100*		1000mm			4	
ODSC38U8060	800mm	600mm	1830mm	38U	4	
ODSC38U8080*		800mm			4	
ODSC38U80100*		1000mm			4	
ODSC42U6060	600mm	600mm	2000mm	42U	4	
ODSC42U6080*		800mm			4	
ODSC42U60100*		1000mm			4	
ODSC42U8060*	800mm	600mm	2000mm	42U	4	
ODSC42U8080*		800mm			4	
ODSC42U80100*		1000mm			4	
ODSC47U6080	600mm	600mm	2200mm	47U	4	
ODSC47U6080*		800mm			4	
ODSC47U60100*		1000mm			4	
ODSC47U8080*	800mm	600mm	2200mm	47U	4	
ODSC47U8080*		800mm			4	
ODSC47U80100*		1000mm			4	

Servidor de pared / Wall mount server cabinets

Información técnica / Equipamento estándar

- Fabricado con SPCC de alta calidad (acero laminado)
- 4 x Railes 19": 1,2mm
- Cuadro: 1,2mm
- Postes Cuadrados: 1,5mm
- Perfil de montaje: 1,2mm
- 2 x Paneles laterales: 1,2mm
- Cristal templado de alta resistencia: 5mm
- Revestimiento en polvo 80-100µm en conformidad con la normativa RoHS
- 1 x Herramienta TORX

Technical information / Standard equipment

- Manufactured with high quality SPCC (cold rolled steel)
- 4 x 19" Rails: 1,2mm
- Frame: 1,2mm
- Square Posts: 1,5mm
- Mounting profile: 1,2mm
- 2 x Side Panels: 1,2mm
- Highly resistant tempered glass: 5mm
- Powder coating 80-100µm conforming to RoHS standards
- 1 x TORX tooling



ODWM* ARMARIOS MANTAJE EN PARED / WALL MOUNTED RACKS						
REFERENCIA REFERENCE	MEDIDAS / MEASUREMENTS			ALTURA HEIGHT	VENTILADORES FAN UNITS	TORNILLOS MONTAJE MOUNTING SCREWS
	Ancho / Width	Profundo / Depth	Alto / Height			
ODWM6U6045	600mm	450mm	370mm	6U	2	10 Conjuntos / Sets
ODWM6U6060		600mm			4	
ODWM9U6045	600mm	450mm	500mm	9U	2	
ODWM9U6060		600mm			4	
ODWM12U6045	600mm	450mm	635mm	12U	2	
ODWM12U6060		600mm			4	
ODWM15U6045	600mm	450mm	770mm	15U	4	20 Conjuntos / Sets
ODWM15U6060		600mm			4	
ODWM18U6045	600mm	450mm	900mm	18U	4	
ODWM18U6060		600mm			4	
ODWM22U6045	600mm	450mm	1080mm	22U	4	
ODWM22U6060		600mm			4	
ODWMC* ARMARIOS ESQUINA / CORNER RACKS						
REFERENCIA REFERENCE	MEDIDAS / MEASUREMENTS			ALTURA HEIGHT	VENTILADORES FAN UNITS	TORNILLOS MONTAJE MOUNTING SCREWS
	Ancho / Width	Profundo / Depth	Alto / Height			
ODWMC6U9055	900mm	550mm	370mm	6U	4	10 Conjuntos / Sets
ODWMC9U9055	900mm	550mm	500mm	9U	4	
ODWMC12U9055	900mm	550mm	630mm	12U	4	
ODWMC15U9055	900mm	550mm	770mm	15U	4	20 Conjuntos / Sets



Accesorios / Accessories



Estantería / Cantilever Shelf			
Referencias References	Capacidad Capacity	Profundidad Depth	Carga max. Max. Capacity
ODACS1U07*	1U	177,80mm	V=6kgs / X=9kgs
ODACS1U10*	1U	266,70mm	V=7kgs / X=12kgs
ODACS1U12*	1U	304,80mm	V=9kgs / X=14kgs
ODACS1U15*	1U	381,00mm	V=16kgs / X=18kgs
ODACS2U10*	2U	266,70mm	V=9kgs / X=14kgs
ODACS2U12*	2U	304,80mm	V=11kgs / X=16kgs
ODACS2U15*	2U	381,00mm	V=17kgs / X=20kgs
ODACS2U18X	2U	457,20mm	18kgs
ODACS3U15*	3U	381,00mm	V=20kgs / X=22kgs

\*  
= V (Ventilada/vented)  
= X (No ventilada/non-vented)



Estante deslizable ajustable / Adjustable sliding shelf		
Referencias References	Capacidad Capacity	Profundidad Depth
ODAASS1U14	1U	14"
ODAASS1U26	1U	26"

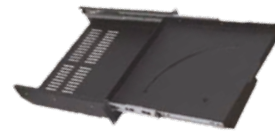

Estante deslizable, mouse y teclado / Sliding keyboard mouse shelf		
Referencias References	Capacidad Capacity	Profundidad Depth
ODAKMTA	2U	18"



Estante porta teclado y mouse / Keyboard with reversible mouse tray		
Referencias References	Capacidad Capacity	Profundidad Depth
ODAKMT	1U	8"



Estante ajustable fijo resistente / Adjustable fixed heavy duty shelf		
Referencias References	Capacidad Capacity	Profundidad Depth
ODAAFHDS1U	1U	26"



Mini estantería voladizo / Cantilever mini shelf		
Referencias References	Capacidad Capacity	Profundidad Depth
ODACMS1U	1U	7"
ODACMS2U	2U	7"

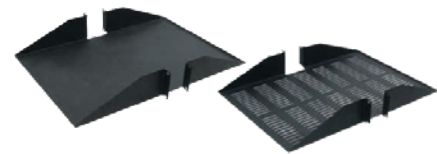

Estantería de doble cara / Double sided shelf		
Referencias References	Capacidad Capacity	Profundidad Depth
ODADSS18	2U	18"
ODADSS25	2U	25"

\*  
= V (Ventilada/vented)  
= X (No ventilada/non-vented)

\*  
= V (Ventilada/vented)  
= X (No ventilada/non-vented)

Accesorios / Accessories



Mini estantería / Cantilever mini shelf				
Referencias References	Capacidad Capacity	Profundidad Depth	D (mm)	Para armarios To racks
ODACSC1U230*	1U	19"	230	Esquina 430mm de profundidad
ODACSC2U230*	2U	19"	230	
ODACSC1U350*	1U	19"	350	Esquina 600mm de profundidad
ODACSC2U350*	2U	19"	350	

\*  
= V (Ventilada/vented)  
= X (No ventilada/non-vented)



Panel de cepillo / Brush panel		
Referencias References	Capacidad Capacity	Profundidad Depth
ODABP1U19	1U	19"



Estantería fija tipo A / Fixed shelf a type			
Referencias References	Ancho Width	Profundidad Depth	Uso use
ODAFSWM300*	489	300	450mm (pared / wall)
ODAFSWM450*	489	450	600mm (pared / wall)
ODAFSSC350*	489	350	600mm (pie / standing)
ODAFSSC550*	489	550	800mm (pie / standing)
ODAFSSC620*	489	620	900mm (pie / standing)
ODAFSSC720*	489	720	1000mm (pie / standing)

\*  
= V (Ventilada/vented)  
= X (No ventilada/non-vented)



Panel ciego / Blank panel		
Referencias References	Capacidad Capacity	Profundidad Depth
ODABP1U*	1U	19"
ODABP2U*	2U	19"
ODABP3U*	3U	19"
ODABP4U*	4U	19"
ODABP5U*	5U	19"
ODABP6U*	6U	19"
ODABP7U*	7U	19"
ODABP8U*	8U	19"

\*  
= V (Ventilada/vented)  
= X (No ventilada/non-vented)



Cajones resistentes / Heavy duty drawers		
Referencias References	Capacidad Capacity	Profundidad Depth
ODAHDD24	2U	19"
ODAHDD3U	3U	19"



Panel de seguridad / Security panel	
Referencias References	Capacidad Capacity
ODASEPAN1U	1U
ODASEPAN2U	2U
ODASEPAN3U	3U

Accesorios / Accessories



ODA1UF2

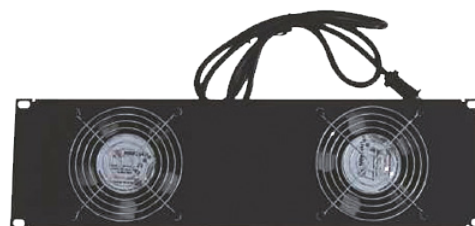

ODA3UF2

Referencias References	Descripción Description	Tipo Type	Capacidad Capacity
ODA1UF2	Conjunto de 2 ventiladores con enchufe en carcasa de acero 2-fan with plug assembly in an steel housing	Bandeja Fan tray	1U
ODA3UF2	Conjunto de 2 ventiladores con enchufe en carcasa de acero 2-fan with plug assembly in an steel housing	Panel Fan Panel	3U



ODAFTU2E / ODAFTU2A



ODAFTU4E / ODAFTU4A



ODADTU4F / ODADTU4FA

Referencias References	Descripción Description	Tipo Type	Dimensiones Dimensions	Observaciones Remark
ODAFTU2E	Unidad con 2 ventiladores y cable de alimentación de 1,5 m Fan Unit with 2 Fan power cord 1.5m, (110-120V)	Americana American	410x370x18mm	Solo apto para gabinetes de 600 mm de ancho Only suitable for 600mm width Cabinet
ODAFTU2A	Unidad con 2 ventiladores y cable de alimentación de 1,5 m Fan Unit with 2 Fan power cord 1.5m, (220-230V)	Europea European	410x370x18mm	
ODAFTU4E	Unidad con 4 ventiladores y cable de alimentación de 1,5 m Fan Unit with 4 Fan power cord 1.5m, (110-120V)	Americana American	568x410x18mm	Solo apto para gabinetes de 800 mm de ancho Only suitable for 800mm width Cabinet
ODAFTU4A	Unidad con 4 ventiladores y cable de alimentación de 1,5 m Fan Unit with 4 Fan power cord 1.5m, (220-230V)	Europea European	568x410x18mm	
ODADTU4F	Unidad con 4 ventiladores y cable de alimentación, con termostato Fan Unit with 4 Fan & Power Cord with thermostat, (110-120V)	Americana American		
ODADTU4FA	Unidad con 4 ventiladores y cable de alimentación, con termostato Fan Unit with 4 Fan & Power Cord with thermostat, (220-230V)	Europea European		



ODAHLK



ODAKL



ODACNS



ODASCK10-32



ODASCK12-24

Referencias References	Descripción Description	Información adicional Additional information
ODAHLK	Cerradura con asa cómoda Lock with comfort handle	Espesor de la cerradura / Thickness of lock: 30mm Tamaño del agujero / Hole size: 126x24,5 mm
ODAKL	Cerradura pequeña Small lock	Espesor de la cerradura / Thickness of lock: 20mm Tamaño del agujero / Hole size: Ø 19x16,5 mm
ODACNS	Kit de Tornillo M6 con tuerca enjaulada y arandela de nailon M6 screw kit with cage nut & nylon washer	-----
ODASCK10-32	Kit de tornillo 10-32 con arandela de nailon 10-32 screw kit with nylon washer	-----
ODASCK12-24	Kit de tornillo 12-24 con tuerca enjaulada y arandela de nailon 12-24 screw kit with cage nut & nylon washer	-----

Accesorios / Accessories



ODSC-AF1



ODSC-CASA



ODSC-CASB

Referencias References	Descripción Description	Capacidad de carga estática Static load capacity
ODSC-AF1	Pies ajustables M12, kit de 4 piezas M12 adjustable feet, 4-piece kit	250kg
ODSC-CASA	Rueda 2.0", Kit de 4 piezas Castor, 4-piece kit	250kg
ODSC-CASB	Rueda 2.0" con freno, kit de 4 piezas Castor with braking, 4-piece kit	250kg



ODAPCMB1U



ODAPCMBDS



ODACMBDSC



ODAPCMB24

Referencias References	Descripción Description	Profundidad Depth
ODAPCMB1U	Organizador de cables de plástico Plastic Cable management	19"
ODAPCMBDS	Organizador de cables de plástico, doble cara Plastic Cable management, double side	19"
ODACMBDSC	Organizador de cables, barra de acero, anillos de plástico y tapa, doble cara Cable management, steel bar, plastic rings and cover, double side	19"
ODAPCMB24	Organizador de cables de plástico Plastic Cable management	19"



ODACM1



ODACM2



ODACM3



ODACM4

Referencias References	Descripción Description	Profundidad Depth	Capacidad Capacity
ODACM1	Organizador de cables Cable management	19"	1U
ODACM2	Organizador de cables Cable management	19"	2U
ODACM3	Organizador de cables Cable management	19"	1U
ODACM4	Organizador de cables con cepillo Cable management with brush	19"	1U

Accesorios / Accessories



ODAPPUTP24-03



ODAPPUTP24-07



ODAPPUTP24-08



ODAPPUTP24-10



FODAPPUTP24-12

Referencias References	Descripción Description	Categoría Category
ODAPPUTP24-03	Panel de conexión de 24 puertos UTP UTP 24 port patch panel	Cat. 5e / Cat 6 / Cat. 6A
ODAPPUTP24-07	Panel de conexión de 24 puertos UTP UTP 24 port patch panel	Cat. 6A
ODAPPUTP24-08	Panel de conexión de 24 puertos UTP UTP 24 port patch panel	Cat. 6A
ODAPPUTP24-10	Panel de conexión de 24 puertos UTP, Krone y 110 dual IDC UTP 24 port patch panel	Cat. 5e
ODAPPUTP24-12	Panel de conexión de 24 puertos UTP, Krone y 110 dual IDC UTP 24 port patch panel	Cat. 5e

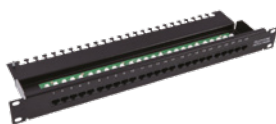

ODAPPTEL-15



ODAPPUTP48-18



ODAPPSTP24-22



ODAPPUTP96-23

Referencias References	Descripción Description	Cant. Puertos Ports number
ODAPPTEL-15	Panel de conexión telefónico Telephone patch panel	25
ODAPPUTP48-18	Panel de conexión UTP Cat. 5e / Cat. 6, UTP Cat. 5e / Cat. 6 patch panel	48
ODAPPSTP24-22	Panel de conexión STP Cat. 6 STP Cat. 6 patch panel	24
ODAPPUTP96-23	Panel de conexión UTP Cat. 5e / Cat. 6, UTP Cat. 5e / Cat. 6 patch panel	96



ODASWSP8



ODASWSP6



ODASWSP9A



ODASWSP8A

Referencias References	Descripción Description	Tipo Type
ODASWSP8	Multicontacto Schuko 8 tomas, 16A, 250V Schuko multicontact 8 sockets	Europea European
ODASWSP6	Multicontacto Schuko 6 tomas, 16A, 250V Schuko multicontact 6 sockets	Europea European
ODASWSP9A	Multicontacto 9 tomas, 16A, 250V Multi contact 9 sockets	Americano American
ODASWSP8A	Multicontacto 8 tomas, 16A, 250V Multi contact 8 sockets	Americano American





## omnifix

Omnifix ofrece una gama de productos de fijación, relacionados con las instalaciones eléctricas, de alta calidad. La gama incluye bridas de nylon, tacos de pared, clips para la sujeción de cable, etc..

*Omnifix offers a high quality range of fixing products related to electrical installations, including nylon cable ties, wall plugs, cable clips, etc..*

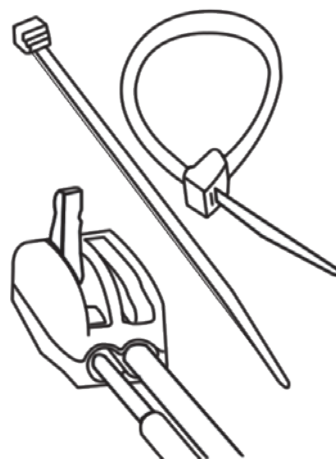

<b>Bridas</b> <i>Cable ties</i>	136
<b>Base bidireccional con adhesivo</b> <i>Self adhesive tie mounts</i>	139
<b>Identificadores de cables</b> <i>Cable tags</i>	139
<b>Taco de brida</b> <i>Cable tie holder</i>	139
<b>Bloques de conexión reutilizable</b> <i>Cage clamp reusable wire connector</i>	140
<b>Regleta de conexión tipo H y tipo U</b> <b>H and U Type</b> <i>electrical connection strips</i>	141
<b>Punteras huecas aisladas</b> <i>Insulated end sleeves</i>	142
<b>Copper tube cable lugs</b> <i>Terminales tubo de cobre</i>	143
<b>Conectores de cable de rosca</b> <i>Twist wire connectors</i>	143
<b>Marcadores de cable y accesorios</b> <i>Cable markers and accessories</i>	144

Bridas de Nylon / Nylon Cable Ties

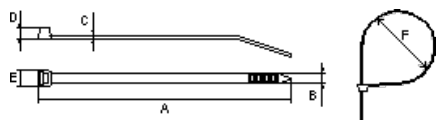

\* = Reemplazar con / Replace with:  
B = para color Negro / for Black  
W = para Blanco / for White  
Otras medidas disponibles bajo pedido  
Other sizes available upon request

Referencias References	Medidas / Dimensions (mm)									Kg
	Ancho Width	Largo Length	Pulgadas Inches	A	B	C	D	E	F	
OF2.5060*	2,2	60	2,4"	60	2,2	1,00	3,40	4,35	11	8
OF2.5080*	2,2	80	3,2"	80	2,2	1,00	3,40	4,35	15	8
OF2.5100*	2,5	100	4"	100	2,5	1,00	3,45	4,35	22	8
OF2.5120*	2,5	120	4,7"	120	2,5	1,10	3,55	4,60	30	8
OF2.5150*	2,5	150	6"	150	2,5	1,10	3,50	4,55	35	8
OF2.5200*	2,5	200	8"	200	2,5	1,10	3,50	4,50	53	8
OF3.6120*	3,6	120	4,7"	120	3,6	1,20	4,30	6,05	30	18
OF3.6140*	3,6	140	5,5"	140	3,6	1,30	4,30	6,05	33	18
OF3.6150*	3,6	150	6"	150	3,6	1,30	4,30	6,05	35	18
OF3.6180*	3,6	180	7,2"	180	3,6	1,30	4,45	6,20	44	18
OF3.6200*	3,6	200	8"	200	3,6	1,30	4,35	6,10	53	18
OF3.6250*	3,6	250	10"	250	3,6	1,35	4,50	6,15	65	18
OF3.6300*	3,6	300	12"	300	3,6	1,35	4,40	6,15	76	18
OF3.6370*	3,6	370	14"	370	3,6	1,35	4,50	6,15	102	18
OF4.8120*	4,8	120	4,7"	120	4,8	1,35	4,60	7,55	24	22
OF4.8150*	4,8	150	6"	150	4,8	1,35	5,55	7,25	35	22
OF4.8180*	4,8	180	7,2"	180	4,8	1,35	5,25	7,65	46	22
OF4.8200*	4,8	200	8"	200	4,8	1,35	5,25	7,65	50	22
OF4.8250*	4,8	250	10"	250	4,8	1,45	5,35	7,65	60	22
OF4.8280*	4,8	280	11"	280	4,8	1,45	5,75	7,55	70	22
OF4.8300*	4,8	300	12"	300	4,8	1,45	5,75	7,55	76	22
OF4.8350*	4,8	350	14"	350	4,8	1,45	6,10	7,80	83	22
OF4.8380*	4,8	380	15"	380	4,8	1,45	5,00	7,10	102	22
OF4.8400*	4,8	400	16"	400	4,8	1,45	5,85	7,60	105	22
OF4.8430*	4,8	430	17"	430	4,8	1,45	5,90	7,50	110	22
OF4.8450*	4,8	450	18"	450	4,8	1,45	5,90	7,50	116	22
OF4.8500*	4,8	500	20"	500	4,8	1,45	5,90	7,50	145	22
OF6.3200*	6,3	200	8"	200	6,3	1,3	7,20	10,50	50	38
OF6.3250*	6,3	250	10"	250	6,3	1,35	7,10	10,40	65	38
OF6.5300*	6,5	300	12"	300	6,5	1,50	6,90	10,90	76	38
OF6.5350*	6,5	350	14"	350	6,5	1,50	6,60	11,50	83	38
OF7.5200*	7,5	200	8"	200	7,5	1,70	7,10	12,10	50	55
OF7.5250*	7,5	250	10"	250	7,5	1,70	7,10	12,10	65	55
OF7.5300*	7,5	300	12"	300	7,5	1,60	7,00	11,70	76	55
OF7.5350*	7,5	350	14"	350	7,5	1,60	7,00	11,70	83	55
OF7.5380*	7,5	380	15"	380	7,5	1,70	7,20	12,60	102	55
OF7.5400*	7,5	400	16"	400	7,5	1,70	7,20	12,60	105	55
OF7.5450*	7,5	450	18"	450	7,5	1,70	7,20	11,70	116	55
OF7.5500*	7,5	500	20"	500	7,5	1,70	7,20	11,70	132	55
OF7.5550*	7,5	550	21,6"	550	7,5	1,80	7,20	11,70	145	55
OF7.5760*	7,5	760	30"	760	7,5	1,90	7,50	13,00	228	55
OF9.0400*	9,0	400	16"	400	9	1,90	8,10	13,50	105	80
OF9.0450*	9,0	450	18"	450	9	1,90	8,10	13,50	116	80
OF9.0500*	9,0	500	20"	500	9	1,90	8,10	13,50	132	80
OF9.0550*	9,0	550	21,6"	550	9	1,90	8,10	13,50	145	80
OF9.0650*	9,0	650	26"	650	9	1,90	8,10	13,50	178	80
OF9.0700*	9,0	700	28"	700	9	1,90	8,10	13,50	205	80
OF9.0760*	9,0	760	30"	760	9	1,90	8,10	13,50	225	80
OF9.0920*	9,0	920	36"	920	9	2,10	8,20	13,50	263	80
OF9.01020*	9,0	1020	40"	1020	9	2,10	8,20	13,50	295	80
OF9.01220*	9,0	1220	48"	1220	9	2,10	9,30	14,60	340	80
OF9.60450*	9,6	450	18"	450	9,6	2,10	9,30	15,10	116	200
OF9.60500*	9,6	500	20"	500	9,6	2,10	9,30	15,10	132	200
OF12650*	12,0	650	26"	650	12	2,10	11,50	17,10	178	250

### Bridas reapertura multiuso / Bead Cable ties

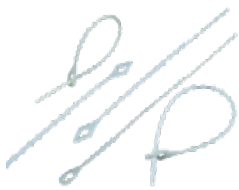

Referencias References	Medidas / Dimensions (mm)						Kg
	Ancho Width	Largo Length	Pulgadas Inches	A	B	F	
OFB5.08100*	5,08	100	3,94"	100	5,08	25	8
OFB5.08120*	5,08	120	4,72"	120	5,08	30	8
OF9.65150*	9,65	150	5,91"	150	9,65	39	14

### Bridas con ojal / Mountable head ties

Se puede sujetar con un único tornillo  
Can be secured with a single screw

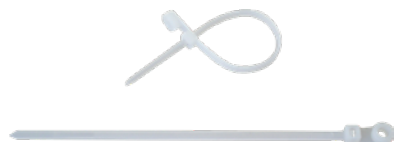

Referencias References	Medidas / Dimensions (mm)						Tamaño Tornillo Screw size	Kg
	Ancho Width	Largo Length	Pulgadas Inches	A	B	F		
OFB5.08100*	3,2	135	5,51"	135	3,2	32	4,2	18
OFB5.08120*	4,0	200	7,87"	200	4,0	50	4,2	18
OF9.65150*	4,8	200	7,87"	200	4,8	50	5,5	22

### Bridas Recuperables / Releasable cable ties

Permite una rápida sujeción y retirada de cableado  
Allows for quick fastening and removal of cables



Referencias References	Medidas / Dimensions (mm)						Kg
	Ancho Width	Largo Length	Pulgadas Inches	A	B	F	
OFR7.6150*	7,6	150	5,91"	150	7,6	35	22
OFR7.6200*	7,6	200	7,87"	200	7,6	50	22
OFR7.6250*	7,6	250	9,84"	250	7,6	66	22
OFR7.6300*	7,6	300	11,81"	300	7,6	80	22
OFR7.6350*	7,6	350	14,57"	350	7,6	102	22

### Bridas de doble cierre / Double locking cable ties

Alta capacidad de soporte  
Strong supporting capacity



Referencias References	Medidas / Dimensions (mm)						Kg
	Ancho Width	Largo Length	Pulgadas Inches	A	B	F	
OFD7.8210*	7,8	210	8"	210	7,8	35	35
OFD9.0180*	9,0	180	7"	180	9,0	46	35
OFD9.0260*	9,0	260	10,65"	260	9,0	50	50

### Bridas de montaje / Push mount ties

Injerto con acoplador fácil  
With easy panel insert



Referencias References	Medidas / Dimensions (mm)						Kg
	Ancho Width	Largo Length	Pulgadas Inches	A	B	F	
OFP4.8200*	4,8	200	7,87"	200	4,8	46	18
OFP7.5150*	7,5	150	6,0"	150	7,5	35	22
OFP7.5175*	7,5	175	7,09"	175	7,5	46	22
OFP8.0220*	8,0	220	8,8"	220	8,0	48	22

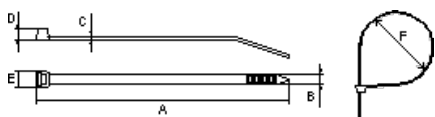

\* = Reemplazar con / Replace with:  
B = para color Negro / for Black  
W = para Blanco / for White

Otras medidas disponibles bajo pedido  
Other sizes available upon request

### Bridas con etiqueta / Marker ties

Permite la sujeción e identificación del cableado  
Allows for fastening and identification of bundled cables

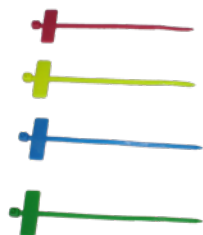

Referencias References	Medidas / Dimensions (mm)						Tamaño Etiqueta Marker size (mm)	Kg
	Ancho Width	Largo Length	Pulgadas Inches	A	B	F		
OFMT100.08*	2,5	100	4"	100	2,5	22	25x8	8
OFMT100.10*	2,5	100	4"	100	2,5	22	21x10	8
OFMT150.15*	3,2	150	6"	150	3,2	35	25x15	18
OFMT200.15*	3,2	200	8"	200	3,2	52	25x15	18

\* = Reemplazar con / Replace with:  
B = para Azul / for Blue - G = para Verde / for Green - R = para Rojo / for Red  
- Y = para Amarillo / for Yellow

### Bridas de acero inoxidable / Stainless steel cable ties

Alta resistencia. Temperatura operativa: -80°C ~ +500°C. Grosor 0,25mm  
High resistance. Operating temperature: -80°C ~ +500°C. Thickness 0,25mm



Referencias References	Medidas / Dimensions (mm)				
	Ancho Width	Largo Length	A	B	F
OFS4.6100	4,6	100	100	4,6	23
OFS4.6150	4,6	150	150	4,6	38
OFS4.6200	4,6	200	200	4,6	52
OFS4.6250	4,6	250	250	4,6	68
OFS4.6300	4,6	300	300	4,6	84
OFS4.6350	4,6	350	350	4,6	103
OFS4.6500	4,6	500	500	4,6	148
OFS8.01000	8,0	1000	1000	8,0	307
OFS8.01100	8,0	1100	1100	8,0	338
OFS8.01200	8,0	1200	1200	8,0	371
OFS8.01300	8,0	1300	1300	8,0	403
OFS8.01400	8,0	1400	1400	8,0	434

Otras medidas disponibles bajo pedido  
Other sizes available upon request

### Bridas de nylon (con lengüeta metálica) / nylon cable ties (with stainless steel plate lock)

Alta resistencia. Temperatura operativa: -25°C ~ +60°C. Alto nivel de aislamiento.  
High resistance. Operating temperature: -25°C ~ +60°C. High insulation level.

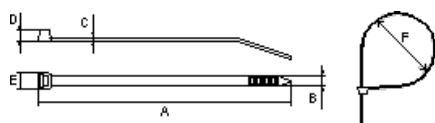

Referencias References	Medidas / Dimensions (mm)					Fuerza max. Max. Force (N)
	Ancho Width	Largo Length	A	B	F	
OFN3.0100*	3,0	100	100	3,0	25	50
OFN4.0150*	4,0	150	150	4,0	35	150
OFN4.0200*	4,0	200	200	4,0	50	150
OFN8.0145*	8,0	145	145	8,0	35	250
OFN8.0175*	8,0	175	175	8,0	45	250
OFN8.0200*	8,0	200	200	8,0	50	250
OFN8.0240*	8,0	240	240	8,0	60	250
OFN10.0300*	10,0	300	300	10,0	80	500
OFN10.0350*	10,0	350	350	10,0	95	500
OFN10.0400*	10,0	400	400	10,0	110	500
OFN10.0450*	10,0	450	450	10,0	130	500
OFN10.0550*	10,0	550	550	10,0	160	500

\* = Reemplazar con / Replace with:  
B = Negro / Black  
W = Blanco / White



### Base bidireccional con adhesivo / Self-Adhesive tie mounts

Permite la fijación donde no son posibles las perforaciones  
Allows for fastning where drilling or nailing is not possible

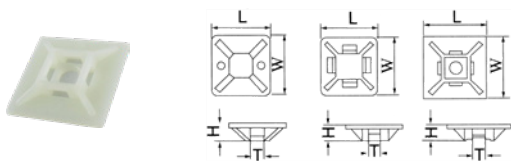

Referencias References	Medidas / Dimensions (mm)						Tamaño de brida Cable tie size (mm)
	Ancho Width	Largo Length	W	L	H	T	
OFSA2020A	20	20	20	20	6,1	5,0	2,9
OFSA2525A	25	25	25	25	7,5	6,2	3,5
OFSA3030A	30	30	30	30	8,7	6,4	4,5
OFSA4040A	40	40	40	40	11,5	10,8	/
OFSA1919B	20	20	20	20	6,1	5,0	2,9
OFSA2828C	30	30	30	30	8,7	6,4	4,5

### Identificadores de cables / Cable tags

Para la identificación de cableado  
For the identification of bundled cables



Referencias References	Medidas / Dimensions (mm)				Tamaño de brida (grueso x ancho) Cable tie size (thickness x width) (mm)
	Ancho Width	Largo Length	W	L	
OFCT2456R	24	56	24	56	3,0 x 9,0
OFCT3271F	32	71	32	71	2,5 x 5,0

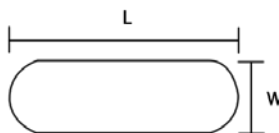

### Taco de brida / Cable tie holder

Taco de pared para uso con brida  
Wall plug for use with cable ties



Referencias References	Medidas / Dimensions (mm)				
	H	H1	W	L	L1
OF8CTH	37	6,0	10	12,7	9,7

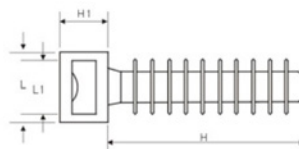

**Bloque de conexión reutilizable / Cage clamp wire connectors**

Diseñados para la conexión de cables - re-utilizables, 0-400V AC  
Designed for reusable wiring connections, 0-400V AC



Referencias References	Vías Entries	Rango cable Wire range mm <sup>2</sup>	Rango de cable flexible Flexible core cable range mm <sup>2</sup>	I <sub>max</sub> .
OFBCC02	2	0,08 ~ 2,5	0,08 ~ 4,0	32A
OFACC03	3	0,08 ~ 2,5	0,08 ~ 4,0	32A
OFACC05	5	0,08 ~ 2,5	0,08 ~ 4,0	16A



Referencias References	Vías Entries	Rango cable Wire range mm <sup>2</sup>	Rango de cable flexible Flexible core cable range mm <sup>2</sup>	I <sub>max</sub> .
OFBCC02	2	0,08 ~ 2,5	0,08 ~ 4,0	32A
OFACC03	3	0,08 ~ 2,5	0,08 ~ 4,0	32A
OFACC04	4	0,08 ~ 2,5	0,08 ~ 4,0	32A
OFACC05	5	0,08 ~ 2,5	0,08 ~ 4,0	16A

CE UNE-EN 60998-1  
RoHS

**Conectores de cable de rosca / Twist wire connectors**

Conector rosca, con buena resistencia a altas temperaturas e impactos  
Twist connector with good resistance to high temperatures and impacts

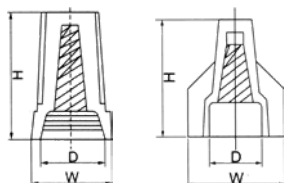

Referencias References	Medidas / Dimensions (mm)			Rango de cable Wire range	Color Colour
	H	W	D		
OFSTC12	18,0	10,0	7,5	1,0 ~ 1,5mm <sup>2</sup>	Azul / Blue
OFSTC13	23,0	11,2	9,5	1,5 ~ 2,5mm <sup>2</sup>	Naranja / Orange
OFSTC14	24,2	13,6	10,8	2,5 ~ 4,0mm <sup>2</sup>	Amarillo / Yellow
OFSTC15	27,8	16,1	12,7	4,0 ~ 8,0mm <sup>2</sup>	Rojo / Red
OFSTC16	32,0	18,0	14,0	8,0 ~ 16,0mm <sup>2</sup>	Gris / Grey
OFSTC21	22,0	19,0	9,8	4,0 ~ 8,0mm <sup>2</sup>	Amarillo / Yellow

CE UNE-EN 60998-1  
RoHS

## Regleta de conexión tipo H / H type wiring connectors

Voltaje: 250 ~ 450V.  
Disponible en PE (-40°C ~ +65°C), PP (-20°C ~ +90°C), y PA (-30°C ~ +110°C)

Voltage: 250 ~ 450V.  
Available in PE (-40°C ~ +65°C), PP (-20°C ~ +90°C), y PA (-30°C ~ +110°C)

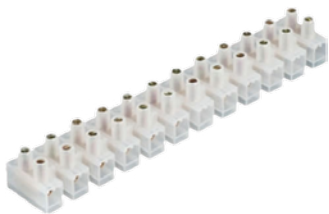

\* = Reemplazar con / Replace with:  
1 = PE - 2 = PP - 3 = PA

\*\* = Reemplazar con / Replace with:  
B = para color Negro / for Black  
W = para color Blanco / for White

Referencias References	Espec. Spec.	Medidas / Dimensions (mm)							Medida tornillo Screw size
		L	W	H <sub>1</sub>	H <sub>2</sub>	ø	E <sub>1</sub>	E <sub>2</sub>	
OFWC*H04**	3A 4mm <sup>2</sup>	92,3	16,8	12,3	7,7	3,0	7,8	5,7	M2,5 x 4
OFWC*H06**	6A 6mm <sup>2</sup>	115,4	18,8	15,4	8,7	3,2	9,6	6,3	M3 x 5
OFWC*H10**	10A 10mm <sup>2</sup>	129,3	20,7	16,0	9,5	4,2	11,0	7,6	M3 x 6
OFWC*H12**	15A 12mm <sup>2</sup>	137,8	22,5	18,6	10,3	4,5	11,7	8,6	M3 x 7
OFWC*H14**	20A 14mm <sup>2</sup>	138,0	22,5	19,0	10,7	4,7	12,0	8,6	M4 x 6,5
OFWC*H16**	30A 16mm <sup>2</sup>	164,0	22,5	20,0	11,7	5,6	13,7	9,3	M4 x 7
OFWC*H25**	60A 25mm <sup>2</sup>	186,0	29,2	25,3	14,8	6,6	15,7	10,8	M4 x 9
OFWC*H35**	80A 35mm <sup>2</sup>	226,8	36,1	29,0	18,0	7,8	19,2	13,2	M5 x 11
OFWC*H40**	100A 40mm <sup>2</sup>	254,6	45,0	34,7	22,3	9,0	20,5	19,2	M6 x 12

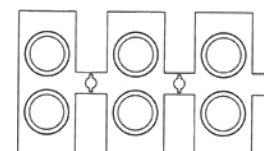
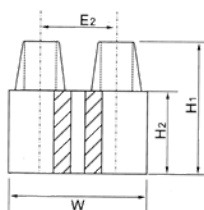
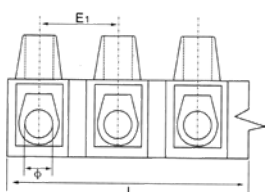

UNE-EN 60998-1  
RoHS

## Regleta de conexión tipo U / U type wiring connectors

Voltaje: 250 ~ 450V.  
Disponible en PE (-40°C ~ +65°C), PP (-20°C ~ +90°C), y PA (-30°C ~ +110°C)

Voltage: 250 ~ 450V.  
Available in PE (-40°C ~ +65°C), PP (-20°C ~ +90°C), y PA (-30°C ~ +110°C)



\* = Reemplazar con / Replace with:  
1 = PE - 2 = PP - 3 = PA

\*\* = Reemplazar con / Replace with:  
B = para color Negro / for Black  
W = para color Blanco / for White

Referencias References	Espec. Spec.	Medidas / Dimensions (mm)							Medida tornillo Screw size
		L	W	H <sub>1</sub>	H <sub>2</sub>	ø	E <sub>1</sub>	E <sub>2</sub>	
OFWC*U04**	3A 4mm <sup>2</sup>	91,4	15,6	10,8	6,4	3,0	7,5	5,8	M2,5 x 4
OFWC*U06**	6A 6mm <sup>2</sup>	112,5	16,0	12,8	7,5	3,2	9,5	6,2	M3 x 4,5
OFWC*U10**	10A 10mm <sup>2</sup>	128,0	20,6	15,0	8,6	4,2	10,8	7,3	M3 x 6
OFWC*U12**	15A 12mm <sup>2</sup>	137,3	22,5	16,6	9,0	4,5	11,5	8,1	M3 x 7
OFWC*U14**	20A 14mm <sup>2</sup>	137,5	22,0	17,7	9,9	4,7	12,0	8,4	M4 x 6,5
OFWC*U16**	30A 16mm <sup>2</sup>	164,5	25,3	19,0	10,7	5,6	19,0	9,3	M4 x 7
OFWC*U25**	60A 25mm <sup>2</sup>	185,5	29,2	24,0	13,3	6,6	15,8	13,0	M4 x 9
OFWC*H35**	80A 35mm <sup>2</sup>	204,5	32,6	27,2	14,0	7,0	17,3	14,8	M5 x 11
OFWC*U40**	100A 40mm <sup>2</sup>	250,0	45,6	30,6	18,0	8,8	21,5	21,6	M6 x 12

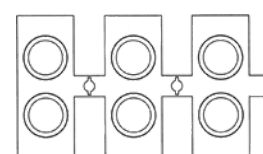
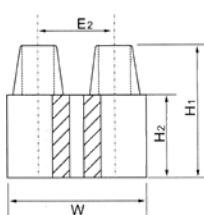
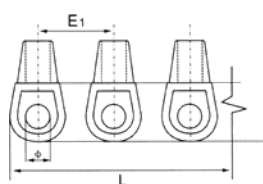

UNE-EN 60998-1  
RoHS

**Punteras huecas aisladas en polipropileno / Polypropylene insulated end sleeves**

Fabricadas en cobre electrolítico estañado. Diseñadas para reforzar la flexibilidad del cable en la conexión con regletas  
Manufactured with tin plated electrolytic copper. Connector designed to reinforce fine wire strands when terminating a cable

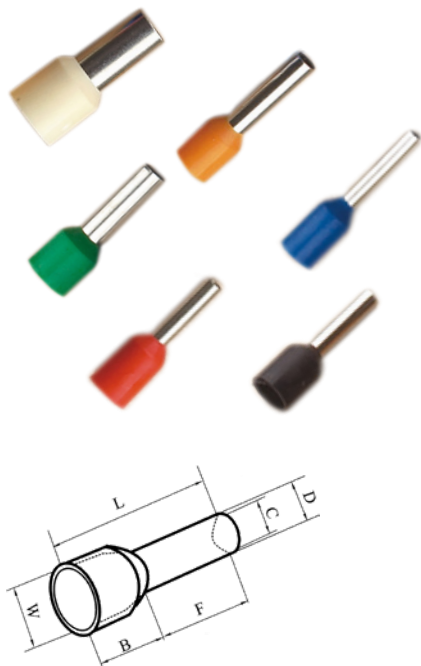

- Añadir / Add:
- <sup>1</sup> - N = para Naranja/for Orange - W = para Blanco/for White
  - <sup>2</sup> - W = para Blanco/for White - A = para Azul/for Blue
  - <sup>3</sup> - Y = para Amarillo/for Yellow - R = para Rojo/for Red
  - <sup>4</sup> - R = para Rojo/for Red - B = para Negro/for Black
  - <sup>5</sup> - A = para Azul/for Blue - G = para Gris/for Grey
  - <sup>6</sup> - G = para Gris/for Grey - N = para Naranja/for Orange
  - <sup>7</sup> - B = para Negro/for Black - V = para Verde/for Green
  - <sup>8</sup> - C = para Crema/for Cream - M = para Marrón/for Brown
  - <sup>8</sup> - V = para Verde/for Green
  - <sup>9</sup> - V = para Verde/for Green - C = para Crema/for Cream
  - <sup>10</sup> - M = para Marrón/for Brown - V = para Verde/for Green
  - <sup>10</sup> - B = para Negro/for Black

Referencias References	Medidas / Dimensions (mm)						Cable Cable mm <sup>2</sup>	Color Colour
	F	L	W	B	D	C		
OFIS06 <sup>2</sup>	8,0	14,6	2,8	6,4	1,5	1,2	0,75	Blanco/Azul White/Blue
OFIS07 <sup>2</sup>	10,0	16,4	2,8	6,4	1,5	1,2	0,75	
OFIS08 <sup>2</sup>	12,0	18,4	2,8	6,4	1,5	1,2	0,75	
OFIS09 <sup>2</sup>	18,0	24,4	2,8	6,4	1,5	1,2	0,75	Amarillo/Rojo Yellow/Red
OFIS10 <sup>3</sup>	6,0	12,4	3,0	6,4	1,7	1,4	1,0	
OFIS11 <sup>3</sup>	8,0	14,6	3,0	6,4	1,7	1,4	1,0	
OFIS12 <sup>3</sup>	10,0	16,4	3,0	6,4	1,7	1,4	1,0	Rojo/Negro Red/Black
OFIS13 <sup>3</sup>	12,0	18,4	3,0	6,4	1,7	1,4	1,0	
OFIS14 <sup>4</sup>	8,0	14,6	3,5	6,4	2,0	1,7	1,5	
OFIS15 <sup>4</sup>	10,0	16,4	3,5	6,4	2,0	1,7	1,5	Azul/Gris Blue/Grey
OFIS16 <sup>4</sup>	18,0	24,4	3,5	6,4	2,0	1,7	1,5	
OFIS17 <sup>5</sup>	8,0	15,2	4,0	7,0	2,6	2,3	2,5	
OFIS18 <sup>5</sup>	12,0	19,0	4,0	7,0	2,6	2,3	2,5	Gris/Naranja Grey/Orange
OFIS19 <sup>5</sup>	18,0	25,0	4,0	7,0	2,6	2,3	2,5	
OFIS20 <sup>6</sup>	9,0	16,5	4,4	7,5	3,2	2,8	4,0	
OFIS21 <sup>6</sup>	12,0	19,5	4,4	7,5	3,2	2,8	4,0	Negro/Verde Black/Green
OFIS22 <sup>6</sup>	18,0	25,5	4,4	7,5	3,2	2,8	4,0	
OFIS23 <sup>7</sup>	12,0	20,0	6,3	8,0	3,9	3,5	6,0	
OFIS24 <sup>7</sup>	18,0	26,0	6,3	8,0	3,9	3,5	6,0	Crema/Marrón/Verde Cream/Brown/Green
OFIS25 <sup>8</sup>	12,0	21,5	7,6	9,5	4,9	4,5	10,0	
OFIS26 <sup>8</sup>	18,0	27,5	7,6	9,5	4,9	4,5	10,0	
OFIS27 <sup>9</sup>	12,0	22,2	8,8	10,2	6,2	5,8	16,0	Verde/Crema Green/Cream
OFIS28 <sup>9</sup>	18,0	28,2	8,8	10,2	6,2	5,8	16,0	
OFIS29 <sup>10</sup>	16,0	29,0	11,2	13,0	7,9	7,5	25,0	Marrón/Verde/Negro Brown/Green/Black
OFIS30 <sup>10</sup>	22,0	35,0	11,2	13,0	7,9	7,5	25,0	
OFIS31	16,0	30,0	12,7	14,0	8,7	8,3	35,0	Marrón/Brown
OFIS32	25,0	39,0	12,7	14,0	8,7	8,3	35,0	
OFIS33	20,0	36,0	15,3	16,0	10,9	10,3	50,0	
OFIS34	25,0	41,0	15,3	16,0	10,9	10,3	50,0	

**Punteras de doble cable / Twin cord end sleeves**

Fabricadas en cobre electrolítico estañado. Diseñadas para reforzar la flexibilidad del cable en la conexión con regletas  
Manufactured with tin plated electrolytic copper. Connector designed to reinforce fine wire strands when terminating a cable

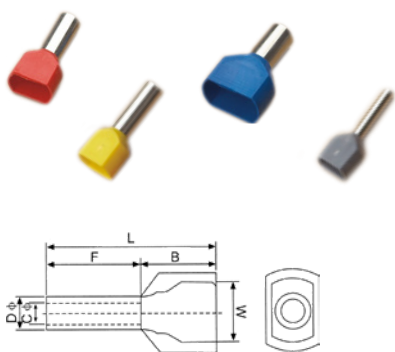

- Añadir / Add:
- <sup>1</sup> - N = para Naranja/for Orange - G = para Gris/for Grey
  - <sup>2</sup> - V = para Verde/for Green - Y = para Amarillo/for Yellow
  - <sup>3</sup> - M = para Marrón/for Brown - G = para Gris/for Grey
  - R = para Rojo/for Red
  - <sup>4</sup> - C = para Crema/for Cream - W = para Blanco/for White

Referencias References	Conductor Conductor mm <sup>2</sup>	Medidas / Dimensions (mm)						Color Colour
		F	L	W	B	D <sub>ø</sub>	C <sub>ø</sub>	
OFTCS04	2,0 x 1,0	8,0	15,1	5,5	7,1	2,3	2,0	Rojo/Red
OFTCS06	2,0 x 1,5	8,0	15,5	6,4	7,2	2,6	2,3	Negro/Black
OFTCS07	2,0 x 1,5	12,0	19,5	6,4	7,5	2,6	2,3	Negro/Black
OFTCS08	2,0 X 2,5	10,0	18,5	8,0	8,5	3,3	2,9	Gris/Grey
OFTCS09	2,0 X 2,5	13,0	21,5	8,0	8,5	3,3	2,9	Azul/Blue
OFTCS10 <sup>1</sup>	2,0 X 4,0	12,0	23,1	8,8	11,1	4,2	3,8	Naranja/Gris Orange/Grey
OFTCS11 <sup>2</sup>	2,0 x 6,0	14,0	26,1	9,5	12,1	5,3	4,9	Verde/Amarillo Green/Yellow
OFTCS12 <sup>3</sup>	2,0 x 10,0	14,0	26,6	12,6	12,0	6,9	6,5	Marrón/Verde/Rojo Brown/Green/Red
OFTCS13 <sup>4</sup>	2,0 x 16,0	14,0	31,3	19,0	17,3	8,7	8,3	Crema/Blanco Cream/White



## Terminales de tubo de cobre / Copper tube cable lugs

Terminales diseñadas para uso en aplicaciones de alto voltaje y resistencia  
Terminal lugs designed for high voltage and resistance applications

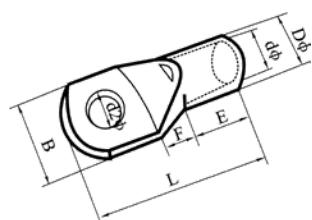

Referencias References	Medidas / Dimensions (mm)					
	dø	dø	Dø	B	E	L
OFCTL01	5,2	1,8	3,7	8,0	6,5	16,0
OFCTL02	4,2	2,4	4,0	8,0	7,0	18,0
OFCTL03	5,2	2,4	4,0	10,0	7,0	20,0
OFCTL04	5,2	3,1	4,8	10,0	7,5	20,0
OFCTL05	6,5	3,1	4,8	10,0	7,5	20,0
OFCTL06	5,2	3,8	5,5	10,0	8,0	23,0
OFCTL07	6,5	3,8	5,5	12,0	8,0	23,0
OFCTL08	6,5	4,5	6,2	12,0	9,0	25,0
OFCTL09	8,4	4,5	6,2	12,0	9,0	25,0
OFCTL10	6,5	5,4	7,1	12,0	11,0	30,0
OFCTL11	8,4	5,4	7,1	12,0	11,0	30,0
OFCTL12	6,5	6,8	8,8	13,0	13,5	33,0
OFCTL13	8,4	6,8	8,8	18,0	13,5	33,0
OFCTL14	8,4	8,2	10,6	15,3	14,5	38,0
OFCTL15	10,5	8,2	10,6	18,0	14,5	38,0
OFCTL16	8,4	9,5	12,4	17,8	17,0	45,0
OFCTL17	10,5	9,5	12,4	17,8	17,0	45,0
OFCTL18	10,5	11,2	14,7	21,0	19,5	50,0
OFCTL19	13,0	11,2	14,7	21,0	19,5	50,0
OFCTL20	10,5	13,5	17,4	25,0	23,5	55,0
OFCTL21	13,0	13,5	17,4	25,0	23,5	55,0
OFCTL22	13,0	15,0	19,4	28,0	26,0	63,0
OFCTL23	17,0	15,0	19,4	28,0	26,0	63,0
OFCTL24	13,0	16,5	21,2	30,0	29,0	70,0
OFCTL25	17,0	16,5	21,2	30,0	29,0	70,0
OFCTL26	17,0	18,5	23,5	34,0	33,0	75,0
OFCTL27	17,0	21,0	26,5	38,0	40,0	90,0
OFCTL28	21,0	21,0	26,5	38,0	40,0	90,0
OFCTL29	17,0	23,5	30,0	43,0	44,0	98,0
OFCTL30	21,0	23,5	30,0	43,0	44,0	98,0
OFCTL31	17,0	28,5	36,5	50,1	46,0	110,0
OFCTL32	21,0	28,5	36,5	50,1	46,0	110,0
OFCTL33	17,0	30,0	39,0	56,0	50,0	120,0
OFCTL34	21,0	30,0	39,0	56,0	50,0	120,0
OFCTL35	21,0	35,0	45,0	65,0	56,0	140,0
OFCTL36	-	39,0	50,6	73,5	60,0	170,0
OFCTL37	-	43,0	56,2	81,0	87,0	200,0



### Marcadores de cable / Cable markers

Marcadores elásticos reposicionables para la identificación de cables  
Elastic markers that can be repositioned and used to identify cables



Referencia Reference	Cable aprox. Approx. cable (mm)	Tipo de marcador Type of marker
OFCM2.0*	2,0 - 3,2	0-9 / A-Z / + - Λ
OFCM3.0*	3,0 - 4,2	0-9 / A-Z / + - Λ
OFCM3.6*	3,6 - 7,4	0-9 / A-Z / + - Λ
OFCM5.2*	5,2 - 10,0	0-9 / A-Z / + - Λ

\* = Reemplazar con / Replace with:  
0, 1, 2 ..... 9 = para indicador numérico / for numeric indicator  
A, B, C ..... Z = para indicador alfabético / for alpha indicator  
+, -, /, \ = para indicador de signo / for sign indicator

### Marcadores de cable (plano) / Cable markers (flat)

Marcadores elásticos reposicionables para la identificación de cables  
Elastic markers that can be repositioned and used to identify cables



Referencia Reference	Cable aprox. Approx. cable (mm)	Tipo de marcador Type of marker
OFFM28*	2 - 8	0-9 / A-Z / + - Λ

\* = Reemplazar con / Replace with:  
0, 1, 2 ..... 9 = para indicador numérico / for numeric indicator  
A, B, C ..... Z = para indicador alfabético / for alpha indicator  
+, -, /, \ = para indicador de signo / for sign indicator

### Marcadores de cable (tiras) / Cable markers (strips)

Tiras de nylon, con agujeros para el uso de bridas de sujeción, para acomodar marcadores de cable, referencia OFFM28, para la identificación de tendidos de cable

Nylon plates, with cable tie fastening holes, to accommodate marker pieces (reference: OFFM28), for easy identification of cable runs

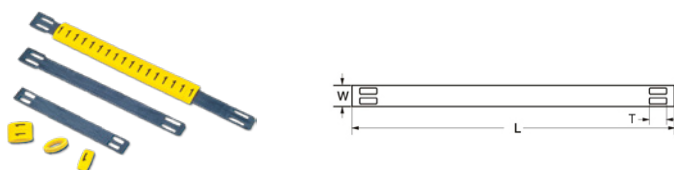

Referencia Reference	Medidas / Dimensions (mm)			Capacidad Capacity
	L	W	T	
OFMS65	65	9,0	6,0	9 pcs
OFMS100	100	9,0	6,0	16 pcs
OFMS135	135	9,0	7,0	23 pcs

### Marcadores de cable OM / OM Cable markers

Para el marcaje y organización de cableados  
For marking and organizing cable runs



Referencia Reference	Cable aprox. Approx. cable (mm)	Largo Length (mm)	Tipo de marcador Type of marker
OFOM3.0*	2,0 - 3,2	10,0	0-100 / A-Z / + - Λ
OFOM3.2*	3,0 - 4,2	10,0	0-100 / A-Z / + - Λ
OFOM3.6*	3,6 - 7,4	10,0	0-100 / A-Z / + - Λ
OFOM4.2*	5,2 - 10,0	10,0	0-100 / A-Z / + - Λ
OFOM5.1*	5,1	10,0	0-100 / A-Z / + - Λ
OFOM6.2*	6,2	10,0	0-100 / A-Z / + - Λ

\* = Reemplazar con / Replace with:  
0, 1, 2 ..... 9 = para indicador numérico / for numeric indicator  
A, B, C ..... Z = para indicador alfabético / for alpha indicator  
+, -, /, \ = para indicador de signo / for sign indicator

## Envolvente de cable espiral / Spiral wrapping bands

Para el marcaje, organización y protección de cableados  
For marking, organizing and protect cable runs

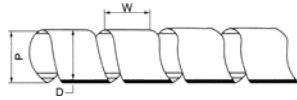

Referencias References	Medidas / Dimensions (mm)			
	P	D	W	Rango Range
OFWB06*	4,0	6,0	7,0	4,0 - 50
OFWB08*	6,0	8,0	10,8	6,0 - 60
OFWB10*	7,5	10,0	11,4	7,5 - 60
OFWB12*	9,0	12,0	13,9	9,0 - 65
OFWB15*	12,0	15,0	15,0	12,0 - 75
OFWB19*	15,0	19,0	18,2	15,0 - 100
OFWB24*	20,0	24,0	19,6	20,0 - 130

\* = Reemplazar con / Replace with:

A = para Azul / for Blue - B = para negro / for Black

G = para Gris / for Grey - V = para Verde / for Green

R = para Rojo / for Red - Y = para Amarillo / for Yellow

CE UNE EN 62275  
RoHS

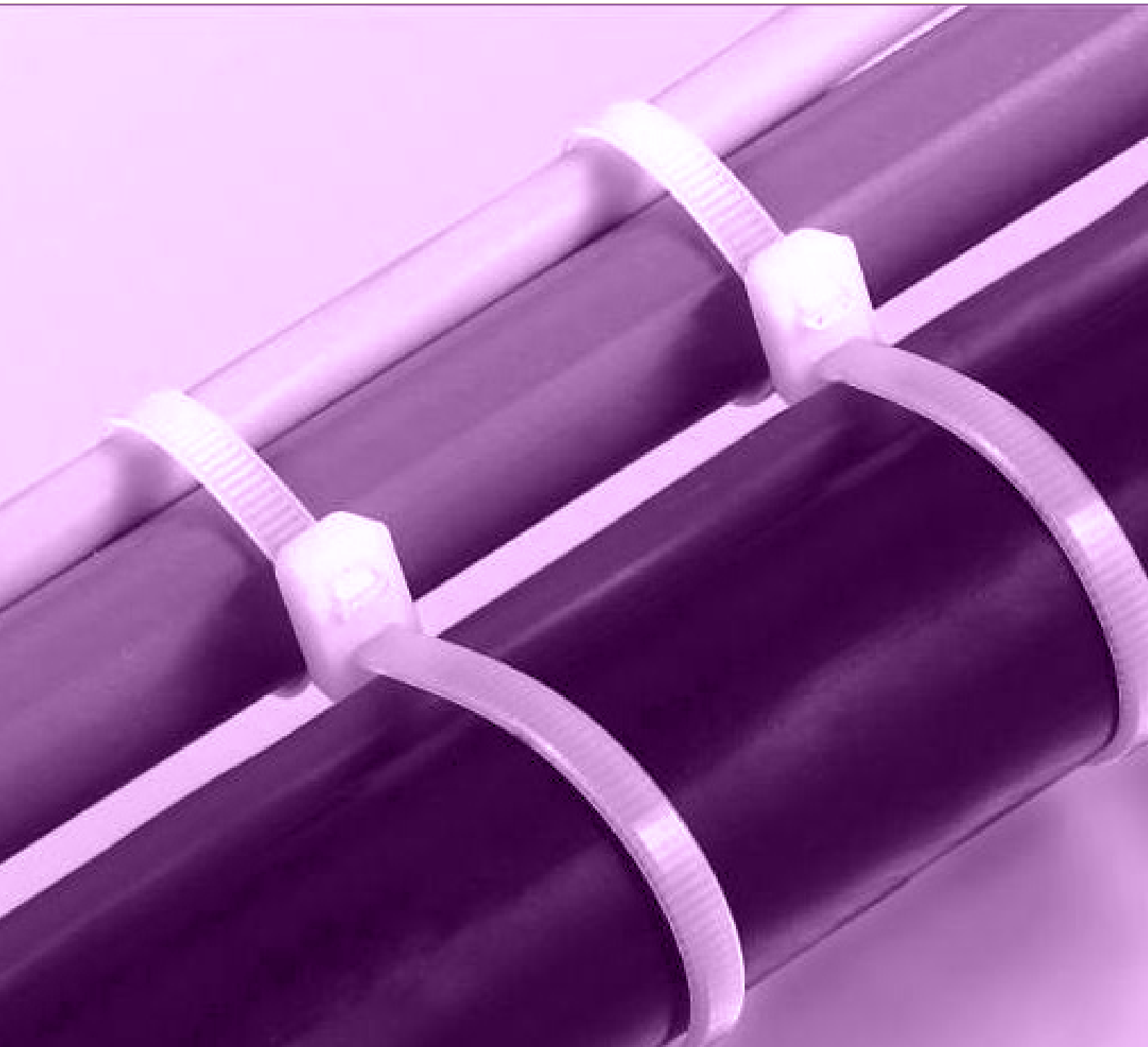



## Indices de protección Protection index





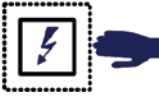
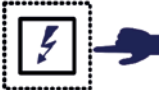
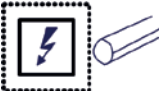
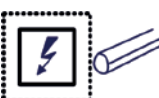

### Protección contra cuerpos sólidos y líquidos Protection against solid and liquid bodies

Grados de protección de las envolturas de equipos eléctricos según Norma UNE EN 60529:2018  
Protection of enclosures of electrical equipment in accordance with Standard UNE EN 60529:2018

#### 1ª Cifra: Protección contra los cuerpos sólidos 1st Figure: Protection against solid bodies

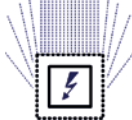
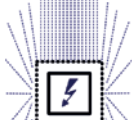
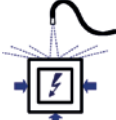

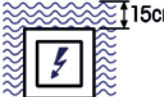

IP			
0	Sin protección	No protection	
1	Protegido contra los cuerpos sólidos superiores a 50mm (ej.: contactos involuntarios de la mano)	Protected against solid bodies larger than 50mm (eg.: accident contact with the hand)	
2	Protegido contra los cuerpos sólidos superiores a 12,5mm (ej.: dedos de la mano)	Protected against solid bodies larger than 12,5mm (eg.: finger)	
3	Protegido contra los cuerpos sólidos superiores a 2,5 mm (ej.: herramientas, cables)	Protected against solid bodies larger than 2,5mm (eg.: tools, wires)	
4	Protegido contra los cuerpos sólidos superiores a 1mm (ej.: herramientas finas, pequeños cables)	Protected against solid bodies larger than 1mm (eg.: fine tools and small wires)	
5	Protegido contra el polvo (sin sedimentos perjudiciales)	Protected against dust (with no harmful deposits)	
6	Totalmente protegido contra el polvo	Completely protected against dust	





#### 2ª Cifra: Protección contra los cuerpos líquidos 2nd Figure: Protection against solid liquids

IP			
0	Sin protección	No protection	
1	Protegido contra las caídas verticales de gotas de agua (condensación)	Protected against vertically falling drops of water (condensation)	
2	Protegido contra las caídas de agua hasta 15° de la vertical	Protected against drops of water falling at up to 15°	
3	Protegido contra el agua de lluvia hasta 60° de la vertical	Protected against drops of rain water at up to 60° from the vertical	
4	Protegido contra las proyecciones de agua en todas las direcciones	Protected against projections of water from all directions	
5	Protegido contra lanzamiento de agua en todas las direcciones	Protected against jets of water from all directions	
6	Protegido contra el lanzamiento de agua similar a los golpes de mar	Protected against jets of water of similar force of heavy seas	
7	Protegido contra inmersión	Protected against the effects of immersion	
8	Protegido contra los efectos prolongados de inmersión sobre presión	Protected against prolonged effects of immersion under pressure	

### Grados de protección proporcionados por las envolturas (Código IK) según Norma UNE-EN 50102

#### Protection provided by enclosures (Code IK) in accordance with Standard UNE-EN 50102

IK	Energía de impacto en Julios Impact energy in Joules	
00	Ninguna protección	No protection
01		0,15
02		0,2
03		0,35
04		0,5
05		0,7

IK	Energía de impacto en Julios Impact energy in Joules	
06		1
07		2
08		5
09		10
10		20

## Ensayos relativos a los riesgos de incendio Tests related to fire risks

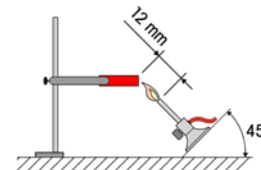
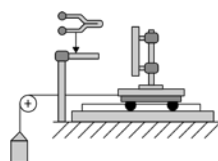
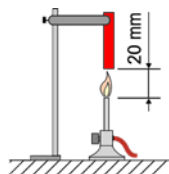

TIPO DE PRUEBA TYPE OF TEST	UL	ENSAYO DEL HILO INCANDESCENTE GLOW-WIRE TEST	ENSAYO DE LA LLAMA DE AGUJA "NEEDLE" FLAME TEST
Correspondencia normativa <i>Corresponding norm</i>	UL94	UNE-EN 60695-2-10	UNE-EN 60695-2-2
Objetivo de la prueba <i>Test objective</i>	<p>Se suministra una clasificación de los diferentes comportamientos que los materiales pueden tener después del contacto con la llama Bunsen.</p> <p><i>To classify the different material behaviours after contact with a flame from a Bunsen burner</i></p>	<p>Simula los efectos térmicos que pueden producirse de fuentes de calor anormal de fuego durante cortos periodos de tiempo, de manera que se pueda valorar, mediante una simulación, el riesgo de incendio.</p> <p><i>Simulates thermal effects produced by abnormal heat sources of fire during short periods, therefore simulating risk of fire.</i></p>	<p>Simula el efecto de pequeñas llamas que pueden manifestarse por condiciones de daño en el interior de los productos con el objetivo de juzgar el riesgo de incendio.</p> <p><i>Simulates the effect of small flames which could be caused by damage in the interior of products, with the objective of establishing the risk of fire.</i></p>
Resultado de la prueba <i>Test results</i>	<ul style="list-style-type: none"> <li>- V0 si la muestra se quema medianamente durante menos de 5 segundos antes de autoextinguirse. <i>V0 if the sample burns for less than 5 seconds before self-queching.</i></li> <li>- V1 si se quema medianamente durante menos de 25 segundos. <i>V1 if the sample burns for less than 25 seconds.</i></li> <li>- V2 si se quema durante menos de 25 segundos con goteado incandescente. <i>V2 if the sample burns for less than 25 seconds and drips.</i></li> <li>- HB si se quema en un tiempo mayor de 25 segundos. <i>HB if the sample burns after more than 25 seconds.</i></li> </ul>	<p>La eventual manifestación de la llama dentro de los 30 segundos siguientes a la retirada del hilo incandescente.</p> <p>TEMPERATURAS DE PRUEBA: - 650°C - 750°C - 850°C - 960°C</p> <p>Las posibles gotas incandescentes no deben prender el papel.</p> <p><i>Any flame should extinguish within a 30second period from the removal of the glow-wire at the corresponding temperature.</i></p> <p>TEST TEMPERATURES: - 650°C - 750°C - 850°C - 960°C</p> <p><i>Any drips must not light paper.</i></p>	<ul style="list-style-type: none"> <li>- El ejemplar no se incendia . <i>The sample does not catch fire</i></li> <li>- La llama y las partículas incandescentes no propagan el incendio . <i>The flame and glowing particles must not cuase fire</i></li> <li>- La duración de la combustión es inferior a 30 segundos después de la separación del mechero Bunsen. <i>The duration of combustion is less than 30 seconds after removal of the Bunsen burner.</i></li> </ul>
Fuente de calor <i>Heat source</i>	Llama a mechero Bunsen. <i>Flame from a Bunsen burner.</i>	Hilo incandescente de 4mm de diámetro. <i>4mm ø glow-wire</i>	Llama a mechero Bunsen. <i>Flame from a Bunsen burner.</i>
Duración de la prueba <i>Test duration</i>	Llama aplicada durante 10 segundos y dos veces consecutivas. <i>Applied flame for 10 seconds, twice consecutively.</i>	Hilo aplicado durante 30 segundos. <i>Glow-wire applied for 30 seconds.</i>	Llama aplicada por el tiempo (Ta) 5, 10, 20, 30, 60, 120 segundos según las normas particulares. <i>Flame applied for time (Ta) 5, 10, 20, 30, 60, 120 seconds depending on applicable norm.</i>
Elementos característicos <i>Characteristic elements</i>	Duración de la combustión. <i>Duration of combustion.</i>	Tiempo de apagado de la llama. <i>Time for flame to extinguish.</i>	El grado de severidad: tiempo de aplicación de la llama (Ta). <i>Degree of severity: Time that the flame is applied (Ta).</i>

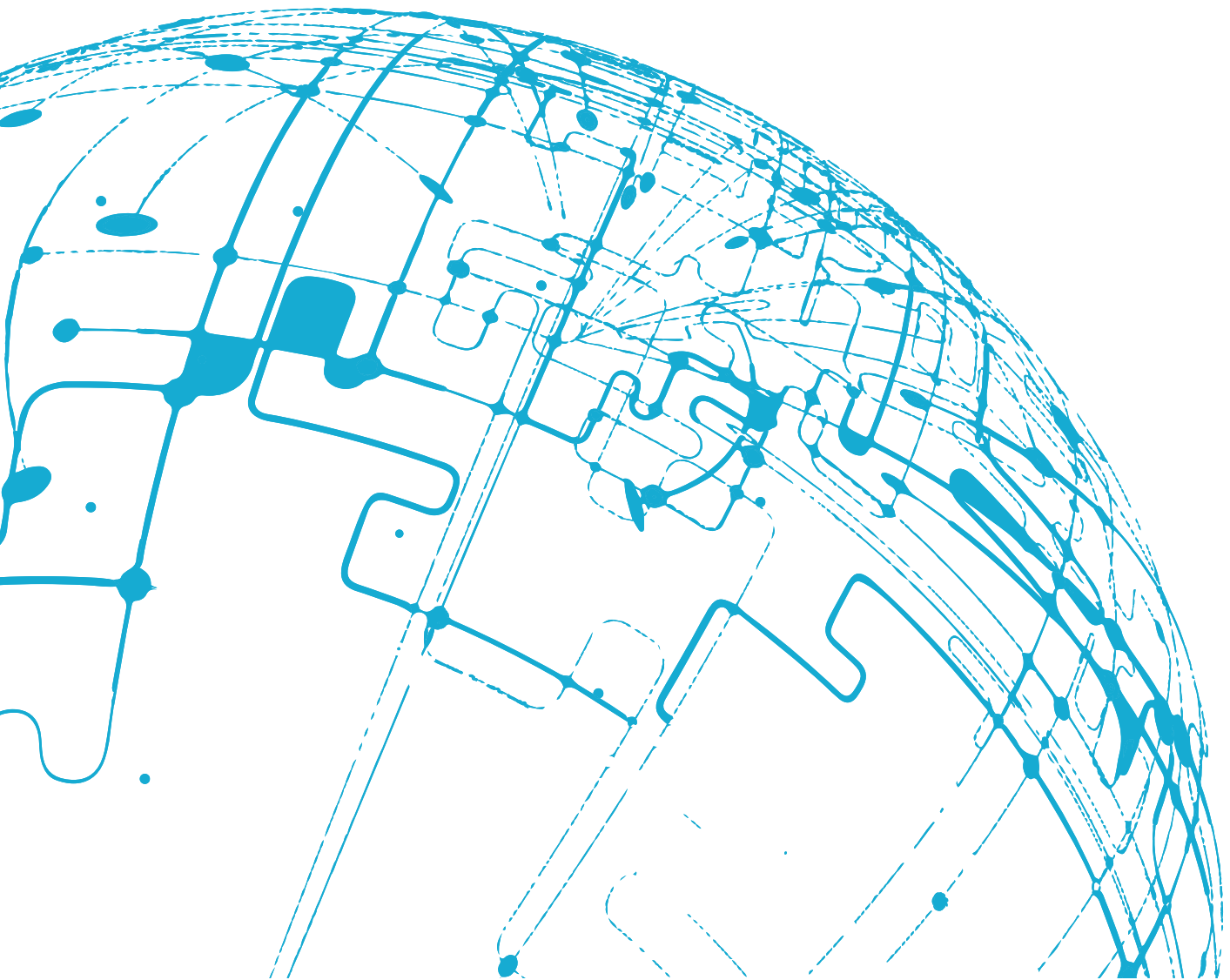

**OMNIUM**  
ELECTRIC  
Omnium Electric Iberia, S.L.  
info@omnium-electric.com  
www.omnium-electric.com